



Power

P. 07
DMX³ ACB from
630 A to 6300 A
Fixed version

P. 08
DMX³ ACB from
630 A to 6300 A
Draw out version

P. 09
DMX³ ACB,
Protection Units,
Terminal Adapters
& Conversion Kits

P. 13
Auxillaries &
Accessories

P. 16
DRX MCCBs

P. 17-31
DPX³ MCCBs &
Accessories

P. 42-43 **NEW!**
E-Communicating
Infrastructure

P. 44 **NEW!**
Power Supply

P. 46-48 **NEW!**
PMX
Digital Panel Meter

P. 63
ALPX³ resin filled
capacitors standard
and heavy duty
440 V, 480 V & 525 V

P. 63
Alpican gas filled
capacitors
Heavy duty 440 V

P. 63
Alpx³ box type
capacitors standard
and heavy duty
440 V



**Protection,
Isolation,
Controlling,
Signalling,
Metering.**

P. 68-72
DX³ MCB
Isolator
RCDs

P. 72
DX³
Accessories
and Auxillaries

P. 73
DX³ RCD
add-on module
with metering

P. 77
Lexic dimmer and
Power contactors

P. 77
Lexic
Time delay
relay

P. 77
Time switches and
Accessories



**Distribution
Boards**

P. 81
Ekinox³
ETPN DBs

P. 81-82
Ekinox³
TPN DB-VTPN

P. 82
Ekinox³
TPN DB-Phase Selector

P. 84
Ekinox³
Cable end box,
Meter box, PPT Kit
& Accessories

P. 85
Ekinox³ DBs
Plexo 3 boxes for
DX³ and Accessories



**Arteor™
Wiring
Accessories**

P. 103
Switches, Push buttons,
Dimmers, Regulators,
Indian standard sockets
square white

P. 104
USB Chargers, Data & voice, Hotel
funtions, Audio Video, Energy
plugs, USB Charger, RJ11 Telephone
Sockets, Information outlets

P. 109-110
Switches, Push
buttons, Dimmers &
Regulators, Round
White Mechanism

P. 110
Switches,
Push buttons

P. 110
Dimmers &
Regulators
Round Magnesium
Mechanism

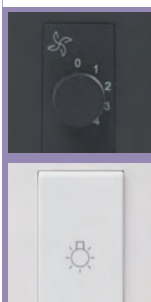

**Myrius™
Wiring
Accessories**

P. 120
Switches,
Push buttons, Sockets,
Power units and
Dimmer and regulators
White mechanisms

P. 121
ELU / Indicators,
Skirting light, Indicators,
Buzzors, Sensors and
Remote unit

P. 121
Hospitality
functions, Sockets
& connectors,
Data & voice

P. 123
Dimmer &
regulators, Switches,
Push buttons,
Black mechanisms

P. 124
ELU / Indicators,
Skirting light,
Indicators, Buzzors
& Sensor

P. 124
Remote unit,
Hospitality functions,
Sockets & connectors,
Data & voice



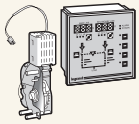

P. 10
Auxiliaries & Accessories

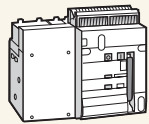

P. 12
DMX SP 2500 ACB
630 A to 2500 A
Fixed version
Draw-out version

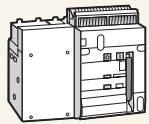

P. 12
DMX SP 2500 Switch
disconnectors 630 A
to 2500 A Fixed ver-
sion Draw-out version



P. 13
DMX SP 2500
Protection Units



P. 34-37 NEW!
DRX 250^{HP}
& 630
MCCBs & Accessories

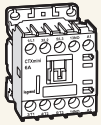

P. 50-52
CTX³
contactors

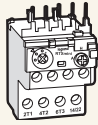

P. 53
RTX³
thermal relays

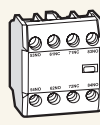

P. 55-56
CTX³
accessories



P. 57-59
MPX³ & MPX³
Accessories



P. 63-64
Reactors and
power factor con-
trollers

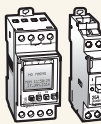

P. 73
DX³
Time switches
and Contactors

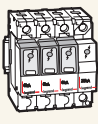

P. 74-75
SPD

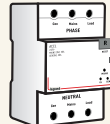

P. 77 NEW!
ACCL

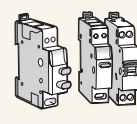

P. 77
DX³ changeover
switches,
Push buttons and
Indicators



P. 77
Time lag switches



P. 83
Ekinox³
TPN DB-
7 Segment DBs



P. 83
Ekinox³
P17 Tempra Plug
& Socket DBs



P. 83
Ekinox³ Metra
Plug & Socket
DBs



P. 84
Ekinox³
Metal
Enclosures



P. 105
Accessories
Square Mechanism

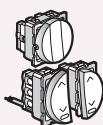

P. 106
Indian standard
sockets,
USB Chargers,
Data & voice

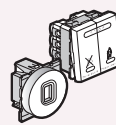

P. 107-109
Hotel Functions
Square Champagne
& Round White
Mechanism

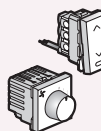

P. 110-111
Switches, Push
buttons, Dimmers &
Regulators, Plates
Round Champagne
Mechanism

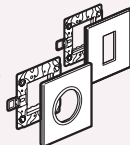

P. 111-115
Square cover plates,
Round cover plates

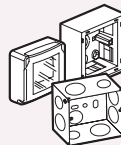

P. 115
Plastic surface,
Metal flush boxes,
Plexo boxes &
Accessories



P. 121
USB chargers
and Audio
& video connectors

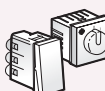

P. 121
Switches,
Push buttons,
Sockets,
Power units

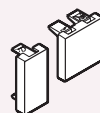

P. 122
Anti-Bacterial
Switches and
Accessories

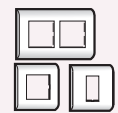

P. 124-125
White plastic
plates



P. 124
USB chargers
and Audio & video
connectors

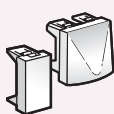

P. 124
Volume controller,
Protectors and
Accessories,
Modular MCBs

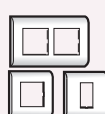

P. 125
White & Black
plastic plates

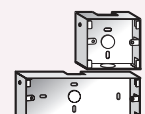

P. 125
Flush mounting &
Surface boxes

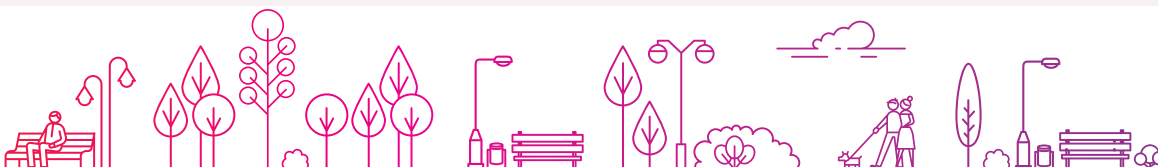

(Contd....)



**Mylic™
Wiring
Accessories**



P. 129
Mylic switches,
Dimmers and
Accessories USB
charger and remote unit

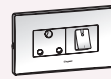

P. 129
Mylic energy
sockets, Power
units and MCBs

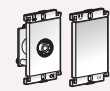

P. 129
Mylic TV and RJ 11
telephone sockets
and Accessories



P. 130
Mylic switches,
Dimmers, USB
charger, Remote unit
& Accessories

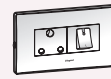

P.130-131
Mylic energy
sockets,
Power units and
MCBs

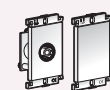

P. 131
Mylic TV,
RJ 11 Telephone
Sockets &
Accessories



**Lyncus™
Wiring
Accessories**

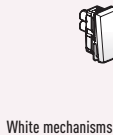

P. 135
Switches,
Push buttons,
Indian Standard
Sockets



P.135
Dimmer and
regulators,
Hospitality
Functions



P.136
Data voice,
Pre terminated
audio video
connectors



P. 136-137
Switches,
Push buttons,
Dimmer and regulators,
Accessories



P.137
Hospitality
Functions,
Data voice,
Pre terminated



P. 137
Audio Video
Connectors, USB
chargers: Combi
Sockets + USB



**Britzy™
Wiring
Accessories**

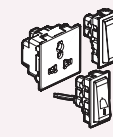

P. 141-142
Britzy Switches,
sockets and push
buttons

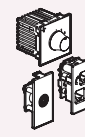

P. 141
Britzy Data & voice,
television sockets,
dimmers & regulators
& accessories

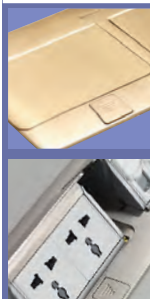

**Cable
Management
System and
Accessories**

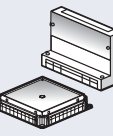

P. 146
Raceways & junction
boxes for screed
floors PVC, Metal
and Accessories

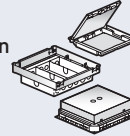

P. 146-147
Floor boxes for
raised floor, Screed
floor and tile/marble,
Support Plates

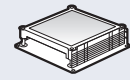

P. 147-150
Heavy Duty in-screed
floor box, Floor Boxes
3 module, Floor access
unit for raised floors



P. 157
Selection Chart:
DLP Mini Trunking
Systems



P. 158
Selection Chart :
DLP aluminium
Trunking system

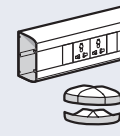

P. 160
Snap-On Trunking
45 mm, Routing
sections and
Accessories



**VDI
Structured
Cabling**

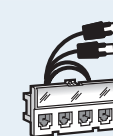

P. 165
LCS³,
cat. 8 Patch
Panels

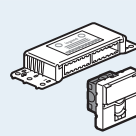

P. 165
LCS³,
cat. 8 Cables
and Cords

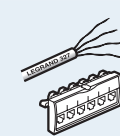

P. 165-169
LCS³,
cat. 6A Patch
panels, RJ 45,
Cables and Cords

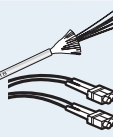

P. 176
LCS³,
Audio/Video
patch panel chord
cables

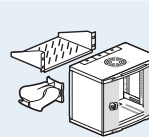

P. 177
Modular Panels
cassettes for LCS³
fibre optic drawers

P. 177
LCS³ pigtails, case
and quick-connect
connectors



**Movement
Detectors and
Door Phones**



P. 183
Movement
detectors



P. 183
Video door entry
system



**P17 Tempra Pro,
Hypra and
Plugs & Sockets**

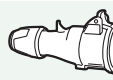

P. 190-191
P17 Tempra Pro
sockets



P. 190-191
P17 Tempra Pro
plugs

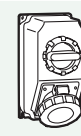

P. 190-191
P17 Tempra Pro
for refrigerated
container





P. 130
Mylinc
Modular Plates -
White



P. 131
Mylinc modular plates-
Matt Grey, Pearl white,
Champagne, Silver Alu,
Dark Bronze

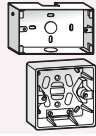

P. 132
Mylinc white
surrounds,
Flush & Surface
boxes



P. 136
USB Chargers:
Combi sockets + USB,
Wireless charger



P.136
sound diffusion
and loud speakers, Universal
dimmers, touch switches,
reading lights



P. 138
Plate & Frame
Chic grey, Brushed
silver, Alu sunset,
Champagne, Matt silver

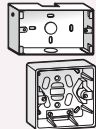

P. 138
Metal Flush box &
Plastic surface
boxes



P. 142 NEW!
Britzy white plate, warm orange
silver, herb beige, urban bronze,
orange chrome with frame

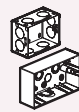

P. 143
Britzy Flush & sur-
face mounting boxes

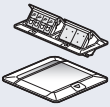

P. 150-151
Pop-up type flush-
mounting boxes,
Power & Data desk
grommets



P. 151
Flush Mounting
Power & data
module



P. 154
Selection Chart:
Snap-On trunking



P. 156
Selection chart:
DLP PVC
adaptable trunking
system

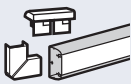

P. 160-161
DLP PVC Trunking
System, Trunking,
Mini-Trunking and
Accessories

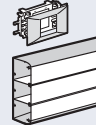

P. 162
DLP-S
PVC Trunking
system and Trunking
Accessories

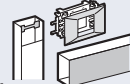

P. 162-163
DLP Aluminium
Adaptable Trunking
System, Aluminium
Snap-on columns

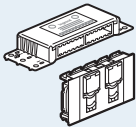

P. 170-172
LCS³,
cat. 6 Patch
Panels, RJ 45,
Cables and Cords

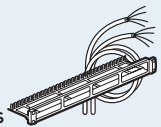

P. 172-175
LCS³,
cat. 5e Patch
panels, Cables
and Cords, RJ45

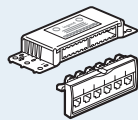

P. 175
LCS³,
cat. Splitter
sockets, adapters
and accessories



P. 175-176
LCS³, Audio/Video
Preterminated
sockets

P. 177-178
LCS³ High Density
and Very High
Density drawers
and cassettes

P. 179-180
LCS³
Preterminated
fibre optic and
cable solutions

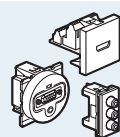

P. 180
9" fibre optic
drawers, LCS³
fibre optic blocks

P. 181
Patch chords



P. 192
Hypra industrial
plugs and sockets



AIR CIRCUIT BREAKERS

DMX³

EFFICIENT
PROTECTION
UP TO 6300 A



MP6 LSI/LSIg TOUCH SCREEN PROTECTION UNIT



ON
BUTTON

LEDs INDICATING CORRECT
OPERATION, PRE-ALARM
AND ALARM FOR OVERLOAD
AND TEMPERATURE

SETTINGS
LOCK

MINI USB
PORT FOR PC
CONNECTION

Innovative and user friendly touch screen tripping units

DMX³ Air Circuit Breakers



- Range – 630 A to 6300 A
- Three Optimum Frame Sizes
- Breaking Capacities of 50 kA, 65 kA & 100 kA
- Advanced Self Powered Electronic Protection Units
- Options for LSI and LSIG Trip Units
 - L : Ir – 0.4 to 1 In , tr – 5 to 30 sec
 - S : Isd – 1.5 to 10 Ir , tsd – 0.1 to 1 sec
 - I : Ii – 2 to 15 In
 - G : 0.2 to 1 In , tg – 0.1 to 1 sec
- Options of LCD and Touch Screen Multi Colour Displays
- Neutral Overload Protection – OFF-50 %-100 %
- Communication Ready
- In Built Temperature Protection
- Rotatable Terminals for Horizontal/Vertical Orientation
- Fast Operation
- Options to install various safety interlock
- Internal Battery for Trip Units
- Individual fault diagnosis
- Individual Fault Counter & Historical Trip Record
- Option to add 6 Programmable Digital Relay Contacts with Time Delay Changeover
- Option to Measure Current, Voltage, Frequency, Power, Energy, Power Factor and internal battery voltage
- Advanced Functions of Logical Selectivity, Reverse Power, Current Unbalance, Overvoltage, Undervoltage, Voltage Unbalance, Under Frequency, Over Frequency & Phase Reversal

| Type and frame size | Rated Current (A) | 3P | | | 4P | | |
|---------------------|-------------------|---------|-------------|------|---------|-------------|------|
| | | Cat.Nos | MRP*/₹/Unit | Pack | Cat.Nos | MRP*/₹/Unit | Pack |

Fixed Version

| | | | | | | | |
|---|--------|---------|---|---|---------|---|---|
| DMX ³ - N 2500, Icu 50 kA Frame - 1 | 630 A | 0286 20 | ■ | 1 | 0286 30 | ■ | 1 |
| | 800 A | 0286 21 | ■ | 1 | 0286 31 | ■ | 1 |
| | 1000 A | 0286 22 | ■ | 1 | 0286 32 | ■ | 1 |
| | 1250 A | 0286 23 | ■ | 1 | 0286 33 | ■ | 1 |
| | 1600 A | 0286 24 | ■ | 1 | 0286 34 | ■ | 1 |
| | 2000 A | 0286 25 | ■ | 1 | 0286 35 | ■ | 1 |
| | 2500 A | 0286 26 | ■ | 1 | 0286 36 | ■ | 1 |
| DMX ³ -N 4000 Icu 50 kA Frame - 2 | 3200 A | 0286 27 | ■ | 1 | 0286 37 | ■ | 1 |
| | 4000 A | 0286 28 | ■ | 1 | 0286 38 | ■ | 1 |
| DMX ³ - H 2500, Icu 65 kA Frame - 1 | 630 A | 0286 40 | ■ | 1 | 0286 50 | ■ | 1 |
| | 800 A | 0286 41 | ■ | 1 | 0286 51 | ■ | 1 |
| | 1000 A | 0286 42 | ■ | 1 | 0286 52 | ■ | 1 |
| | 1250 A | 0286 43 | ■ | 1 | 0286 53 | ■ | 1 |
| | 1600 A | 0286 44 | ■ | 1 | 0286 54 | ■ | 1 |
| | 2000 A | 0286 45 | ■ | 1 | 0286 55 | ■ | 1 |
| | 2500 A | 0286 46 | ■ | 1 | 0286 56 | ■ | 1 |
| DMX ³ -H 4000 Icu 65 kA Frame - 2 | 3200 A | 0286 47 | ■ | 1 | 0286 57 | ■ | 1 |
| | 4000 A | 0286 48 | ■ | 1 | 0286 58 | ■ | 1 |
| DMX ³ - L 2500, Icu 100 kA Frame - 2 | 630 A | 0286 60 | ■ | 1 | 0286 70 | ■ | 1 |
| | 800 A | 0286 61 | ■ | 1 | 0286 71 | ■ | 1 |
| | 1000 A | 0286 62 | ■ | 1 | 0286 72 | ■ | 1 |
| | 1250 A | 0286 63 | ■ | 1 | 0286 73 | ■ | 1 |
| | 1600 A | 0286 64 | ■ | 1 | 0286 74 | ■ | 1 |
| | 2000 A | 0286 65 | ■ | 1 | 0286 75 | ■ | 1 |
| | 2500 A | 0286 66 | ■ | 1 | 0286 76 | ■ | 1 |
| DMX ³ -L 4000 Icu 100 kA Frame - 2 | 3200 A | 0286 67 | ■ | 1 | 0286 77 | ■ | 1 |
| | 4000 A | 0286 68 | ■ | 1 | 0286 78 | ■ | 1 |
| DMX ³ -L 6300 Icu 100 kA Frame - 3 | 5000 A | 0289 50 | ■ | 1 | 0289 60 | ■ | 1 |
| | 6300 A | 0289 51 | ■ | 1 | 0289 61 | ■ | 1 |

■ Price available on request.

* MRP - Maximum Retail Price Inclusive of all taxes including GST.

Bold Cat.Nos are products normally available with Legrand (India) Stockists. Cat.Nos that are not bold - delivery within 4 - 8 weeks from the date of order. Bold packing quantity is our mandatory packing. Orders to be placed by Legrand (India) Stockist in multiples of the same.



0286 37



0286 56

DMX³ Air Circuit Breakers

| Type and frame size | Rated Current (A) | 3P | | | 4P | | |
|---------------------|-------------------|---------|-------------|------|---------|-------------|------|
| | | Cat.Nos | MRP*/₹/Unit | Pack | Cat.Nos | MRP*/₹/Unit | Pack |

Draw - Out Version

| | | | | | | | |
|---|--------|---------|---|---|---------|---|---|
| DMX ³ - N 2500, Icu 50 kA Frame - 1 | 630 A | 0287 20 | ■ | 1 | 0287 30 | ■ | 1 |
| | 800 A | 0287 21 | ■ | 1 | 0287 31 | ■ | 1 |
| | 1000 A | 0287 22 | ■ | 1 | 0287 32 | ■ | 1 |
| | 1250 A | 0287 23 | ■ | 1 | 0287 33 | ■ | 1 |
| | 1600 A | 0287 24 | ■ | 1 | 0287 34 | ■ | 1 |
| | 2000 A | 0287 25 | ■ | 1 | 0287 35 | ■ | 1 |
| | 2500 A | 0287 26 | ■ | 1 | 0287 36 | ■ | 1 |
| DMX ³ -N 4000 Icu 50 kA Frame - 2 | 3200 A | 0287 27 | ■ | 1 | 0287 37 | ■ | 1 |
| | 4000 A | 0287 28 | ■ | 1 | 0287 38 | ■ | 1 |
| DMX ³ - H 2500, Icu 65 kA Frame - 1 | 630 A | 0287 40 | ■ | 1 | 0287 50 | ■ | 1 |
| | 800 A | 0287 41 | ■ | 1 | 0287 51 | ■ | 1 |
| | 1000 A | 0287 42 | ■ | 1 | 0287 52 | ■ | 1 |
| | 1250 A | 0287 43 | ■ | 1 | 0287 53 | ■ | 1 |
| | 1600 A | 0287 44 | ■ | 1 | 0287 54 | ■ | 1 |
| | 2000 A | 0287 45 | ■ | 1 | 0287 55 | ■ | 1 |
| | 2500 A | 0287 46 | ■ | 1 | 0287 56 | ■ | 1 |
| DMX ³ -H 4000 Icu 65 kA Frame - 2 | 3200 A | 0287 47 | ■ | 1 | 0287 57 | ■ | 1 |
| | 4000 A | 0287 48 | ■ | 1 | 0287 58 | ■ | 1 |
| DMX ³ - L 2500, Icu 100 kA Frame - 2 | 630 A | 0287 60 | ■ | 1 | 0287 70 | ■ | 1 |
| | 800 A | 0287 61 | ■ | 1 | 0287 71 | ■ | 1 |
| | 1000 A | 0287 62 | ■ | 1 | 0287 72 | ■ | 1 |
| | 1250 A | 0287 63 | ■ | 1 | 0287 73 | ■ | 1 |
| | 1600 A | 0287 64 | ■ | 1 | 0287 74 | ■ | 1 |
| | 2000 A | 0287 65 | ■ | 1 | 0287 75 | ■ | 1 |
| | 2500 A | 0287 66 | ■ | 1 | 0287 76 | ■ | 1 |
| DMX ³ -L 4000 Icu 100 kA Frame - 2 | 3200 A | 0287 67 | ■ | 1 | 0287 77 | ■ | 1 |
| | 4000 A | 0287 68 | ■ | 1 | 0287 78 | ■ | 1 |
| DMX ³ -L 6300 Icu 100 kA Frame - 3 | 5000 A | 0289 52 | ■ | 1 | 0289 62 | ■ | 1 |
| | 6300 A | 0289 53 | ■ | 1 | 0289 63 | ■ | 1 |



0287 56

Switch Disconnecter (Trip Free Switches) from 1250 to 6300 A

Fixed Version

| | | | | | | | |
|---------------------------------------|--------|---------|---|---|---------|---|---|
| DMX ³ -I 2500 Frame - 1 | 1250 A | 0286 83 | ■ | 1 | 0286 93 | ■ | 1 |
| | 1600 A | 0286 84 | ■ | 1 | 0286 94 | ■ | 1 |
| | 2000 A | 0286 85 | ■ | 1 | 0286 95 | ■ | 1 |
| | 2500 A | 0286 86 | ■ | 1 | 0286 96 | ■ | 1 |
| DMX ³ -I 4000 Frame - 2 | 3200 A | 0286 87 | ■ | 1 | 0286 97 | ■ | 1 |
| | 4000 A | 0286 88 | ■ | 1 | 0286 98 | ■ | 1 |
| DMX ³ -I 6300 Frame - 3 | 6300 A | 0289 70 | ■ | 1 | 0289 71 | ■ | 1 |



0286 96

Draw - Out Version

| | | | | | | | |
|---------------------------------------|--------|---------|---|---|---------|---|---|
| DMX ³ -I 2500 Frame - 1 | 1250 A | 0287 83 | ■ | 1 | 0287 93 | ■ | 1 |
| | 1600 A | 0287 84 | ■ | 1 | 0287 94 | ■ | 1 |
| | 2000 A | 0287 85 | ■ | 1 | 0287 95 | ■ | 1 |
| | 2500 A | 0287 86 | ■ | 1 | 0287 96 | ■ | 1 |
| DMX ³ -I 4000 Frame - 2 | 3200 A | 0287 87 | ■ | 1 | 0287 97 | ■ | 1 |
| | 4000 A | 0287 88 | ■ | 1 | 0287 98 | ■ | 1 |
| DMX ³ -I 6300 Frame - 3 | 6300 A | 0289 77 | ■ | 1 | 0289 78 | ■ | 1 |



0287 96

* MRP - Maximum Retail Price Inclusive of all taxes including GST.
■ Price available on request.

Bold Cat.Nos are products normally available with Legrand (India) Stockists.
Cat.Nos that are not bold - delivery within 4 - 8 weeks from the date of order.
Bold packing quantity is our mandatory packing. Orders to be placed by Legrand (India) Stockist in multiples of the same.

DMX³

Electronic Protection Units

| Cat.Nos | Description | MRP*/₹/Unit | Pack |
|---------|-------------|-------------|------|
|---------|-------------|-------------|------|

Electronic Protection Units MP4

| | | | |
|---------|--|---|---|
| 0288 01 | Electronic Protection Unit with LCD screen with Im, tm, lr, tr and li adjustments on the front | ■ | 1 |
| 0288 02 | Electronic Protection Unit with LCD screen with Im, tm, lr, tr, li, lg and tg adjustments on the front | ■ | 1 |



0288 02

Electronic Protection Units MP6

| | | | |
|---------|--|---|---|
| 0288 03 | Electronic Protection Unit with Touch screen with Im, tm, lr, tr and li, adjustments on the front | ■ | 1 |
| 0288 04 | Electronic Protection Unit with Touch screen with Im, tm, lr, tr, li, lg and tg adjustments on the front | ■ | 1 |



0288 03

Accessories for Electronic Protection Units

| | | | |
|------------------------|---|---|---|
| 0288 10 | External neutral CT for DMX ³ 6300 | ■ | 1 |
| 0288 11 ⁽¹⁾ | External neutral CT | ■ | 1 |

| Type and frame size | 3P | | | 4P | | |
|---------------------|---------|-------------|------|---------|-------------|------|
| | Cat.Nos | MRP*/₹/Unit | Pack | Cat.Nos | MRP*/₹/Unit | Pack |

Fixed Version

| | | | | | | |
|--|----------|---|---|----------|---|---|
| DMX ³ 2500, fixed version, frame - 1 | 0288 84 | ■ | 1 | 0288 85 | ■ | 1 |
| | 0288 82 | ■ | 1 | 0288 83 | ■ | 1 |
| DMX ³ 4000, DMX ³ 6300 fixed version, frame - 2 & 3 | 0288 92 | ■ | 1 | 0288 93 | ■ | 1 |
| DMX ³ 2500 draw-out version, Frame - 1 | 0288 96 | ■ | 1 | 0288 97 | ■ | 1 |
| DMX ³ 4000, DMX ³ 6300 draw-out version, fram - 2 & 3 | 0288 94 | ■ | 1 | 0288 95 | ■ | 1 |
| DMX ³ 2500, draw-out version, frame-1 suitable for Aluminium | 0288 96A | ■ | 1 | 0288 97A | ■ | 1 |
| DMX ³ 4000, DMX ³ 6300 draw-out version, frame - 2&3, suitable for Aluminium | 0288 94A | ■ | 1 | 0288 95A | ■ | 1 |



0288 84



0288 82



0288 96

Spreaders

| | | | | | | |
|---|---------|---|---|---------|---|---|
| DMX ³ 2500, fixed version, frame - 1 | 0289 02 | ■ | 1 | 0288 87 | ■ | 1 |
| | 0288 88 | ■ | 1 | 0288 89 | ■ | 1 |
| | 0288 90 | ■ | 1 | 0288 91 | ■ | 1 |



0288 91

Equipment for conversion of a fixed device into draw-out device

Bases (cradle) for Draw-Out Device

| | | | | | | |
|---|---------|---|---|---------|---|---|
| DMX ³ /DMX ³ -I 2500, frame - 1 | 0289 02 | ■ | 1 | 0289 03 | ■ | 1 |
| DMX ³ /DMX ³ -I 4000, frame - 2 | 0289 04 | ■ | 1 | 0289 05 | ■ | 1 |
| DMX ³ /DMX ³ -I 6300, frame - 3 | 0289 13 | ■ | 1 | 0289 14 | ■ | 1 |

Transformation kit for Draw-Out Version

| | | | | | | |
|---|---------|---|---|---------|---|---|
| DMX ³ /DMX ³ -I 2500, frame - 1 | 0289 09 | ■ | 1 | 0289 10 | ■ | 1 |
| DMX ³ /DMX ³ -I 4000, frame - 2 | 0289 11 | ■ | 1 | 0289 12 | ■ | 1 |
| DMX ³ /DMX ³ -I 6300, frame - 3 | 0289 15 | ■ | 1 | 0289 16 | ■ | 1 |

* MRP - Maximum Retail Price Inclusive of all taxes including GST.

■ Price available on request.

(1) Optional accessories to be ordered while ordering electronic protection unit and DMX³ air circuit breakers for factory assembly

Bold Cat.Nos are products normally available with Legrand (India) Stockists. Cat.Nos that are not bold - delivery within 4 - 8 weeks from the date of order. Bold packing quantity is our mandatory packing. Orders to be placed by Legrand (India) Stockist in multiples of the same.

DMX³ Auxiliaries and Accessories

| Cat.Nos | Description | MRP* ₹ / Unit | Pack |
|---------|-------------|------------------|------|
|---------|-------------|------------------|------|

Control and signalling auxiliaries

Shunt trip

| | | | |
|---------|----------|---|---|
| 0288 48 | 24 V~/= | ■ | 1 |
| 0288 49 | 48 V~/= | ■ | 1 |
| 0288 50 | 110 V~/= | ■ | 1 |
| 0288 51 | 230 V~/= | ■ | 1 |
| 0288 52 | 415 V~ | ■ | 1 |



0288 51

Undervoltage Releases

| | | | |
|---------|----------|---|---|
| 0288 55 | 24 V~/= | ■ | 1 |
| 0288 56 | 48 V~/= | ■ | 1 |
| 0288 57 | 110 V~/= | ■ | 1 |
| 0288 58 | 230 V~/= | ■ | 1 |
| 0288 59 | 415 V~ | ■ | 1 |



0288 58

Undervoltage Releases with Relay

| | | | |
|---------|----------|---|---|
| 0288 62 | 110 V~/= | ■ | 1 |
| 0288 63 | 230 V~/= | ■ | 1 |

Motor operators

| | | | |
|---------|----------|---|---|
| 0288 34 | 24 V~/= | ■ | 1 |
| 0288 35 | 48 V~/= | ■ | 1 |
| 0288 36 | 110 V~/= | ■ | 1 |
| 0288 37 | 230 V~/= | ■ | 1 |
| 0288 38 | 415 V~ | ■ | 1 |



0288 37

Closing coils

| | | | |
|---------|----------|---|---|
| 0288 41 | 24 V~/= | ■ | 1 |
| 0288 42 | 48 V~/= | ■ | 1 |
| 0288 43 | 110 V~/= | ■ | 1 |
| 0288 44 | 230 V~/= | ■ | 1 |
| 0288 45 | 415 V~ | ■ | 1 |



0288 44

Locking

Key locking in "open" position

| | | | |
|---------|--------------------------------------|---|---|
| 0288 31 | Ronis lock (key included) | ■ | 1 |
| 0288 29 | Ronies key barrel | ■ | 1 |
| 0288 30 | Profalux lock (key included) | ■ | 1 |
| 0288 28 | 2 hole support frame for Ronis locks | ■ | 1 |

DMX³ Auxiliaries and Accessories

| Cat.Nos | Description | MRP* ₹ / Unit | Pack |
|---------|-------------|------------------|------|
|---------|-------------|------------------|------|

Locking

Key locking in the draw-out position

| | | | |
|---------|------------------------------|---|---|
| 0288 33 | Ronis lock (key included) | ■ | 1 |
| 0288 32 | Profalux lock (key included) | ■ | 1 |



0288 32
+
0288 33

Door locking

| | | | |
|---------|--|---|---|
| 0288 20 | Left-hand and right-hand side mounting | ■ | 1 |
|---------|--|---|---|

Padlocks in "open" position

| | | | |
|---------|--------------------------------|---|---|
| 0288 21 | Padlocking system for ACB | ■ | 1 |
| 0288 24 | Padlocking for button | ■ | 1 |
| 0288 26 | Padlocking system for shutters | ■ | 1 |

Automation control unit

| | | | |
|----------|----------------------|---|---|
| 4226 80 | Standard unit | ■ | 1 |
| 4226 82 | Advanced unit | ■ | 1 |
| 4226 89▼ | Communication module | ■ | 1 |



4226 82

Equipment for supply invertors

| | | | |
|---------|-------------------------------------|---|---|
| 0288 64 | Interlock for DMX ³ 2500 | ■ | 1 |
| 0288 65 | Interlock for DMX ³ 4000 | ■ | 1 |
| 0288 66 | Interlock for DMX ³ 6300 | ■ | 1 |



0288 64

Cable interlock

| | | | |
|---------|------------------|---|---|
| 0289 20 | Type 1 (2600 mm) | ■ | 1 |
| 0289 21 | Type 2 (3000 mm) | ■ | 1 |
| 0289 22 | Type 3 (3600 mm) | ■ | 1 |
| 0289 23 | Type 4 (4000 mm) | ■ | 1 |
| 0289 24 | Type 5 (4600 mm) | ■ | 1 |
| 0289 25 | Type 6 (5600 mm) | ■ | 1 |

Accessories

| | | | |
|---------|---|---|---|
| 0288 25 | Rating mis-insertion device | ■ | 1 |
| 0288 23 | Operations counter | ■ | 1 |
| 0288 13 | Inserted / test / Draw-out Contact | ■ | 1 |
| 0288 14 | Contact "ready to close" with charged springs | ■ | 1 |
| 0288 15 | Set of additional signalling contacts | ■ | 1 |
| 0288 16 | Signal Contact for Auxiliaries | ■ | 1 |
| 0288 22 | Door sealing IP 40 | ■ | 1 |
| 0288 79 | Lifting plate | ■ | 1 |

* MRP - Maximum Retail Price Inclusive of all taxes including GST.

■ Price available on request.

▼ For communication add 4226 82 + 4226 89

Bold Cat.Nos are products normally available with Legrand (India) Stockists. Cat.Nos that are not bold - delivery within 4 - 8 weeks from the date of order. Bold packing quantity is our mandatory packing. Orders to be placed by Legrand (India) Stockist in multiples of the same.

DMX SP2500

A SUPERIOR ACB IN
THE 630 A - 2500 A RANGE



SMART



ELECTRONIC
RELEASES
OFFERING PRECISE
PROTECTION

EFFICIENT



EASY
INSTALLATION

OPTIMIZED



GENEROUS
CLEARANCES



IN - BUILT
TEMPERATURE
PROTECTION



EASY
MAINTENANCE

DMX SP 2500 Air Circuit Breakers



- Range – 630 A to 2500 A
- Single Frame Size
- Options of Fixed and Drawout Versions
- Options of Manual & Electrical Versions
- Icu=Ics=Icw(1s)=50 kA
- Compact Dimensions
- Advanced Self Powered Electronic Protection Units
 - L : I_r – 0.4 to 1 I_n, t_r – 5 to 30 sec
 - S : I_{sd} – 1.5 to 10 I_r, t_{sd} – 0.1 to 1 sec
 - I : I_i – 2 to 15 I_n
 - G : I_g – 0.2 to 1 I_n, t_g – 0.1 to 1 sec
- Neutral Overload Protection - OFF-50 %-100 %
- In Built Temperature Protection
- Rotatable Terminals for Horizontal/Vertical Orientation
- Fast Operation
- Options to install various safety interlock

| Type and frame size | Rated Current (A) | 3P | | | 4P | | |
|---------------------|-------------------|---------|-------------|------|---------|-------------|------|
| | | Cat.Nos | MRP*/₹/Unit | Pack | Cat.Nos | MRP*/₹/Unit | Pack |

Fixed Version

| | | | | | | | |
|----------------------------|--------|---------|--------|---|---------|--------|---|
| DMX SP 2500 Icu = 50 kA | 630 A | 6695 24 | 85028 | 1 | 6695 30 | 118434 | 1 |
| | 800 A | 6695 25 | 85028 | 1 | 6695 31 | 118434 | 1 |
| | 1000 A | 6695 26 | 91100 | 1 | 6695 32 | 127546 | 1 |
| | 1250 A | 6695 27 | 107804 | 1 | 6695 33 | 148798 | 1 |
| | 1600 A | 6695 28 | 127546 | 1 | 6695 34 | 167024 | 1 |
| | 2000 A | 6695 29 | 152748 | 1 | 0286 35 | 200668 | 1 |
| | 2500 A | 6695 76 | ■ | 1 | 6695 77 | ■ | 1 |



6695 26



6695 31

Drawout version

| | | | | | | | |
|----------------------------|--------|---------|--------|---|---------|--------|---|
| DMX SP 2500 Icu = 50 kA | 630 A | 6695 36 | 109320 | 1 | 6695 42 | 142724 | 1 |
| | 800 A | 6695 37 | 109320 | 1 | 6695 43 | 142724 | 1 |
| | 1000 A | 6695 38 | 115400 | 1 | 6695 44 | 151838 | 1 |
| | 1250 A | 6695 39 | 132102 | 1 | 6695 45 | 173096 | 1 |
| | 1600 A | 6695 40 | 151838 | 1 | 6695 46 | 191316 | 1 |
| | 2000 A | 6695 41 | 188282 | 1 | 6695 47 | 223838 | 1 |
| | 2500 A | 6695 78 | ■ | 1 | 6695 79 | ■ | 1 |

Switch Disconnectors / Trip Free Switches

Fixed version

| | | | | | | | |
|-------------|--------|---------|--------|---|---------|--------|---|
| DMX SP 2500 | 630 A | 6695 48 | 85028 | 1 | 6695 54 | 118434 | 1 |
| | 800 A | 6695 49 | 85028 | 1 | 6695 55 | 118434 | 1 |
| | 1000 A | 6695 50 | 91100 | 1 | 6695 56 | 127546 | 1 |
| | 1250 A | 6695 51 | 107804 | 1 | 6695 57 | 148798 | 1 |
| | 1600 A | 6695 52 | 127546 | 1 | 6695 58 | 167024 | 1 |
| | 2000 A | 6695 53 | 152748 | 1 | 6695 59 | 200668 | 1 |
| | 2500 A | 6695 80 | ■ | 1 | 6695 81 | ■ | 1 |

Drawout version

| | | | | | | | |
|-------------|--------|---------|--------|---|---------|--------|---|
| DMX SP 2500 | 630 A | 6695 60 | 109320 | 1 | 6695 66 | 142724 | 1 |
| | 800 A | 6695 61 | 109320 | 1 | 6695 67 | 142724 | 1 |
| | 1000 A | 6695 62 | 115400 | 1 | 6695 68 | 151838 | 1 |
| | 1250 A | 6695 63 | 132102 | 1 | 6695 69 | 173096 | 1 |
| | 1600 A | 6695 64 | 151838 | 1 | 6695 70 | 191316 | 1 |
| | 2000 A | 6695 65 | 188282 | 1 | 6695 71 | 223838 | 1 |
| | 2500 A | 6695 82 | ■ | 1 | 6695 83 | ■ | 1 |



6695 68

■ Price available on request.

* MRP - Maximum Retail Price Inclusive of all taxes including GST.

Bold Cat.Nos are products normally available with Legrand (India) Stockists. Cat.Nos that are not bold - delivery within 4 - 8 weeks from the date of order. Bold packing quantity is our mandatory packing. Orders to be placed by Legrand (India) Stockist in multiples of the same.

DMX SP 2500

Electronic Protection Units

| Cat.Nos | Description | MRP* ₹ / Unit | Pack |
|---------|-------------|------------------|------|
|---------|-------------|------------------|------|

Electronic Protection Units

| | | | |
|---------|-------------------------------------|-------|---|
| 0281 67 | Electronic Protection Unit MP2 LSI | 19742 | 1 |
| 0281 68 | Electronic Protection Unit MP2 LSIg | 24294 | 1 |

Auxiliaries Accessories

Motor operator

| | | | |
|---------|--------------|-------|---|
| 0281 20 | 24 V~/= | 28848 | 1 |
| 0281 21 | 48 V~/= | 28848 | 1 |
| 0281 22 | 110-130 V~/= | 28848 | 1 |
| 0281 23 | 220-250 V~/= | 28848 | 1 |
| 0281 24 | 415-440 V~ | 28848 | 1 |

Closing coil

| | | | |
|---------|--------------|------|---|
| 0281 26 | 24 V~/= | 4860 | 1 |
| 0281 27 | 48 V~/= | 4860 | 1 |
| 0281 28 | 110-130 V~/= | 4860 | 1 |
| 0281 29 | 220-250 V~/= | 4860 | 1 |
| 0281 30 | 415-440 V~ | 4860 | 1 |

Shunt release

| | | | |
|---------|--------------|------|---|
| 0281 31 | 24 V~/= | 4860 | 1 |
| 0281 32 | 48 V~/= | 4860 | 1 |
| 0281 33 | 110-130 V~/= | 4860 | 1 |
| 0281 34 | 220-250 V~/= | 4860 | 1 |
| 0281 35 | 415-440 V~ | 4860 | 1 |

Undervoltage release

| | | | |
|---------|--------------|------|---|
| 0281 36 | 24 V~/= | 6376 | 1 |
| 0281 37 | 48 V~/= | 6376 | 1 |
| 0281 38 | 110-130 V~/= | 6376 | 1 |
| 0281 39 | 220-250 V~/= | 6376 | 1 |
| 0281 40 | 415-440 V~ | 6376 | 1 |

Undervoltage Release with Time Delay

| | | | |
|---------|----------|------|---|
| 0288 62 | 110 V~/= | 9170 | 1 |
| 0288 63 | 230 V~/= | 9170 | 1 |

Mechanical Accessories

Phase barriers / Insulated shields

| | | | |
|---------|----------------------------|---|---|
| 6696 00 | Fix Version 3P DMX SP | ■ | 1 |
| 6696 01 | Fix Version 4P DMX SP | ■ | 1 |
| 6696 02 | Draw-out Version 3P DMX SP | ■ | 1 |
| 6696 03 | Draw-out Version 4P DMX SP | ■ | 1 |

■ Price available on request.

* MRP - Maximum Retail Price Inclusive of all taxes including GST.

DMX SP 2500

Auxiliaries Accessories

| Cat.Nos | Description | MRP* ₹ / Unit | Pack |
|---------|-------------|------------------|------|
|---------|-------------|------------------|------|

Key lock

| | | | |
|---------|---|------|---|
| 0281 78 | Keylock in open position (1 lock 1 Ronis random) Frame 2500 | 3950 | 1 |
| 0281 79 | Keylock in open position (1 lock 1 Ronis type "A") Frame 2500 | 3950 | 1 |
| 0281 80 | Keylock in open position (1 lock 1 Ronis type "B") Frame 2500 | 3950 | 1 |
| 0281 81 | Keylock in open position - Profalux DMX SP | 3950 | 1 |
| 0281 82 | Keylock ins./test/drawnout - Profalux DMX SP | 3950 | 1 |
| 0281 83 | Keylock ins./test/drawnout - Ronis DMX SP | 3950 | 1 |
| 0281 84 | Door lock for both right & left handle Frame 2500 | 3950 | 1 |
| 0281 87 | Inserted/test/drawnout lock button | 1822 | 1 |

Terminals

| | | | |
|---------|---|------|---|
| 0288 84 | Real terminals - flat connections with bars | ■ | 1 |
| 0288 82 | Real terminals - vertical connections with bars | ■ | 1 |
| 0288 85 | Real terminals - flat connections with bars | ■ | 1 |
| 0288 83 | Real terminals - vertical connections with bars | ■ | 1 |
| 0288 96 | Real terminals - vertical or horizontal connection with bars to be fixed onto plate | 6548 | 1 |
| 0288 97 | Real terminals - vertical or horizontal connection with bars to be fixed onto plate | 8730 | 1 |

Additional Accessories

| | | | |
|---------|--------------------------------------|-------|---|
| 0281 88 | Mechanical Counter | 3040 | 1 |
| 0281 77 | Padlock for Button | 1212 | 1 |
| 6696 05 | Enternal Neutral | 5898 | 1 |
| 0281 73 | Signalling Contact inserted-test-D/O | 2428 | 1 |
| 0281 74 | AUX Ready to close-charged springs | 2428 | 1 |
| 0281 75 | Module with 6 aux contacts | 18220 | 1 |
| 0281 90 | Mechanical Interlock two device | 9742 | 1 |

Bold Cat.Nos are products normally available with Legrand (India) Stockists. Cat.Nos that are not bold - delivery within 4 - 8 weeks from the date of order. Bold packing quantity is our mandatory packing. Orders to be placed by Legrand (India) Stockist in multiples of the same.

DPX³

PRECISE PROTECTION
AND MEASUREMENT
UP TO 1600 A

TOTAL SELECTIVITY FOR OPTIMUM CONTINUITY OF SERVICE

DYNAMIC SELECTIVITY

Electronic DPX³ units have 2-position adjustment:

- Low for normal selectivity level
- High for high selectivity level

When electronic circuit breakers are set to High there is a slight tripping delay, enabling a high level of selectivity to be obtained, even for the highest short-circuit currents.

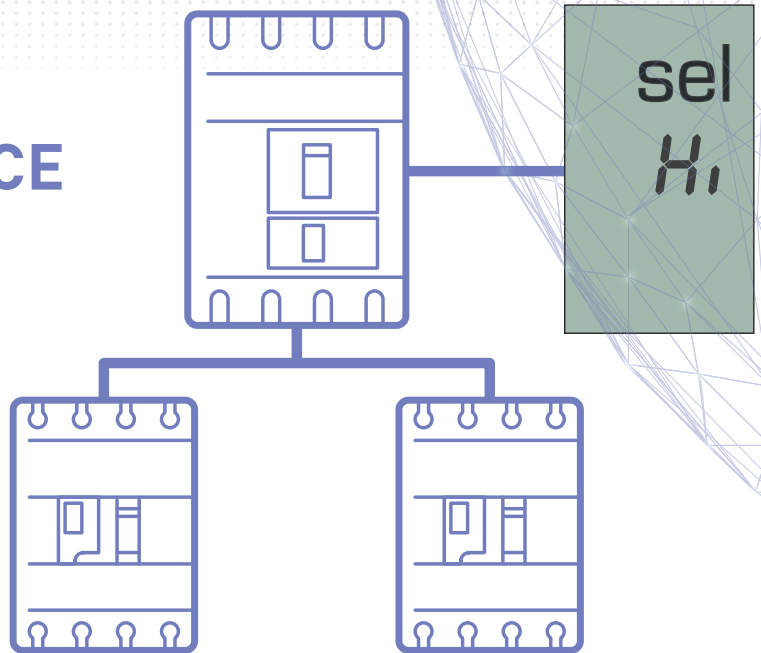

DPX³ 160



DPX³ 250



DPX³ 630



DPX³ 1600



Integrated measurement From 40 to 1600 A

The measurement data can also be viewed remotely on a PC equipped with supervision software, via a communication interface.



DRX™ MCCB

| Type and frame size | Rated Current (A) | Poles | Cat.Nos | MRP* ₹ / Unit | Pack |
|---------------------|-------------------|-------|---------|---------------|------|
|---------------------|-------------------|-------|---------|---------------|------|

DRX MCCBs

| | | | | | |
|------------------------|-------|--------|----------------|------|------|
| DRX 100 Icu = 10 kA | 63 A | 3 Pole | 0270 39 | 2480 | 1/12 |
| | 75 A | 3 Pole | 0270 07 | 2480 | 1/12 |
| | 100 A | 3 Pole | 0270 08 | 2480 | 1/12 |
| | 63 A | 4 Pole | 0270 29 | 3878 | 1/12 |
| | 75 A | 4 Pole | 0270 17 | 3878 | 1/12 |
| | 100 A | 4 Pole | 0270 18 | 3878 | 1/12 |

| Description | Cat.Nos | MRP* ₹ / Unit | Pack |
|-------------|---------|---------------|------|
|-------------|---------|---------------|------|

DIN rail adaptor

| | | | |
|---------|---------|-----|---|
| DRX 100 | 0271 87 | 396 | 1 |
|---------|---------|-----|---|

Rotary handles - Direct

| | | | |
|---------|---------|------|---|
| DRX 100 | 6687 70 | 1190 | 1 |
|---------|---------|------|---|

Rotary handles - vary-depth

| | | | |
|---------|---------|------|---|
| DRX 100 | 6687 71 | 2060 | 1 |
|---------|---------|------|---|

Padlocking support for operating handle

| | | | |
|---------|---------|-----|---|
| DRX 100 | 0271 80 | 132 | 1 |
|---------|---------|-----|---|

Connection accessories

| | | | |
|-----------------------------|---------|----|---|
| Set of 2 shields for 3 pole | 0271 81 | 94 | 1 |
|-----------------------------|---------|----|---|

Sealable terminal shields (moulded shrouds)

| | | | |
|----------------------|---------|------|---|
| For DRX 100 - 3 pole | 0271 83 | 1296 | 1 |
| For DRX 100 - 4 pole | 0271 84 | 1294 | 1 |

Cage terminals

| | | | |
|----------------------|---------|-----|---|
| For DRX 100 - 3 pole | 0271 71 | 252 | 1 |
| For DRX 100 - 4 pole | 0271 73 | 264 | 1 |

Electrical accessories

| | | | |
|---|---------|------|---|
| Block with 1 auxiliary (1 AUX) | 0271 40 | 822 | 1 |
| Block with 1 alarm (1 AL) | 0271 41 | 840 | 1 |
| Block with 1 auxiliary + 1 alarm (1 AUX + 1 AL) | 0271 42 | 1380 | 1 |

Current shunt coils

| | | | |
|------------------------|---------|------|---|
| 200/277 V \sim and = | 0271 54 | 1714 | 1 |
| 380/480 V \sim and = | 0271 55 | 1714 | 1 |

Undervoltage release coils

| | | | |
|------------------|---------|------|---|
| 200/240 V \sim | 0271 64 | 1986 | 1 |
| 380/415 V \sim | 0271 65 | 2016 | 1 |

DRX spreader links

| | | | |
|--------------------|---------|-----|---|
| 3 Links set for TP | 6250 10 | 170 | 1 |
| 4 Links set for FP | 6250 11 | 254 | 1 |

* MRP - Maximum Retail Price Inclusive of all taxes including GST.

BUSBAR TRUNKING SYSTEM

FOR INDUSTRIAL, COMMERCIAL, RESIDENTIAL AND SERVICE SECTOR BUILDINGS

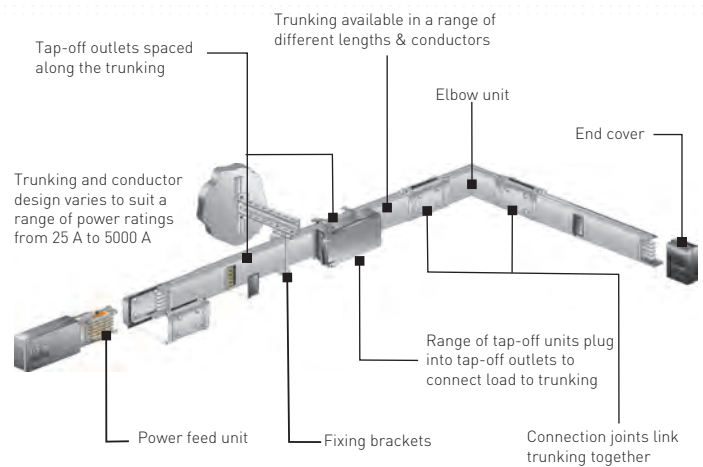

Exclusive features

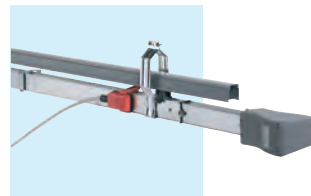

Low Power (25 A, 40 A, 63 A)

- Lighting busway
- 2, 4 & 6 pole
- IP 55 protection
- Tap off units at each 0.5 mt interval
- Copper busbars

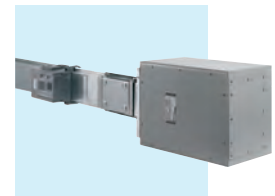

Medium Power (63 A - 1000 A)

- Riser mains application
- IP 40, IP 52, IP 55 protection
- Tap off units at each 1 mt interval
- Aluminium & copper busbars

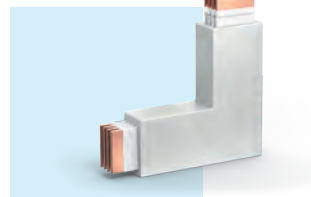

Cast Resin Busbar (630 A - 6300 A)

- Fully insulated with epoxy resin
- IP68 suited for outdoor
- Industrial plants, Petrochemical plants, Chemical plants in areas with risk of flooding.

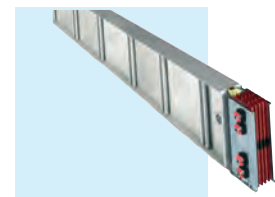

Super Compact (630 A - 6300 A)

- Sandwich type construction
- IP 65 protection
- Tap off boxes at each 1 mt interval
- Aluminium & copper busbars

Bold Cat.Nos are products normally available with Legrand (India) Stockists. **Cat.Nos** that are not bold - delivery within 4 - 8 weeks from the date of order. **Bold packing quantity** is our mandatory packing. Orders to be placed by Legrand (India) Stockist in multiples of the same.

DPX³ MCCB

DPX³ MCCB with Thermal Magnetic Protection Unit

- Range: 16A – 1250A, Ics=100%Icu, Four Optimum Frames
 - Thermal Adjustable – 0.8 to 1In, Magnetic Adjustable** – 5 to 10In
 - Breaking Capacity# – 16kA, 25kA, 36kA, 50kA, 70kA & 100kA
 - Option for In built or add on module for Earth Leakage Protection##
 - Adjustable sensitivity: 0.03 - 0.3 - 1 - 3 A
 - Adjustable tripping: 0 - 0.3 - 1 - 3s
 - Suitable for Isolation
- ** Fixed at 10In for DPX³ 160
 # Refer Catalogue for frame wise data
 ## For DPX³ 160, DPX³ 250 and DPX³ 630 Only

| Category | Type | Rated Current (A) | 3P | | | 4P | | |
|----------|------|-------------------|---------|-------------|------|---------|-------------|------|
| | | | Cat.Nos | MRP*/₹/Unit | Pack | Cat.Nos | MRP*/₹/Unit | Pack |

Thermal Magnetic : O/L & S/C protection

| | | | | | | | | | |
|-------|----------------------|-----------------------|---------|---------|---------|---------|---------|-------|---|
| 16 KA | DPX ³ 160 | 16 | 4200 00 | 6010 | 1 | 4200 10 | 8008 | 1 | |
| | | 25 | 4200 01 | 6010 | 1 | 4200 11 | 8008 | 1 | |
| | | 40 | 4200 02 | 6010 | 1 | 4200 12 | 8008 | 1 | |
| | | 63 | 4200 03 | 6010 | 1 | 4200 13 | 8008 | 1 | |
| | | 80 | 4200 04 | 6010 | 1 | 4200 14 | 8008 | 1 | |
| | | 100 | 4200 05 | 6010 | 1 | 4200 15 | 8008 | 1 | |
| | | 125 | 4200 06 | 6500 | 1 | 4200 16 | 8058 | 1 | |
| | | 160 | 4200 07 | 8300 | 1 | 4200 17 | 10450 | 1 | |
| 25 KA | DPX ³ 160 | 16 | 4200 40 | 6150 | 1 | 4200 50 | 8550 | 1 | |
| | | 25 | 4200 41 | 6150 | 1 | 4200 51 | 8550 | 1 | |
| | | 40 | 4200 42 | 6150 | 1 | 4200 52 | 8550 | 1 | |
| | | 63 | 4200 43 | 6150 | 1 | 4200 53 | 8550 | 1 | |
| | | 80 | 4200 44 | 6150 | 1 | 4200 54 | 8550 | 1 | |
| | | 100 | 4200 45 | 6150 | 1 | 4200 55 | 8550 | 1 | |
| | | 125 | 4200 46 | 8900 | 1 | 4200 56 | 10800 | 1 | |
| | | 160 | 4200 47 | 11900 | 1 | 4200 57 | 13750 | 1 | |
| | | DPX ³ 250 | 200 | 4202 08 | 16858 | 1 | 4202 18 | 20368 | 1 |
| | 250 | | 4202 09 | 19542 | 1 | 4202 19 | 26332 | 1 | |
| 36 KA | DPX ³ 160 | 16 | 4200 80 | 8008 | 1 | 4200 90 | 9990 | 1 | |
| | | 25 | 4200 81 | 8008 | 1 | 4200 91 | 9990 | 1 | |
| | | 40 | 4200 82 | 8008 | 1 | 4200 92 | 9990 | 1 | |
| | | 63 | 4200 83 | 8008 | 1 | 4200 93 | 9990 | 1 | |
| | | 80 | 4200 84 | 8008 | 1 | 4200 94 | 9990 | 1 | |
| | | 100 | 4200 85 | 8008 | 1 | 4200 95 | 9990 | 1 | |
| | | 125 | 4200 86 | 9000 | 1 | 4200 96 | 12250 | 1 | |
| | | 160 | 4200 87 | 12100 | 1 | 4200 97 | 13850 | 1 | |
| | | DPX ³ 250 | 200 | 4202 38 | 21178 | 1 | 4202 48 | 28116 | 1 |
| | 250 | | 4202 39 | 23502 | 1 | 4202 49 | 30110 | 1 | |
| | | DPX ³ 630 | 320 | 4220 01 | 26246 | 1 | 4220 06 | 31298 | 1 |
| | 400 | | 4220 02 | 26246 | 1 | 4220 07 | 31986 | 1 | |
| | 500 | | 4220 03 | 32470 | 1 | 4220 08 | 40550 | 1 | |
| | 630 | | 4220 04 | 32470 | 1 | 4220 09 | 41588 | 1 | |
| | | DPX ³ 1600 | 800 | 4222 52 | 47956 | 1 | 4222 57 | 53952 | 1 |
| 1000 | 4222 53 | | 62594 | 1 | 4222 58 | 79130 | 1 | | |
| 1250 | 4222 54 | | 89440 | 1 | 4222 59 | 95196 | 1 | | |

■ Price available on request.

* MRP - Maximum Retail Price Inclusive of all taxes including GST.

Bold Cat.Nos are products normally available with Legrand (India) Stockists. Cat.Nos that are not bold - delivery within 4 - 8 weeks from the date of order. Bold packing quantity is our mandatory packing. Orders to be placed by Legrand (India) Stockist in multiples of the same.

DPX³ MCCB

DPX³ MCCB with Thermal Magnetic Protection Unit

| Category | Type | Rated Current (A) | 3P | | | 4P | | |
|--|-----------------------|----------------------|---------|-------------|-------|---------|-------------|-------|
| | | | Cat.Nos | MRP*/₹/Unit | Pack | Cat.Nos | MRP*/₹/Unit | Pack |
| Thermal Magnetic : O/L & S/C protection | | | | | | | | |
| 50 KA | DPX ³ 160 | 16 | 4201 20 | 10000 | 1 | 4201 30 | 12600 | 1 |
| | | 25 | 4201 21 | 10000 | 1 | 4201 31 | 12600 | 1 |
| | | 40 | 4201 22 | 10000 | 1 | 4201 32 | 12600 | 1 |
| | | 63 | 4201 23 | 10000 | 1 | 4201 33 | 12600 | 1 |
| | | 80 | 4201 24 | 10000 | 1 | 4201 34 | 12600 | 1 |
| | | 100 | 4201 25 | 10000 | 1 | 4201 35 | 12600 | 1 |
| | | 125 | 4201 26 | 13104 | 1 | 4201 36 | 15100 | 1 |
| | | 160 | 4201 27 | 14750 | 1 | 4201 37 | 17160 | 1 |
| | DPX ³ 250 | 200 | 4202 68 | 23834 | 1 | 4202 78 | 30110 | 1 |
| | | 250 | 4202 69 | 25162 | 1 | 4202 79 | 31318 | 1 |
| | DPX ³ 630 | 320 | 4220 15 | 27704 | 1 | 4220 20 | 33766 | 1 |
| | | 400 | 4220 16 | 28300 | 1 | 4220 21 | 33766 | 1 |
| | | 500 | 4220 17 | 36016 | 1 | 4220 22 | 45484 | 1 |
| | | 630 | 4220 18 | 36016 | 1 | 4220 23 | 46636 | 1 |
| | DPX ³ 1600 | 800 | 4222 64 | 49102 | 1 | 4222 69 | 57640 | 1 |
| | | 1000 | 4222 65 | 76592 | 1 | 4222 70 | 86462 | 1 |
| | | 1250 | 4222 66 | 112520 | 1 | 4222 71 | 115282 | 1 |
| | 70 KA | DPX ³ 250 | 100 | 4206 05 | 20348 | 1 | 4206 15 | 22460 |
| 160 | | | 4206 07 | 25424 | 1 | 4206 17 | 31610 | 1 |
| 200 | | | 4206 08 | 31304 | 1 | 4206 18 | 38518 | 1 |
| 250 | | | 4206 09 | 33264 | 1 | 4206 19 | 40096 | 1 |
| DPX ³ 630 | | 320 | 4220 29 | 33984 | 1 | 4220 34 | 42088 | 1 |
| | | 400 | 4220 30 | 33990 | 1 | 4220 35 | 42088 | 1 |
| | | 500 | 4220 31 | 44326 | 1 | 4220 36 | 57106 | 1 |
| | | 630 | 4220 32 | 46586 | 1 | 4220 37 | 57106 | 1 |
| DPX ³ 1600 | | 800 | 4222 76 | 81224 | 1 | 4222 81 | 94164 | 1 |
| | | 1000 | 4222 77 | 122998 | 1 | 4222 82 | 174152 | 1 |
| | | 1250 | 4222 78 | 126006 | 1 | 4222 83 | 200816 | 1 |

* MRP - Maximum Retail Price Inclusive of all taxes including GST.
 ■ Price available on request.

Bold Cat.Nos are products normally available with Legrand (India) Stockists. Cat.Nos that are not bold - delivery within 4 - 8 weeks from the date of order. Bold packing quantity is our mandatory packing. Orders to be placed by Legrand (India) Stockist in multiples of the same.

DPX³ MCCB

DPX³ MCCB with Thermal Magnetic Protection Unit

| Category | Type | Rated Current (A) | 3P | | | 4P | | | | |
|---|----------------------|----------------------|----------------------|-------------|---------|---------|-------------|---------|-------|---|
| | | | Cat.Nos | MRP*/₹/Unit | Pack | Cat.Nos | MRP*/₹/Unit | Pack | | |
| Thermal Magnetic + Electronic earth leakage module | | | | | | | | | | |
| 16 KA | DPX ³ 160 | 16 | - | - | - | 4200 30 | 26852 | 1 | | |
| | | 25 | - | - | - | 4200 31 | 26852 | 1 | | |
| | | 40 | - | - | - | 4200 32 | 26852 | 1 | | |
| | | 63 | - | - | - | 4200 33 | 26852 | 1 | | |
| | | 80 | - | - | - | 4200 34 | 26852 | 1 | | |
| | | 100 | - | - | - | 4200 35 | 26852 | 1 | | |
| | | 125 | - | - | - | 4200 36 | 28326 | 1 | | |
| | | 160 | - | - | - | 4200 37 | 34556 | 1 | | |
| 25 KA | DPX ³ 160 | 16 | - | - | - | 4200 70 | 29166 | 1 | | |
| | | 25 | - | - | - | 4200 71 | 29166 | 1 | | |
| | | 40 | - | - | - | 4200 72 | 29166 | 1 | | |
| | | 63 | - | - | - | 4200 73 | 29166 | 1 | | |
| | | 80 | - | - | - | 4200 74 | 29166 | 1 | | |
| | | 100 | - | - | - | 4200 75 | 29166 | 1 | | |
| | | 125 | - | - | - | 4200 76 | 29176 | 1 | | |
| | | 160 | - | - | - | 4200 77 | 34444 | 1 | | |
| | DPX ³ 250 | 100 | - | - | - | 4202 25 | 37090 | 1 | | |
| | | 160 | - | - | - | 4202 27 | 38988 | 1 | | |
| | | 200 | - | - | - | 4202 28 | 40496 | 1 | | |
| | | 250 | - | - | - | 4202 29 | 43306 | 1 | | |
| | | 36 KA | DPX ³ 160 | 16 | - | - | - | 4201 10 | 35138 | 1 |
| | | | | 25 | - | - | - | 4201 11 | 35138 | 1 |
| 40 | - | | | - | - | 4201 12 | 35138 | 1 | | |
| 63 | - | | | - | - | 4201 13 | 35138 | 1 | | |
| 80 | - | | | - | - | 4201 14 | 35138 | 1 | | |
| 100 | - | | | - | - | 4201 15 | 35138 | 1 | | |
| 125 | - | | | - | - | 4201 16 | 35328 | 1 | | |
| 160 | - | | | - | - | 4201 17 | 42020 | 1 | | |
| DPX ³ 250 | 100 | - | - | - | 4202 55 | 36874 | 1 | | | |
| | 160 | - | - | - | 4202 57 | 42948 | 1 | | | |
| | 200 | - | - | - | 4202 58 | 45046 | 1 | | | |
| | 250 | - | - | - | 4202 59 | 48170 | 1 | | | |
| | 50 KA | DPX ³ 160 | 16 | - | - | - | 4201 50 | 39560 | 1 | |
| | | | 25 | - | - | - | 4201 51 | 39560 | 1 | |
| 40 | | | - | - | - | 4201 52 | 39560 | 1 | | |
| 63 | | | - | - | - | 4201 53 | 39560 | 1 | | |
| 80 | | | - | - | - | 4201 54 | 39560 | 1 | | |
| 100 | | | - | - | - | 4201 55 | 39560 | 1 | | |
| 125 | | | - | - | - | 4201 56 | 42150 | 1 | | |
| 160 | | | - | - | - | 4201 57 | 45112 | 1 | | |
| DPX ³ 250 | | 100 | - | - | - | 4202 85 | 43020 | 1 | | |
| | | 160 | - | - | - | 4202 87 | 49796 | 1 | | |
| | | 200 | - | - | - | 4202 88 | 52466 | 1 | | |
| | | 250 | - | - | - | 4202 89 | 55744 | 1 | | |

■ Price available on request.

* MRP - Maximum Retail Price Inclusive of all taxes including GST.

Bold Cat.Nos are products normally available with Legrand (India) Stockists. Cat.Nos that are not bold - delivery within 4 - 8 weeks from the date of order. Bold packing quantity is our mandatory packing. Orders to be placed by Legrand (India) Stockist in multiples of the same.

DPX³ MCCB

DPX³ MCCB with Electronic S2* (LSI)* Protection Unit

- Range: 40A – 1600A, Ics=100%Icu, Three Optimum Frames
- Protection against overloads:
 - Ir adjustable from 0.4 to 1 x In
 - tr adjustable from 3 to 30s#
- Protection against short circuits:
 - I_{sd} adjustable from 1.5 to 10 x Ir
 - t_{sd} adjustable from 0 to 0.5s
- Inbuilt Instantaneous Protection:
 - Ii# – Fixed
- Option for In built or add on module for Earth Leakage Protection##
 - Adjustable sensitivity: 0.03 - 0.3 - 1 - 3 A
 - Adjustable tripping: 0 - 0.3 - 1 - 3s
- Breaking Capacity# – 25kA, 36kA, 50kA, 70kA & 100kA
- In built Display for Current Metering with accuracy of class 1
- Internal Battery with battery measure function
- Communication Ready via COMM Port
- Logical Selectivity Ready (Zone Selective Interlocking)
- Dynamic Selectivity as per Selectivity Charts
- In Built USB Port for Software Diagnosis
- Suitable for Isolation

| Category | Type | Rated Current (A) | 3P | | | 4P | | |
|----------|------|-------------------|---------|-------------|------|---------|-------------|------|
| | | | Cat.Nos | MRP*/₹/Unit | Pack | Cat.Nos | MRP*/₹/Unit | Pack |

Electronic S2

| | | | | | | | | |
|-----------------------|-----------------------|---------|---------|--------|---------|---------|--------|---|
| 25 KA | DPX ³ 250 | 40 | 4203 02 | 16712 | 1 | 4203 12 | 21942 | 1 |
| | | 100 | 4203 05 | 16712 | 1 | 4203 15 | 21942 | 1 |
| | | 160 | 4203 07 | 21652 | 1 | 4203 17 | 25896 | 1 |
| | | 250 | 4203 09 | 28238 | 1 | 4203 19 | 36432 | 1 |
| 36 KA | DPX ³ 250 | 40 | 4203 32 | 17788 | 1 | 4203 42 | 21924 | 1 |
| | | 100 | 4203 35 | 17788 | 1 | 4203 45 | 21924 | 1 |
| | | 160 | 4203 37 | 22290 | 1 | 4203 47 | 29742 | 1 |
| | | 250 | 4203 39 | 29862 | 1 | 4203 49 | 40854 | 1 |
| | DPX ³ 630 | 320 | 4220 57 | 31950 | 1 | 4220 62 | 39882 | 1 |
| | | 400 | 4220 58 | 31950 | 1 | 4220 63 | 39048 | 1 |
| | | 500 | 4220 59 | 35752 | 1 | 4220 64 | 47954 | 1 |
| | | 630 | 4220 60 | 36500 | 1 | 4220 65 | 48964 | 1 |
| DPX ³ 1600 | 800 | 4223 00 | 59224 | 1 | 4223 06 | 73134 | 1 | |
| | 1000 | 4223 01 | 90680 | 1 | 4223 07 | 133808 | 1 | |
| | 1250 | 4223 02 | 109268 | 1 | 4223 08 | 162756 | 1 | |
| | 1600 | 4223 03 | 135228 | 1 | 4223 09 | 181638 | 1 | |
| 50 KA | DPX ³ 250 | 40 | 4203 62 | 21596 | 1 | 4203 72 | 28780 | 1 |
| | | 100 | 4203 65 | 21596 | 1 | 4203 75 | 28312 | 1 |
| | | 160 | 4203 67 | 26076 | 1 | 4203 77 | 31136 | 1 |
| | | 250 | 4203 69 | 34796 | 1 | 4203 79 | 42116 | 1 |
| | DPX ³ 630 | 320 | 4220 67 | 35274 | 1 | 4220 72 | 44986 | 1 |
| | | 400 | 4220 68 | 35274 | 1 | 4220 73 | 44986 | 1 |
| | | 500 | 4220 69 | 41214 | 1 | 4220 74 | 51518 | 1 |
| | | 630 | 4220 70 | 41214 | 1 | 4220 75 | 51518 | 1 |
| | DPX ³ 1600 | 800 | 4223 12 | 67840 | 1 | 4223 18 | 91476 | 1 |
| | | 1000 | 4223 13 | 94358 | 1 | 4223 19 | 131508 | 1 |
| | | 1250 | 4223 14 | 114498 | 1 | 4223 20 | 166898 | 1 |
| | | 1600 | 4223 15 | 160358 | 1 | 4223 21 | 203880 | 1 |

* MRP - Maximum Retail Price Inclusive of all taxes including GST.
 ■ Price available on request.

Bold Cat.Nos are products normally available with Legrand (India) Stockists. Cat.Nos that are not bold - delivery within 4 - 8 weeks from the date of order. Bold packing quantity is our mandatory packing. Orders to be placed by Legrand (India) Stockist in multiples of the same.

DRX MCCB

DPX³ MCCB with Electronic S2* (LSI)* Protection Unit

| Category | Type | Rated Current (A) | 3P | | | 4P | | |
|----------|------|-------------------|---------|-------------|------|---------|-------------|------|
| | | | Cat.Nos | MRP*/₹/Unit | Pack | Cat.Nos | MRP*/₹/Unit | Pack |

Electronic S2

| | | | | | | | | |
|-------|-----------------------|------|---------|--------|---|---------|--------|---|
| 70 KA | DPX ³ 250 | 40 | 4206 35 | 27314 | 1 | 4206 45 | 36134 | 1 |
| | | 100 | 4206 37 | 27590 | 1 | 4206 47 | 36134 | 1 |
| | | 160 | 4206 38 | 36130 | 1 | 4206 48 | 41508 | 1 |
| | | 250 | 4206 39 | 41252 | 1 | 4206 49 | 53240 | 1 |
| | DPX ³ 630 | 320 | 4220 77 | 46438 | 1 | 4220 82 | 59944 | 1 |
| | | 400 | 4220 78 | 46438 | 1 | 4220 83 | 59944 | 1 |
| | | 500 | 4220 79 | 52838 | 1 | 4220 84 | 67384 | 1 |
| | | 630 | 4220 80 | 52838 | 1 | 4220 85 | 67384 | 1 |
| | DPX ³ 1600 | 800 | 4223 24 | 91912 | 1 | 4223 30 | 116316 | 1 |
| | | 1000 | 4223 25 | 128800 | 1 | 4223 31 | 183820 | 1 |
| | | 1250 | 4223 26 | 154244 | 1 | 4223 32 | 214454 | 1 |
| | | 1600 | 4223 27 | 207346 | 1 | 4223 33 | 265504 | 1 |

Electronic S2 + Electronic earth leakage module

| | | | | | | | | |
|-------|----------------------|-----|---|---|---|---------|--------|---|
| 25 kA | DPX ³ 250 | 40 | - | - | - | 4203 22 | 49886 | 1 |
| | | 100 | - | - | - | 4203 25 | 49886 | 1 |
| | | 160 | - | - | - | 4203 27 | 53514 | 1 |
| | | 250 | - | - | - | 4203 29 | 62932 | 1 |
| 36 kA | DPX ³ 250 | 40 | - | - | - | 4203 52 | 51018 | 1 |
| | | 100 | - | - | - | 4203 55 | 51018 | 1 |
| | | 160 | - | - | - | 4203 57 | 56146 | 1 |
| | | 250 | - | - | - | 4203 59 | 65624 | 1 |
| 50 kA | DPX ³ 250 | 40 | - | - | - | 4203 82 | 53752 | 1 |
| | | 100 | - | - | - | 4203 85 | 53752 | 1 |
| | | 160 | - | - | - | 4203 87 | 58124 | 1 |
| | | 250 | - | - | - | 4203 89 | 67698 | 1 |
| 70 kA | DPX ³ 250 | 40 | - | - | - | 4206 55 | 73306 | 1 |
| | | 100 | - | - | - | 4206 57 | 73306 | 1 |
| | | 160 | - | - | - | 4206 58 | 82838 | 1 |
| | | 250 | - | - | - | 4206 59 | 113474 | 1 |

■ Price available on request.

* MRP - Maximum Retail Price Inclusive of all taxes including GST.

Bold Cat.Nos are products normally available with Legrand (India) Stockists. Cat.Nos that are not bold - delivery within 4 - 8 weeks from the date of order. Bold packing quantity is our mandatory packing. Orders to be placed by Legrand (India) Stockist in multiples of the same.

DPX³ MCCB

DPX³ MCCB with Electronic Sg (LSIg) Protection Unit

- Range: 40A – 1600A, Ics=100%Icu, Three Optimum Frames
- Protection against Overloads:
 - Ir adjustable from 0.4 to 1 x In
 - tr adjustable from 3 to 30s#
- Protection against Short Circuits:
 - Isd adjustable from 1.5 to 10 x Ir
 - tsd adjustable from 0 to 0.5s
- Inbuilt Instantaneous Protection:
 - li# – Fixed
- Protection against Ground Fault:
 - Ig adjustable from 0.2 to 1 In & OFF
 - tg adjustable from 0.1 to 1s
- Breaking Capacity#– 25kA, 36kA, 50kA, 70kA & 100kA
- In built Display for Current Metering with high accuracy of class 1
- Internal Battery with battery measure function
- Communication Ready via COMM Port
- Logical Selectivity Ready (Zone Selective Interlocking)
- Dynamic Selectivity as per Selectivity Charts
- In Built USB Port for Software Diagnosis
- Switchable Thermal Memory
- Suitable for Isolation

| Category | Type | Rated Current (A) | 3P | | | 4P | | |
|----------|------|-------------------|---------|-------------|------|---------|-------------|------|
| | | | Cat.Nos | MRP*/₹/Unit | Pack | Cat.Nos | MRP*/₹/Unit | Pack |

Electronic Sg

| | | | | | | | | |
|-----------------------|-----------------------|---------|---------|--------|---------|---------|--------|---|
| 25 KA | DPX ³ 250 | 40 | 4205 02 | 36346 | 1 | 4205 12 | 40682 | 1 |
| | | 100 | 4205 05 | 36346 | 1 | 4205 15 | 40682 | 1 |
| | | 160 | 4205 07 | 40440 | 1 | 4205 17 | 44836 | 1 |
| | | 250 | 4205 09 | 44706 | 1 | 4205 19 | 52310 | 1 |
| 36 KA | DPX ³ 250 | 40 | 4205 22 | 37176 | 1 | 4205 32 | 41880 | 1 |
| | | 100 | 4205 25 | 37176 | 1 | 4205 35 | 41880 | 1 |
| | | 160 | 4205 27 | 41050 | 1 | 4205 37 | 43540 | 1 |
| | | 250 | 4205 29 | 42158 | 1 | 4205 39 | 44650 | 1 |
| | DPX ³ 630 | 320 | 4221 37 | 46028 | 1 | 4221 42 | 49900 | 1 |
| | | 400 | 4221 38 | 46028 | 1 | 4221 43 | 49900 | 1 |
| | | 500 | 4221 39 | 50302 | 1 | 4221 44 | 60532 | 1 |
| | | 630 | 4221 40 | 50302 | 1 | 4221 45 | 60532 | 1 |
| DPX ³ 1600 | 800 | 4223 96 | 87520 | 1 | 4224 02 | 105504 | 1 | |
| | 1000 | 4223 97 | 116296 | 1 | 4224 03 | 153022 | 1 | |
| | 1250 | 4223 98 | 130682 | 1 | 4224 04 | 182238 | 1 | |
| | 1600 | 4223 99 | 142672 | 1 | 4224 05 | 215806 | 1 | |
| 50 KA | DPX ³ 250 | 40 | 4205 42 | 38560 | 1 | 4205 52 | 42618 | 1 |
| | | 100 | 4205 45 | 38560 | 1 | 4205 55 | 42618 | 1 |
| | | 160 | 4205 47 | 42434 | 1 | 4205 57 | 44836 | 1 |
| | | 250 | 4205 49 | 43540 | 1 | 4205 59 | 52530 | 1 |
| | DPX ³ 630 | 320 | 4221 47 | 47250 | 1 | 4221 52 | 56240 | 1 |
| | | 400 | 4221 48 | 47444 | 1 | 4221 53 | 56240 | 1 |
| | | 500 | 4221 49 | 53832 | 1 | 4221 54 | 67890 | 1 |
| | | 630 | 4221 50 | 53832 | 1 | 4221 55 | 67890 | 1 |
| | DPX ³ 1600 | 800 | 4224 08 | 98398 | 1 | 4224 14 | 109822 | 1 |
| | | 1000 | 4224 09 | 132138 | 1 | 4224 15 | 167490 | 1 |
| | | 1250 | 4224 10 | 135180 | 1 | 4224 16 | 188710 | 1 |
| | | 1600 | 4224 11 | 144232 | 1 | 4224 17 | 221742 | 1 |

* MRP - Maximum Retail Price Inclusive of all taxes including GST.
 ■ Price available on request.

Bold Cat.Nos are products normally available with Legrand (India) Stockists.
 Cat.Nos that are not bold - delivery within 4 - 8 weeks from the date of order.
 Bold packing quantity is our mandatory packing. Orders to be placed by Legrand (India) Stockist in multiples of the same.

DPX³ MCCB

DPX³ MCCB with Electronic Sg (LSIg) Protection Unit

| Category | Type | Rated Current (A) | 3P | | | 4P | | |
|----------|-----------------------|-------------------|---------|-------------|------|---------|-------------|------|
| | | | Cat.Nos | MRP*/₹/Unit | Pack | Cat.Nos | MRP*/₹/Unit | Pack |
| 70 kA | DPX ³ 250 | 40 | 4206 92 | 41262 | 1 | 4207 02 | 46770 | 1 |
| | | 100 | 4206 95 | 41262 | 1 | 4207 05 | 46770 | 1 |
| | | 160 | 4206 97 | 48240 | 1 | 4207 07 | 52098 | 1 |
| | | 250 | 4206 99 | 49404 | 1 | 4207 09 | 54826 | 1 |
| | DPX ³ 630 | 320 | 4221 57 | 57522 | 1 | 4221 62 | 70970 | 1 |
| | | 400 | 4221 58 | 57522 | 1 | 4221 63 | 70970 | 1 |
| | | 500 | 4221 59 | 66228 | 1 | 4221 64 | 90124 | 1 |
| | | 630 | 4221 60 | 66228 | 1 | 4221 65 | 90124 | 1 |
| | DPX ³ 1600 | 800 | 4224 20 | 100136 | 1 | 4224 26 | 120764 | 1 |
| | | 1000 | 4224 21 | 139970 | 1 | 4224 27 | 216540 | 1 |
| | | 1250 | 4224 22 | 185708 | 1 | 4224 28 | 250676 | 1 |
| | | 1600 | 4224 23 | 250762 | 1 | 4224 29 | 295514 | 1 |

DPX³ MCCB

DPX³ MCCB with Electronic S2* (LSI)* & Energy Metering Protection Unit

- Range: 40A – 1600A, Ics=100%Icu, Three Optimum Frames
- Protection against overloads:
 - Ir adjustable from 0.4 to 1 x In
 - tr adjustable from 3 to 30s#
- Protection against short circuits:
 - Isd adjustable from 1.5 to 10 x Ir
 - tsd adjustable from 0 to 0.5s
- Inbuilt Instantaneous Protection:
 - li# – Fixed
- Option for In built or add on module for Earth Leakage Protection##
 - Adjustable sensitivity: 0.03 - 0.3 - 1 - 3 A
 - Adjustable tripping: 0 - 0.3 - 1 - 3s
- Breaking Capacity# – 25kA, 36kA, 50kA, 70kA & 100kA
- Integrated energy metering with accuracy class 2
- Measure for currents, voltage, frequency, power, energy and harmonics
- Internal Battery with battery measure function
- Communication Ready via COMM Port
- Logical Selectivity Ready (Zone Selective Interlocking)
- Dynamic Selectivity as per Selectivity Charts
- In Built USB Port for Software Diagnosis
- Suitable for Isolation

| Category | Type | Rated Current (A) | 3P | | | 4P | | |
|----------|----------------------|-------------------|---------|-------------|------|---------|-------------|------|
| | | | Cat.Nos | MRP*/₹/Unit | Pack | Cat.Nos | MRP*/₹/Unit | Pack |
| 25 KA | DPX ³ 250 | 40 | 4204 02 | ■ | 1 | 4204 12 | ■ | 1 |
| | | 100 | 4204 05 | ■ | 1 | 4204 15 | ■ | 1 |
| | | 160 | 4204 07 | ■ | 1 | 4204 17 | ■ | 1 |
| | | 250 | 4204 09 | ■ | 1 | 4204 19 | ■ | 1 |
| 36 KA | DPX ³ 250 | 40 | 4204 32 | ■ | 1 | 4204 42 | ■ | 1 |
| | | 100 | 4204 35 | ■ | 1 | 4204 45 | ■ | 1 |
| | | 160 | 4204 37 | ■ | 1 | 4204 47 | ■ | 1 |
| | | 250 | 4204 39 | ■ | 1 | 4204 49 | ■ | 1 |
| | DPX ³ 630 | 320 | 4220 97 | ■ | 1 | 4221 02 | ■ | 1 |
| | | 400 | 4220 98 | ■ | 1 | 4221 03 | ■ | 1 |
| | | 500 | 4220 99 | ■ | 1 | 4221 04 | ■ | 1 |
| | | 630 | 4221 00 | ■ | 1 | 4221 05 | ■ | 1 |

■ Price available on request.

* MRP - Maximum Retail Price Inclusive of all taxes including GST.

Bold Cat.Nos are products normally available with Legrand (India) Stockists. Cat.Nos that are not bold - delivery within 4 - 8 weeks from the date of order. Bold packing quantity is our mandatory packing. Orders to be placed by Legrand (India) Stockist in multiples of the same.

DPX³ MCCB
DPX³ MCCB with Electronic S2[#] (LSI)[#] & Energy Metering Protection Unit

| Category | Type | Rated Current (A) | 3P | | | 4P | | |
|----------|------|-------------------|---------|-------------|------|---------|-------------|------|
| | | | Cat.Nos | MRP*/₹/Unit | Pack | Cat.Nos | MRP*/₹/Unit | Pack |

Electronic S2 + Energy metering

| | | | | | | | | |
|-----------------------|-----------------------|---------|---------|---|---------|---------|---|---|
| 36 KA | DPX ³ 1600 | 800 | 4223 48 | ■ | 1 | 4223 54 | ■ | 1 |
| | | 1000 | 4223 49 | ■ | 1 | 4223 55 | ■ | 1 |
| | | 1250 | 4223 50 | ■ | 1 | 4223 56 | ■ | 1 |
| | | 1600 | 4223 51 | ■ | 1 | 4223 57 | ■ | 1 |
| 50 KA | DPX ³ 250 | 40 | 4204 62 | ■ | 1 | 4204 72 | ■ | 1 |
| | | 100 | 4204 65 | ■ | 1 | 4204 75 | ■ | 1 |
| | | 160 | 4204 67 | ■ | 1 | 4204 77 | ■ | 1 |
| | | 250 | 4204 69 | ■ | 1 | 4204 79 | ■ | 1 |
| | DPX ³ 630 | 320 | 4221 07 | ■ | 1 | 4221 12 | ■ | 1 |
| | | 400 | 4221 08 | ■ | 1 | 4221 13 | ■ | 1 |
| | | 500 | 4221 09 | ■ | 1 | 4221 14 | ■ | 1 |
| | | 630 | 4221 10 | ■ | 1 | 4221 15 | ■ | 1 |
| DPX ³ 1600 | 800 | 4223 60 | ■ | 1 | 4223 66 | ■ | 1 | |
| | 1000 | 4223 61 | ■ | 1 | 4223 67 | ■ | 1 | |
| | 1250 | 4223 62 | ■ | 1 | 4223 68 | ■ | 1 | |
| | 1600 | 4223 63 | ■ | 1 | 4223 69 | ■ | 1 | |
| 70 KA | DPX ³ 250 | 40 | 4206 65 | ■ | 1 | 4206 75 | ■ | 1 |
| | | 100 | 4206 67 | ■ | 1 | 4206 77 | ■ | 1 |
| | | 160 | 4206 68 | ■ | 1 | 4206 78 | ■ | 1 |
| | | 250 | 4206 69 | ■ | 1 | 4206 79 | ■ | 1 |
| | DPX ³ 630 | 320 | 4221 17 | ■ | 1 | 4221 22 | ■ | 1 |
| | | 400 | 4221 18 | ■ | 1 | 4221 23 | ■ | 1 |
| | | 500 | 4221 19 | ■ | 1 | 4221 24 | ■ | 1 |
| | | 630 | 4221 20 | ■ | 1 | 4221 25 | ■ | 1 |
| DPX ³ 1600 | 800 | 4223 72 | ■ | 1 | 4223 78 | ■ | 1 | |
| | 1000 | 4223 73 | ■ | 1 | 4223 79 | ■ | 1 | |
| | 1250 | 4223 74 | ■ | 1 | 4223 80 | ■ | 1 | |
| | 1600 | 4223 75 | ■ | 1 | 4223 81 | ■ | 1 | |

Electronic S2 + Energy Metering + Electronic earth leakage module

| | | | | | | | | |
|-------|----------------------|-----|---|---|---|---------|---|---|
| 25 KA | DPX ³ 250 | 40 | - | - | - | 4204 22 | ■ | 1 |
| | | 100 | - | - | - | 4204 25 | ■ | 1 |
| | | 160 | - | - | - | 4204 27 | ■ | 1 |
| | | 250 | - | - | - | 4204 29 | ■ | 1 |
| 36 KA | DPX ³ 250 | 40 | - | - | - | 4204 52 | ■ | 1 |
| | | 100 | - | - | - | 4204 55 | ■ | 1 |
| | | 160 | - | - | - | 4204 57 | ■ | 1 |
| | | 250 | - | - | - | 4204 59 | ■ | 1 |
| 50 KA | DPX ³ 250 | 40 | - | - | - | 4204 82 | ■ | 1 |
| | | 100 | - | - | - | 4204 85 | ■ | 1 |
| | | 160 | - | - | - | 4204 87 | ■ | 1 |
| | | 250 | - | - | - | 4204 89 | ■ | 1 |
| 70 KA | DPX ³ 250 | 40 | - | - | - | 4206 85 | ■ | 1 |
| | | 100 | - | - | - | 4206 87 | ■ | 1 |
| | | 160 | - | - | - | 4206 88 | ■ | 1 |
| | | 250 | - | - | - | 4206 89 | ■ | 1 |

* MRP - Maximum Retail Price Inclusive of all taxes including GST.
 ■ Price available on request.

Bold Cat.Nos are products normally available with Legrand (India) Stockists. Cat.Nos that are not bold - delivery within 4 - 8 weeks from the date of order. Bold packing quantity is our mandatory packing. Orders to be placed by Legrand (India) Stockist in multiples of the same.

DPX³ MCCB

DPX³ MCCB with Electronic Sg (LSIg) & Energy Metering Protection Unit

- Range: 250A – 1600A, Ics=100%Icu, Two Optimum Frames
- Protection against Overloads:
 - Ir adjustable from 0.4 to 1 x In
 - tr adjustable from 3 to 30s
- Protection against Short Circuits:
 - I_{sd} adjustable from 1.5 to 10 x Ir
 - t_{sd} adjustable from 0 to 0.5s
- Inbuilt Instantaneous Protection:
 - li – Fixed
- Protection against Ground Fault:
 - I_g adjustable from 0.2 to 1 In & OFF
 - t_g adjustable from 0.1 to 1s
- Breaking Capacity – 36kA, 50kA, 70kA & 100kA
- Integrated energy metering with accuracy class 2
- Measure for currents, voltage, frequency, power, energy and harmonics
- Internal Battery with battery measure function
- Communication Ready via COMM Port
- Logical Selectivity Ready (Zone Selective Interlocking)
- Dynamic Selectivity as per Selectivity Charts
- In Built USB Port for Software Diagnosis
- Switchable Thermal Memory
- Suitable for Isolation

| Category | Type | Rated Current (A) | 3P | | | 4P | | |
|----------|------|-------------------|---------|-------------|------|---------|-------------|------|
| | | | Cat.Nos | MRP*/₹/Unit | Pack | Cat.Nos | MRP*/₹/Unit | Pack |

Electronic Sg + Energy metering

| | | | | | | | | |
|-------|-----------------------|------|---------|---|---|---------|---|---|
| 36 KA | DPX ³ 630 | 320 | 4221 77 | ■ | 1 | 4221 82 | ■ | 1 |
| | | 400 | 4221 78 | ■ | 1 | 4221 83 | ■ | 1 |
| | | 500 | 4221 79 | ■ | 1 | 4221 84 | ■ | 1 |
| | | 630 | 4221 80 | ■ | 1 | 4221 85 | ■ | 1 |
| | DPX ³ 1600 | 800 | 4224 44 | ■ | 1 | 4224 50 | ■ | 1 |
| | | 1000 | 4224 45 | ■ | 1 | 4224 51 | ■ | 1 |
| | | 1250 | 4224 46 | ■ | 1 | 4224 52 | ■ | 1 |
| | | 1600 | 4224 47 | ■ | 1 | 4224 53 | ■ | 1 |
| 50 KA | DPX ³ 630 | 320 | 4221 87 | ■ | 1 | 4221 92 | ■ | 1 |
| | | 400 | 4221 88 | ■ | 1 | 4221 93 | ■ | 1 |
| | | 500 | 4221 89 | ■ | 1 | 4221 94 | ■ | 1 |
| | | 630 | 4221 90 | ■ | 1 | 4221 95 | ■ | 1 |
| | DPX ³ 1600 | 800 | 4224 56 | ■ | 1 | 4224 62 | ■ | 1 |
| | | 1000 | 4224 57 | ■ | 1 | 4224 63 | ■ | 1 |
| | | 1250 | 4224 58 | ■ | 1 | 4224 64 | ■ | 1 |
| | | 1600 | 4224 59 | ■ | 1 | 4224 65 | ■ | 1 |
| 70 KA | DPX ³ 630 | 320 | 4221 97 | ■ | 1 | 4222 02 | ■ | 1 |
| | | 400 | 4221 98 | ■ | 1 | 4222 03 | ■ | 1 |
| | | 500 | 4221 99 | ■ | 1 | 4222 04 | ■ | 1 |
| | | 630 | 4222 00 | ■ | 1 | 4222 05 | ■ | 1 |
| | DPX ³ 1600 | 800 | 4224 68 | ■ | 1 | 4224 74 | ■ | 1 |
| | | 1000 | 4224 69 | ■ | 1 | 4224 75 | ■ | 1 |
| | | 1250 | 4224 70 | ■ | 1 | 4224 76 | ■ | 1 |
| | | 1600 | 4224 71 | ■ | 1 | 4224 77 | ■ | 1 |

Switch disconnecter

| | | | | | | | | |
|--|----------------------|-----|---------|---|---|---------|---|---|
| | DPX ³ 160 | 160 | 4201 98 | ■ | 1 | 4201 99 | ■ | 1 |
| | | 250 | 4202 99 | ■ | 1 | 4203 00 | ■ | 1 |
| | DPX ³ 630 | 400 | 4222 16 | ■ | 1 | 4222 18 | ■ | 1 |
| | | 630 | 4222 17 | ■ | 1 | 4222 19 | ■ | 1 |

■ Price available on request.

* MRP - Maximum Retail Price Inclusive of all taxes including GST.

Bold Cat.Nos are products normally available with Legrand (India) Stockists. Cat.Nos that are not bold - delivery within 4 - 8 weeks from the date of order. Bold packing quantity is our mandatory packing. Orders to be placed by Legrand (India) Stockist in multiples of the same.

DPX³ MCCB

| Category | Type | Rated Current (A) | 3P | | | 4P | | |
|----------|------|-------------------|---------|-------------|------|---------|-------------|------|
| | | | Cat.Nos | MRP*/₹/Unit | Pack | Cat.Nos | MRP*/₹/Unit | Pack |

Only magnetic

| | | | | | | | | |
|-------|----------------------|-----|---------|-------|---|---|---|---|
| 16 KA | DPX ³ 160 | 16 | 4207 10 | 11918 | 1 | - | - | - |
| | | 25 | 4207 11 | 11918 | 1 | - | - | - |
| | | 50 | 4207 12 | 11918 | 1 | - | - | - |
| | | 63 | 4207 13 | 11918 | 1 | - | - | - |
| 25 KA | DPX ³ 160 | 16 | 4207 14 | 13244 | 1 | - | - | - |
| | | 25 | 4207 15 | 13244 | 1 | - | - | - |
| | | 50 | 4207 16 | 13244 | 1 | - | - | - |
| | | 63 | 4207 17 | 13244 | 1 | - | - | - |
| 36 KA | DPX ³ 250 | 100 | 4207 18 | 23130 | 1 | - | - | - |
| | | 160 | 4207 19 | 23130 | 1 | - | - | - |
| | | 200 | 4207 20 | 24456 | 1 | - | - | - |
| | | 250 | 4207 21 | 25778 | 1 | - | - | - |
| 70 KA | DPX ³ 250 | 100 | 4207 22 | ■ | 1 | - | - | - |
| | | 160 | 4207 23 | ■ | 1 | - | - | - |
| | | 200 | 4207 24 | ■ | 1 | - | - | - |
| | | 250 | 4207 25 | ■ | 1 | - | - | - |

Accessories

| Type | Rotary handle | | | | Shunt release | | | | | | | | | | | |
|--|---------------|------|------------|------|---------------|------|---------|------|---------|------|---------|------|---------|------|---------|------|
| | Direct | | Vary depth | | 12 V | | 24 V | | 48 V | | 110 V | | 230 V | | 400 V | |
| | Cat.No | MRP | Cat.No | MRP | Cat.No | MRP | Cat.No | MRP | Cat.No | MRP | Cat.No | MRP | Cat.No | MRP | Cat.No | MRP |
| DPX ³ 160 DPX ³ 250 | 4201 60 | 1074 | 4201 61 | 1556 | 4210 12 | 2026 | 4210 13 | 2026 | 4210 14 | 2026 | 4210 15 | 2026 | 4210 16 | 2026 | 4210 17 | 2026 |
| DPX ³ 630 | 4201 62 | 1718 | 4201 63 | 2954 | - | - | 4222 39 | 2062 | 4222 40 | 2062 | 4222 41 | 2062 | 4222 42 | 2062 | 4222 43 | 2062 |
| DPX ³ 1600 | 0262 61 | 3570 | 0262 83 | 4996 | - | - | - | - | - | - | - | - | - | - | - | - |

| Type | U/V release | | | | | | | | | | | | | |
|---|-------------|------|---------|------|---------|------|---------|------|---------|------|---------|------|---------|------|
| | 12 V | | 24 V | | 48 V | | 110 V | | 230 V | | 400 V | | 480 V | |
| | Cat.No | MRP | Cat.No | MRP | Cat.No | MRP | Cat.No | MRP | Cat.No | MRP | Cat.No | MRP | Cat.No | MRP |
| DPX ³ 160 DPX ³ 250 | 4210 18 | 2302 | 4210 19 | 2302 | 4210 20 | 2302 | 4210 21 | 2280 | 4210 22 | 2280 | 4210 24 | 2280 | 4210 25 | 2280 |
| DPX ³ 630 DPX ³ 1600 | - | - | 4222 45 | 2436 | 4222 46 | 2436 | 4222 47 | 2414 | 4222 48 | 2414 | 4222 49 | 2414 | - | - |

| Type | Rated Current (A) | Spreaders** | | | | Motor Operator | | | | | | | | | |
|-----------------------|-------------------|---------------|------|---------------|------|----------------|-------|---------|-------|---------|-------|---------|-------|---------|-------|
| | | 3P (Set of 3) | | 4P (Set of 4) | | 24-230V Side | | 24V | | 48V | | 110V | | 230V | |
| | | Cat.No | MRP | Cat.No | MRP | Cat.No | MRP | Cat.No | MRP | Cat.No | MRP | Cat.No | MRP | Cat.No | MRP |
| DPX ³ 160 | | 6250 02 | 400 | 6250 06 | 600 | 4210 60 | 28576 | 4210 61 | 25670 | 4210 61 | 25670 | 4210 61 | 25670 | 4210 61 | 25670 |
| DPX ³ 250 | | 6250 14 | 608 | 6250 18 | 808 | - | - | - | - | - | - | - | - | - | - |
| DPX ³ 630 | | 6250 04 | 1312 | 6250 08 | 1782 | - | - | 0261 40 | 40172 | 0261 41 | 40172 | - | - | 0261 44 | 40172 |
| DPX ³ 1600 | Upto 1250 A | 4226 24 | ■ | 4226 25 | ■ | - | - | 0261 24 | 78930 | 0261 25 | 89416 | 0261 26 | ■ | 0261 23 | 49540 |
| | Above 1600 A | 0262 73 | ■ | 0262 74 | ■ | - | - | 0261 19 | 79760 | 0261 28 | 68756 | 0261 29 | ■ | 0261 27 | 50014 |

* MRP - Maximum Retail Price Inclusive of all taxes including GST.
 ■ Price available on request.

Bold Cat.Nos are products normally available with Legrand (India) Stockists.
 Cat.Nos that are not bold - delivery within 4 - 8 weeks from the date of order.
 Bold packing quantity is our mandatory packing. Orders to be placed by Legrand (India) Stockist in multiples of the same.

DPX³ 160 equipment and mounting accessories



4210 40

| Cat.Nos | Description | MRP* ₹ / Unit | Pack |
|---------|-------------|---------------------|------|
|---------|-------------|---------------------|------|

Equipment for plug-in version

| | | | |
|---------|--|---|---|
| 4210 40 | For DPX ³ 160 - 3P | ■ | 1 |
| 4210 41 | For DPX ³ 160 - 4P | ■ | 1 |
| 4210 44 | Set of connectors for auxiliary contacts | ■ | 1 |
| 4210 45 | Key barrel and flat key for Padlocks | ■ | 1 |
| 4210 46 | Key barrel and star key for Padlocks | ■ | 1 |
| 4210 47 | Padlock accessory | ■ | 1 |

Connection accessories

| | | | |
|---------|---|------|---|
| 4210 26 | Set of 3 terminals for High capacity cage terminals | 6522 | 1 |
| 4210 27 | Set of 4 terminals for High capacity cage terminals | 8620 | 1 |
| 4210 70 | Set of 3 insulated shields | 144 | 1 |
| 4210 28 | Set of 3 terminals Screw terminals for copper bars connection | 740 | 1 |
| 4210 29 | Set of 4 terminals Screw terminals for copper bars connection | 886 | 1 |
| 6250 02 | Set of 3 spreaders for DPX ³ 160 3P | 400 | 1 |
| 6250 06 | Set of 4 spreaders for DPX ³ 160 4P | 600 | 1 |

Connection accessories

| | | | |
|---------|---|------|---|
| 4210 36 | Set of 3 rear terminals for DPX ³ 160 3P | 3488 | 1 |
| 4210 37 | Set of 4 rear terminals for DPX ³ 160 4P | 4678 | 1 |

Sealable terminal shields

For front terminals

| | | | |
|---------|-----------------------------|------|---|
| 4210 54 | For DPX ³ 160 3P | 3808 | 1 |
| 4210 55 | For DPX ³ 160 3P | 4022 | 1 |

For rear terminals

| | | | |
|---------|-----------------------------|------|---|
| 4210 50 | For DPX ³ 160 3P | 2408 | 1 |
| 4210 51 | For DPX ³ 160 4P | 2140 | 1 |

Fixing plates

| | | | |
|---------|--|-----|---|
| 4210 71 | For DPX ³ 160 3P / 4P without earth leakage module | 352 | 1 |
| 4210 73 | For DPX ³ 160 4P with earth leakage module | 864 | 1 |
| 4210 68 | For DPX ³ 160 3P / 4P with side mounting motor operator | 886 | 1 |

■ Price available on request.

* MRP - Maximum Retail Price Inclusive of all taxes including GST.

MCCB Prices are without spreaders. For ordering spreaders refer page no. 21

DPX³ 160 and 250 common auxiliaries and accessories



4210 58

| Cat.Nos | Description | MRP* ₹ / Unit | Pack |
|---------|-------------|---------------------|------|
|---------|-------------|---------------------|------|

Supply inverter type

| | | | |
|---------|----------------------------------|------|---|
| 4210 58 | For fixed version | 3214 | 1 |
| 4210 59 | For plug-in and draw-out version | 3426 | 1 |

Rotary handles

| | | | |
|---------|---|------|---|
| 4201 60 | Standard handle for thermal magnetic DPX ³ | 1074 | 1 |
| 4201 61 | Vari-depth standard handles | 1556 | 1 |
| 4201 67 | Key Lock for VD RH DPX ³ 160 & 250 | 1954 | 1 |
| 4201 65 | Key Lock for DIR RH Type A DPX ³ 160 & 250 | 1954 | 1 |
| 4201 68 | Key Lock for VD RH Type A DPX ³ 160 & 250 | 1954 | 1 |
| 4201 66 | Key Lock for DIR RH Type B DPX ³ 160 & 250 | 1954 | 1 |
| 4201 69 | Key Lock for VD RH Type B DPX ³ 160 & 250 | 1954 | 1 |

Motor-driven handles

| | | | |
|---------|--|-------|---|
| 4210 60 | Side motor operator | 28576 | 1 |
| 4210 61 | Front motor operator | 25670 | 1 |
| 4210 62 | Ronis key barrel for front motor operator | ■ | 1 |
| 4210 63 | Profalux key barrel for front motor operator | ■ | 1 |

DPX³ 160 and 250 common auxiliaries and accessories

| | | | |
|---------|---|-------|---|
| 4210 64 | Padlock for front motor operator | 1988 | 1 |
| 4210 65 | Ronis key barrel for side motor operator | 15470 | 1 |
| 4210 66 | Profalux key barrel for side motor operator | 14056 | 1 |
| 4210 67 | Padlock for side motor operator | 2112 | 1 |

Auxiliary contacts

| | | | |
|---------|--|------|---|
| 4210 10 | 1 N/C + 1 N/O auxiliary contact for rotary handles | 1370 | 1 |
| 4210 11 | Auxiliary contact or fault signalling contact | 1070 | 1 |
| 4210 48 | Signalling contact plugged-in/drawn-out (for DPX ³ plug-in version) | ■ | 1 |

Locking accessory

| | | | |
|---------|--|------|---|
| 4210 49 | Padlock for locking in "open" position | 1000 | 1 |
|---------|--|------|---|



4210 10



4210 11

Bold Cat.Nos are products normally available with Legrand (India) Stockists. Cat.Nos that are not bold - delivery within 4 - 8 weeks from the date of order. Bold packing quantity is our mandatory packing. Orders to be placed by Legrand (India) Stockist in multiples of the same.

DPX³ 250

equipment and mounting accessories

| Cat.Nos | Description | MRP* ₹ / Unit | Pack |
|---------|-------------|------------------|------|
|---------|-------------|------------------|------|

Equipment for plug-in version

| | | | |
|---------|--|---|---|
| 4210 42 | For DPX ³ 250 - 3P | ■ | 1 |
| 4210 43 | For DPX ³ 250 - 4P with or without earth leakage module | ■ | 1 |
| 4210 44 | Set of connectors for auxiliary contacts | ■ | 1 |
| 4210 45 | Key barrel and flat key N° ABA90GEL6149 for Padlocks | ■ | 1 |
| 4210 46 | Key barrel and star key N° HBA90GPS6149 for Padlocks | ■ | 1 |
| 4210 47 | Padlock accessory | ■ | 1 |

Connection accessories

| | | | |
|---------|-------------------------|------|---|
| 4210 30 | Set of 3 cage terminals | 2630 | 1 |
| 4210 31 | Set of 4 cage terminals | 3424 | 1 |
| 4210 70 | Set of 3 phase barriers | 144 | 1 |

Connection accessories

| | | | |
|---------|---|------|---|
| 6250 14 | Set of 3 spreaders for DPX ³ 250 3P | 608 | 1 |
| 6250 18 | Set of 4 spreaders for DPX ³ 250 4P | 808 | 1 |
| 4210 38 | Set of 3 rear terminals for DPX ³ 250 3P | 3524 | 1 |
| 4210 39 | Set of 4 rear terminals for DPX ³ 250 4P | 4744 | 1 |

Sealable terminal shields

For front terminals

| | | | |
|---------|-----------------------------|------|---|
| 4210 56 | For DPX ³ 250 3P | 3944 | 1 |
| 4210 57 | For DPX ³ 250 4P | 4176 | 1 |

For rear terminals

| | | | |
|---------|-----------------------------|------|---|
| 4210 52 | For DPX ³ 250 3P | 2354 | 1 |
| 4210 53 | For DPX ³ 250 4P | 2588 | 1 |

Fixing plates

| | | | |
|---------|--|------|---|
| 4210 72 | For DPX ³ 250 3P / 4P without earth leakage module | 352 | 1 |
| 4210 74 | For DPX ³ 250 4P with earth leakage module | 1494 | 1 |
| 4210 69 | For DPX ³ 250 3P / 4P with side mounting motor operator | 872 | 1 |

■ Price available on request.

* MRP - Maximum Retail Price Inclusive of all taxes including GST.

MCCB Prices are without spreaders. For ordering spreaders refer page no. 21

DPX³ 630

equipment and accessories

| Cat.Nos | Description | MRP* ₹ / Unit | Pack |
|---------|-------------|------------------|------|
|---------|-------------|------------------|------|

Plug-in version

| | | | |
|---------|---|---|---|
| 4222 20 | Set of incoming and outgoing terminals - 3P (6 terminals for 3P DPX ³ or 8 terminals for 4P DPX ³) | ■ | 1 |
| 4222 21 | Set of incoming and outgoing terminals - 4P (6 terminals for 3P DPX ³ or 8 terminals for 4P DPX ³) | ■ | 1 |
| 4222 22 | Front terminal mounting base for DPX ³ only - 3P | ■ | 1 |
| 4222 24 | Flat rear terminal mounting base for DPX ³ only - 3P | ■ | 1 |
| 4222 23 | Front terminal mounting base for DPX ³ only - 4P | ■ | 1 |
| 4222 25 | Flat rear terminal mounting base for DPX ³ only - 4P | ■ | 1 |
| 4222 26 | Front terminal mounting base for DPX ³ with earth leakage module - 4 P | ■ | 1 |
| 4222 27 | Flat rear terminal mounting base for DPX ³ with earth leakage module - 4P | ■ | 1 |
| 4222 37 | For fixing the signalling contact - 4P Cat.No 0265 74 on a DPX ³ plug-in version | ■ | 1 |
| 4222 28 | Set of 2 extractor handle | ■ | 1 |
| 4222 29 | Set of connectors (24-pin) | ■ | 1 |

Draw-out version

| | | | |
|---------|--|---|---|
| 4222 31 | "Debro-lift" mechanism for DPX ³ base only - 3P | ■ | 1 |
| 4222 32 | "Debro-lift" mechanism for DPX ³ base only - 4P | ■ | 1 |
| 4222 33 | "Debro-lift" mechanism for DPX ³ base with elm - 4P | ■ | 1 |
| 0265 76 | One key for "Debro-lift" mechanism for DPX ³ only - Flat key | ■ | 1 |
| 0265 78 | Two keys (one key supplied) for "Debro-lift" mechanism for motorised DPX ³ or with rotary handle - Flat key | ■ | 1 |
| 0263 48 | One key for "Debro-lift" mechanism for DPX ³ only - Star key | ■ | 1 |
| 0265 77 | Two keys (one key supplied) for motorised DPX ³ or with rotary handle - Star key | ■ | 1 |
| 0265 75 | Handle for drawing-out for "Debro-lift" mechanism | ■ | 1 |
| 0265 74 | Signalling contact (plugged-in/drawn-out) for "Debro-lift" mechanism | ■ | 1 |
| 4222 36 | For fixing the signalling contact Cat.No 0265 74 on a DPX ³ draw-out version | ■ | 1 |
| 4222 30 | Block of 6 automatic auxiliary contacts for DPX ³ draw-out version (up to 2 blocks by DPX ³) | ■ | 1 |

Bold Cat.Nos are products normally available with Legrand (India) Stockists. Cat.Nos that are not bold - delivery within 4 - 8 weeks from the date of order. Bold packing quantity is our mandatory packing. Orders to be placed by Legrand (India) Stockist in multiples of the same.

DPX³ 630 equipment and accessories

| Cat.Nos | Description | MRP* ₹ / Unit | Pack |
|---------|-------------|------------------|------|
|---------|-------------|------------------|------|

Supply inverter type

| | | | |
|---------|---|-------|---|
| 0264 09 | Plate for MCCB or trip-free switch fixed version | 8586 | 1 |
| 0264 04 | Plate for MCCB or trip-free switch plug-in and draw-out version | 13368 | 1 |

Rotary handles

| | | | |
|---------|--|------|---|
| 4201 62 | Direct rotary handle | 1718 | 1 |
| 4201 63 | Vari-depth rotary handle | 2954 | 1 |
| 4201 70 | Key Lock for VD RH DPX ³ 630 | 1954 | 1 |
| 4201 71 | Key Lock for VD RH Type A DPX ³ 630 | 1954 | 1 |
| 4201 72 | Key Lock for VD RH Type B DPX ³ 630 | 1954 | 1 |

Motor-driven handles

| | | | |
|---------|-------------------------------|-------|---|
| 0261 40 | Front operated 24 V \sim /= | 40172 | 1 |
| 0261 41 | Front operated 48 V \sim /= | 40172 | 1 |
| 0261 44 | Front operated 230 V \sim | 40172 | 1 |
| 0261 59 | Lock and flat key | 6772 | 1 |
| 0261 58 | Lock and star key | 14824 | 1 |

Accessories

| | | | |
|---------|---|------|---|
| 0262 30 | Set of 3 Insulated shields | 178 | 1 |
| 0262 44 | Set of 2 sealable terminal shields - 3P | 5158 | 1 |
| 0262 45 | Set of 2 sealable terminal shields - 4P | 1492 | 1 |

Accessories

| | | | |
|---------|--|-------|---|
| 0262 40 | Padlock for locking in "OPEN" position - 4P | 1802 | 1 |
| 0262 46 | Set of 4 adaptors + insulated shields for lug - 4P | 7052 | 1 |
| 0262 47 | Set of 4 extended front terminals - 4P | 5276 | 1 |
| 6250 04 | Set of incoming or outgoing spreaders - 3P | 1312 | 1 |
| 6250 08 | Set of incoming or outgoing spreaders - 4P | 1782 | 1 |
| 0263 50 | Set of incoming or outgoing swivel rear terminals - 3P | ■ | 1 |
| 0263 52 | Set of incoming or outgoing flat rear terminals - 3P | 17044 | 1 |
| 0263 51 | Set of incoming or outgoing swivel terminals - 4P | ■ | 1 |
| 0263 53 | Set of incoming or outgoing flat terminals - 4P | ■ | 1 |
| 4222 34 | Set of 2 IP 20 terminal covers - 3P | ■ | 1 |
| 4222 35 | Set of 2 IP 20 terminal covers - 4P | ■ | 1 |



0261 40



6250 04



4222 34



4222 35

■ Price available on request.

* MRP - Maximum Retail Price Inclusive of all taxes including GST.

DPX³ 630 earth leakage module

| Type and frame size | Rated Current (A) | Poles | Cat.Nos | MRP* ₹ / Unit | Pack |
|---------------------|-------------------|-------|---------|------------------|------|
|---------------------|-------------------|-------|---------|------------------|------|

Earth Leakage Module

Standard

| | | | | | |
|----------------------|-------|--------|---------|-------|---|
| DPX ³ 630 | 400 A | 3 Pole | 0260 60 | 31072 | 1 |
| | 630 A | 3 Pole | 0260 64 | 57862 | 1 |
| | 400 A | 4 Pole | 0260 61 | 57266 | 1 |
| | 630 A | 4 Pole | 0260 65 | 60360 | 1 |

LED Version

| | | | | | |
|----------------------|-------|--------|---------|---|---|
| DPX ³ 630 | 400 A | 4 Pole | 0260 63 | ■ | 1 |
| | 630 A | 4 Pole | 0260 67 | ■ | 1 |

DPX³ 1600 equipment and accessories

| Cat.Nos | Description | MRP* ₹ / Unit | Pack |
|---------|-------------|------------------|------|
|---------|-------------|------------------|------|

Draw-out version

| | | | |
|---------|---|---|---|
| 4225 86 | Front terminals - 3P | ■ | 1 |
| 4225 88 | Rear terminals - 3P | ■ | 1 |
| 4225 87 | Front terminals - 4P | ■ | 1 |
| 4225 89 | Rear terminals - 4P | ■ | 1 |
| 4225 93 | Debro-lift mechanism For DPX ³ 1600 - 3P | ■ | 1 |
| 4225 94 | Debro-lift mechanism for DPX ³ 1600 - 4P | ■ | 1 |
| 4225 95 | For fixing the signalling contact | ■ | 1 |
| | Cat.No 0265 74 on a DPX ³ draw-out version | | |
| 0265 76 | One key for "Debro-lift" mechanism for DPX ³ only - Flat key | ■ | 1 |
| 0265 80 | Two key (one key supplied) for motorised DPX ³ or with rotary handle | ■ | 1 |
| 0263 48 | One key for DPX ³ only - Starkey | ■ | 1 |
| 0265 79 | Two key (one key supplied) for motorised DPX ³ or with rotary handle | ■ | 1 |
| 0265 75 | Handle for drawing-out for "Debro-lift" mechanism | ■ | 1 |
| 0265 74 | Signalling contact (plugged-in/drawn-out) | ■ | 1 |
| 4222 30 | Block of 6 automatic auxiliary contacts for DPX ³ draw-out version (up to 2 blocks by DPX ³) | ■ | 1 |



4225 88
+
4225 93

Bold Cat.Nos are products normally available with Legrand (India) Stockists. Cat.Nos that are not bold - delivery within 4 - 8 weeks from the date of order. Bold packing quantity is our mandatory packing. Orders to be placed by Legrand (India) Stockist in multiples of the same.

DPX³ 1600 equipment and accessories

| Cat.Nos | Description | MRP* ₹ / Unit | Pack |
|---------|-------------|------------------|------|
|---------|-------------|------------------|------|

Supply inverter type

| | | | |
|---------|--|-------|---|
| 0264 10 | Plate for MCCBs or trip-free switch fixed version | 10854 | 1 |
| 0264 05 | Plate for MCCBs or trip-free switch plug-in and draw-out version | 22902 | 1 |

Rotary handles

| | | | |
|---------|---|-------|---|
| 0262 61 | Standard (black) direct on DPX ³ | 3570 | 1 |
| 0262 83 | Standard (black) vari-depth handle IP 55 | 4996 | 1 |
| 0262 93 | Key barrel and flat key | 2032 | 1 |
| 0262 94 | Key barrel and star key | 11212 | 1 |

Motor-driven handles

| | | | |
|---------|--|-------|---|
| 0261 54 | Front operated 230 VA | 75130 | 1 |
| 0261 24 | Front operated 24 VA/A for I _n ≤ 1250 A | 78930 | 1 |
| 0261 25 | Front operated 48 VA/A for I _n ≤ 1250 A | 89416 | 1 |

Motor-driven handles

| | | | |
|---------|---|-------|---|
| 0261 26 | Front operated 110 VA/A for I _n ≤ 1250 A | ■ | 1 |
| 0261 23 | Front operated 230 VA/A for I _n ≤ 1250 A | 49540 | 1 |
| 0261 19 | Front operated 24 VA/A for I _n = 1600 A | 79760 | 1 |
| 0261 28 | Front operated 48 VA/A for I _n = 1600 A | 68756 | 1 |
| 0261 29 | Front operated 110 VA/A for I _n = 1600 A | ■ | 1 |
| 0261 27 | Front operated 230 VA/A for I _n = 1600 A | 66684 | 1 |
| 0261 59 | Key and flat key | 6772 | 1 |
| 0261 58 | Key and star key | 14824 | 1 |

Accessories

| | | | |
|---------|---|-------|---|
| 0262 66 | Set of 3 insulated shields | 346 | 1 |
| 0262 64 | Set of 2 sealable terminal shields - 3P | 10476 | 1 |
| 0262 65 | Set of 2 sealable terminal shields - 4P | 2312 | 1 |
| 0262 60 | Padlock for locking in "open" position | 2086 | 1 |
| 0262 67 | Set of 4 extended front short terminals for 630 - 1250 A (2 bars max. per pole) | 12718 | 1 |



0262 60



0262 67
+
0262 68

- Price available on request.
- * MRP - Maximum Retail Price Inclusive of all taxes including GST.
- ◆ For Cat.Nos. and further details please contact th nearest branch.
- ▼ For communication add 4226 82 + 4226 89

DPX³ 630 and 1600 common auxiliaries

| Cat.Nos | Description | MRP* ₹ / Unit | Pack |
|---------|-------------|------------------|------|
|---------|-------------|------------------|------|

Accessories

| | | | |
|---------|--|-------|---|
| 0262 68 | Set of 4 extended front Long terminals for 1600 A (3 bars max. per pole) | 19680 | 1 |
| 4226 24 | Set of incoming or outgoing spreaders for 800 A & 1000 A - 3P | ■ | 1 |
| 4226 25 | Set of incoming or outgoing spreaders for 800 A & 1000 A - 4P | ■ | 1 |
| 0262 73 | Set of incoming or outgoing spreaders for 1250 A & 1600 A - 3P | ■ | 1 |
| 0262 74 | Set of incoming or outgoing spreaders for 1250 A & 1600 A - 4P | ■ | 1 |
| 0263 80 | Short rear terminals - 3P | ■ | 1 |
| 0263 81 | Long rear terminals - 3P | ■ | 1 |
| 0263 82 | Short rear terminals - 4P | ■ | 1 |
| 0263 83 | Long rear terminals - 4P | ■ | 1 |
| 4225 90 | Set of 2 IP 20 terminal covers - 3P | 1364 | 1 |
| 4225 91 | Set of 2 IP 20 terminal covers - 4P | 2218 | 1 |
| 4225 92 | External neutral - 4P | 12018 | 1 |

Common auxiliaries

| | | | |
|---------|--|------|---|
| 4210 11 | For signalling the state of the contacts or opening of the MCCB on a fault For DPX ³ /DPX ³ -I Changeover switch 3 A - 240 V± | 1070 | 1 |
|---------|--|------|---|

Releases

Allow remote tripping of a DPX³

Time-lag undervoltage releases (800 ms)

Prevent false tripping in the event of power supply microbreaks.

Require a time-lag module connected to the undervoltage release Cat.No 4226 23

| | | | |
|---------|------------------------------------|-------|---|
| 0261 90 | Time-lag module 230 VA 3 module | 19946 | 1 |
|---------|------------------------------------|-------|---|

Bold Cat.Nos are products normally available with Legrand (India) Stockists. Cat.Nos that are not bold - delivery within 4 - 8 weeks from the date of order. Bold packing quantity is our mandatory packing. Orders to be placed by Legrand (India) Stockist in multiples of the same.

DPX³ MCCB

Rotary handles for DPX³



- Smaller dimension of rotary handle base for better visibility of parameters and better access to trip unit
- Easy installation
- Spring for better play
- Door defeat mechanism for easy maintenance
- ON / OFF indication on the knob
- Pad Locking on the knob – upto 3 Locks

| Cat.Nos | Description | MRP* ₹ / Unit | Pack |
|---------|-------------|------------------|------|
|---------|-------------|------------------|------|

Releases

| | | | |
|---------|---|-------|---|
| 0261 91 | Time-lag module 400 VA 3 module | 29140 | 1 |
| 4226 23 | Undervoltage release for DPX ³ 630 and 1600 | ■ | 1 |

Automation control unit

| | | | |
|----------|----------------------|-------|---|
| 4226 80 | Standard unit | 27612 | 1 |
| 4226 82 | Advanced unit | 30122 | 1 |
| 4226 89▼ | Communication module | 8074 | 1 |

Residual current relay

| | | | |
|---------|--|-------|---|
| 0260 88 | Residual current relay to clip on module 2 rail | 20540 | 1 |
|---------|--|-------|---|

Coils

| | | | |
|---------|---------------------|---|---|
| 0260 92 | Coil Ø35 mm | ■ | 1 |
| 0260 93 | Coil Ø80 mm | ■ | 1 |
| 0260 94 | Coil Ø110 mm | ■ | 1 |
| 0260 95 | Coil Ø140 mm | ■ | 1 |
| 0260 96 | Coil Ø210 mm | ■ | 1 |
| 0260 97 | Coil Ø150 mm - open | ■ | 1 |
| 0260 98 | Coil Ø300 mm - open | ■ | 1 |

DPX³ ready-to-install ATS kit without MCCBs

| | | | |
|----------|---|--------|---|
| 6253 80* | Ready to use assembly for DPX ³ 160 | 244092 | 1 |
| 6253 81* | Ready to use assembly for DPX ³ 160 & DPX ³ 250 | 246334 | 1 |
| 6253 82* | Ready to use assembly for DPX ³ 250 | 306796 | 1 |
| 6253 87* | Ready to use assembly for DPX ³ 630 | 311482 | 1 |
| 6253 93 | Kit assembly for ATS for DPX ³ 160 | 17190 | 1 |
| 6253 94 | Kit assembly for ATS for DPX ³ 250 | 21702 | 1 |
| 6253 95 | Kit assembly for ATS for DPX ³ 630 | 28474 | 1 |

■ Price available on request.

* MRP - Maximum Retail Price Inclusive of all taxes including GST.

▼ For Cat.Nos. and further details please contact th nearest branch.

Bold Cat.Nos are products normally available with Legrand (India) Stockists. Cat.Nos that are not bold - delivery within 4 - 8 weeks from the date of order. Bold packing quantity is our mandatory packing. Orders to be placed by Legrand (India) Stockist in multiples of the same.



4226 82



0260 88



0260 93
coil for use
with relay



0260 98



6253 93

DRX

MCCB RANGE

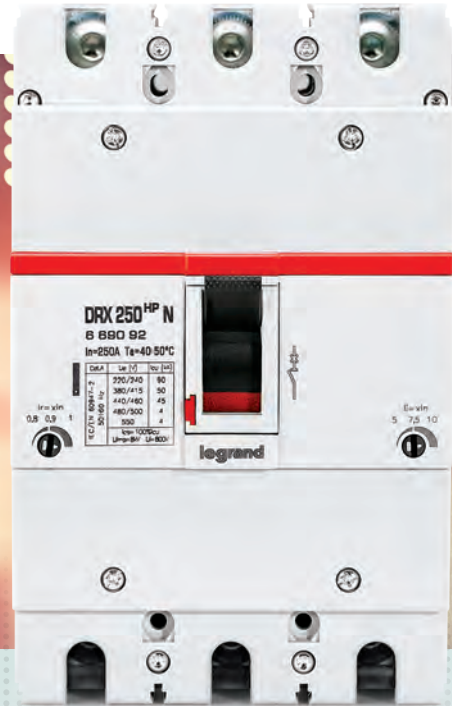

DRX MCCB WORLD CLASS SOLUTION WITH A RANGE OF ACCESSORIES AND WINNING FEATURES

NEW DRX 250HP AND DRX 630 COMPLETE RANGE. MULTIPLE FEATURES.

- Accurate performance at higher temperature " No Deration upto 50° Cel"
- Complete Range with Adjustable Protection
- Over - Temperature Alarm Indication
- Overload & Overload Pre-Alarm Indication
- In built Neutral Protection in 4th Pole
- Adjustable Time Settings
- Integrated Contact module for Status Indication
- Switchable Thermal Memory



A COMPREHENSIVE RANGE

The robust design of DRX 250HP and DRX 630 offer adjustable protection, different accessories for connection and remote tripping. They are the ideal choice in terms of efficiency and affordability for protection of your electrical installations of up to 630A.

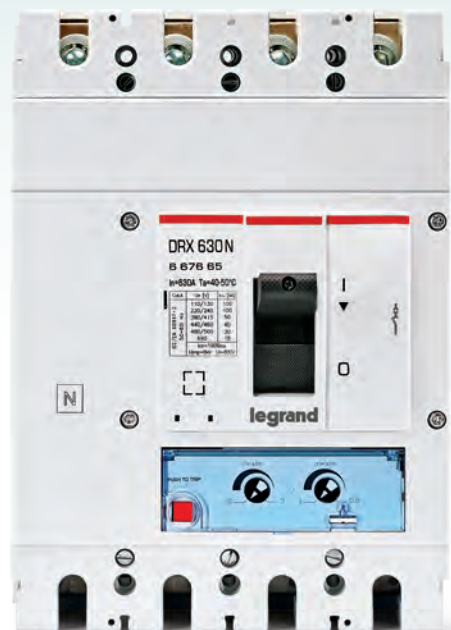

DRX MCCB

DRX MCCB with Thermal Magnetic Protection Unit

NEW!

- Range – 16A to 630A
- Ics = 100% Icu
- Thermal Adjustable – 0.8 to 1 In
- Magnetic Adjustable – 5 to 10 In starting from 50A
- Suitable for Isolation

| Category | Type | Rated Current (A) | 3P | | | 4P | | |
|----------|------|-------------------|---------|-------------|------|---------|-------------|------|
| | | | Cat.Nos | MRP*/₹/Unit | Pack | Cat.Nos | MRP*/₹/Unit | Pack |

Thermal Magnetic : O/L & S/C protection

| | | | | | | | | |
|-------|-----------------------|---------|---------|---------|---------|---------|-------|---|
| 25 KA | DRX 250 ^{HP} | 16 | 6690 00 | ■ | 1 | 6690 20 | ■ | 1 |
| | | 20 | 6690 01 | ■ | 1 | 6690 21 | ■ | 1 |
| | | 25 | 6690 02 | ■ | 1 | 6690 22 | ■ | 1 |
| | | 32 | 6690 03 | ■ | 1 | 6690 23 | ■ | 1 |
| | | 40 | 6690 04 | ■ | 1 | 6690 24 | ■ | 1 |
| | | 50 | 6690 05 | ■ | 1 | 6690 25 | ■ | 1 |
| | | 63 | 6690 06 | ■ | 1 | 6690 26 | ■ | 1 |
| | | 80 | 6690 07 | ■ | 1 | 6690 27 | ■ | 1 |
| | | 100 | 6690 08 | ■ | 1 | 6690 28 | ■ | 1 |
| | | 125 | 6690 09 | ■ | 1 | 6690 29 | ■ | 1 |
| | | 160 | 6690 10 | ■ | 1 | 6690 30 | ■ | 1 |
| | | 200 | 6690 11 | 14100 | 1 | 6690 31 | 18500 | 1 |
| 250 | 6690 12 | 17150 | 1 | 6690 32 | 21000 | 1 | | |
| 36 KA | DRX 250 ^{HP} | 16 | 6690 40 | ■ | 1 | 6690 60 | ■ | 1 |
| | | 20 | 6690 41 | ■ | 1 | 6690 61 | ■ | 1 |
| | | 25 | 6690 42 | ■ | 1 | 6690 62 | ■ | 1 |
| | | 32 | 6690 43 | ■ | 1 | 6690 63 | ■ | 1 |
| | | 40 | 6690 44 | ■ | 1 | 6690 64 | ■ | 1 |
| | | 50 | 6690 45 | ■ | 1 | 6690 65 | ■ | 1 |
| | | 63 | 6690 46 | ■ | 1 | 6690 66 | ■ | 1 |
| | | 80 | 6690 47 | ■ | 1 | 6690 67 | ■ | 1 |
| | | 100 | 6690 48 | ■ | 1 | 6690 68 | ■ | 1 |
| | | 125 | 6690 49 | ■ | 1 | 6690 69 | ■ | 1 |
| | | 160 | 6690 50 | ■ | 1 | 6690 70 | ■ | 1 |
| | | 200 | 6690 51 | 15500 | 1 | 6690 71 | 21650 | 1 |
| | 250 | 6690 52 | 18500 | 1 | 6690 72 | 22000 | 1 | |
| | DRX 630 | 320 | 6676 50 | 23200 | 1 | 6676 54 | 29600 | 1 |
| 400 | | 6676 51 | 23200 | 1 | 6676 55 | 29600 | 1 | |
| 500 | | 6676 52 | 27550 | 1 | 6676 56 | 34500 | 1 | |
| 630 | | 6676 53 | 27550 | 1 | 6676 57 | 36000 | 1 | |

■ Price available on request.

* MRP - Maximum Retail Price Inclusive of all taxes including GST.

Bold Cat.Nos are products normally available with Legrand (India) Stockists. Cat.Nos that are not bold - delivery within 4 - 8 weeks from the date of order. Bold packing quantity is our mandatory packing. Orders to be placed by Legrand (India) Stockist in multiples of the same.



6676 51

DRX MCCB

DRX MCCB with Thermal Magnetic Protection Unit

NEW!

| Category | Type | Rated Current (A) | 3P | | | 4P | | |
|----------|------|-------------------|---------|-------------|------|---------|-------------|------|
| | | | Cat.Nos | MRP*/₹/Unit | Pack | Cat.Nos | MRP*/₹/Unit | Pack |

Thermal Magnetic : O/L & S/C protection

| | | | | | | | | |
|-------|-----------------------|---------|---------|---------|---------|---------|---------|-------|
| 50 KA | DRX 250 ^{HP} | 16 | 6690 80 | ■ | 1 | 6691 00 | ■ | 1 |
| | | 20 | 6690 81 | ■ | 1 | 6691 01 | ■ | 1 |
| | | 25 | 6690 82 | ■ | 1 | 6691 02 | ■ | 1 |
| | | 32 | 6690 83 | ■ | 1 | 6691 03 | ■ | 1 |
| | | 40 | 6690 84 | ■ | 1 | 6691 04 | ■ | 1 |
| | | 50 | 6690 85 | ■ | 1 | 6691 05 | ■ | 1 |
| | | 63 | 6690 86 | ■ | 1 | 6691 06 | ■ | 1 |
| | | 80 | 6690 87 | ■ | 1 | 6691 07 | ■ | 1 |
| | | 100 | 6690 88 | ■ | 1 | 6691 08 | ■ | 1 |
| | | 125 | 6690 89 | ■ | 1 | 6691 09 | ■ | 1 |
| | | 160 | 6690 90 | ■ | 1 | 6691 10 | ■ | 1 |
| | | 200 | 6690 91 | 18100 | 1 | 6691 11 | 24500 | 1 |
| | | 250 | 6690 92 | 19500 | 1 | 6691 12 | 25200 | 1 |
| | | DRX 630 | 320 | 6676 58 | 25300 | 1 | 6676 62 | 31550 |
| 400 | 6676 59 | | 25300 | 1 | 6676 63 | 31550 | 1 | |
| 500 | 6676 60 | | 29900 | 1 | 6676 64 | 37700 | 1 | |
| 630 | 6676 61 | | 31000 | 1 | 6676 65 | 39100 | 1 | |



6690 92



6676 61

DRX MCCB

DRX MCCB with Electronic S2 (LSI) Protection Unit

- Range: 40A – 630A, Ics=100%Icu, Two Optimum Frames
- Protection against overloads:
 - Ir adjustable from 0.4 to 1 x In
 - tr adjustable from 3 to 30s#
- Protection against short circuits:
 - Isd adjustable from 1.5 to 10 x Ir
 - tsd adjustable from 0 to 0.5s
- Inbuilt Instantaneous Protection:
 - li# – Fixed
- Overload Alarm Indication - I > 1.05 Ir
- Pre-Overload Alarm Indication - I > 0.9 Ir
- Over temperature Alarm Indication - T > 90 °C
- Integrated Contact Module (On/Off/ Trip) for DRX 250HP Electronic MCCBs
- Suitable for Isolation

| Category | Type | Rated Current (A) | 3P | | | 4P | | |
|----------|------|-------------------|---------|-------------|------|---------|-------------|------|
| | | | Cat.Nos | MRP*/₹/Unit | Pack | Cat.Nos | MRP*/₹/Unit | Pack |

Electronic S2

| | | | | | | | | |
|-------|-----------------------|-----|---------|-------|---|---------|-------|---|
| 36 KA | DRX 250 ^{HP} | 40 | 6691 70 | 12500 | 1 | 6691 80 | 17000 | 1 |
| | | 100 | 6691 71 | 12500 | 1 | 6691 81 | 17000 | 1 |
| | | 160 | 6691 72 | 16300 | 1 | 6691 82 | 22800 | 1 |
| | | 250 | 6691 73 | 21850 | 1 | 6691 83 | 28500 | 1 |
| | DRX 630 | 320 | 6699 01 | 27600 | 1 | 6699 06 | 34000 | 1 |
| | | 400 | 6699 02 | 27600 | 1 | 6699 07 | 34000 | 1 |
| | | 630 | 6699 04 | 31000 | 1 | 6699 09 | 40600 | 1 |

* MRP - Maximum Retail Price Inclusive of all taxes including GST.
 ■ Price available on request.

Bold Cat.Nos are products normally available with Legrand (India) Stockists. Cat.Nos that are not bold - delivery within 4 - 8 weeks from the date of order. Bold packing quantity is our mandatory packing. Orders to be placed by Legrand (India) Stockist in multiples of the same.

DRX MCCB

DRX MCCB with Electronic S2 (LSI) Protection Unit

Electronic S2

NEW!

| | | | | | | | | |
|-------|-----------------------|----------------|----------------|-------|----------------|----------------|-------|---|
| 50 KA | DRX 250 ^{HP} | 40 | 6691 90 | 15800 | 1 | 6692 00 | 20800 | 1 |
| | | 100 | 6691 91 | 15800 | 1 | 6692 01 | 20800 | 1 |
| | | 160 | 6691 92 | 21350 | 1 | 6692 02 | 28550 | 1 |
| | 250 | 6691 93 | 27250 | 1 | 6692 03 | 32000 | 1 | |
| | DRX 630 | 320 | 6699 11 | 30200 | 1 | 6699 16 | 38500 | 1 |
| | | 400 | 6699 12 | 30200 | 1 | 6699 17 | 38500 | 1 |
| 630 | | 6699 14 | 33500 | 1 | 6699 19 | 42900 | 1 | |

DRX MCCB

DRX MCCB with Electronic Sg (LSIg) Protection Unit

- Range: 40A – 630A, Ics=100%Icu, Two Optimum Frames
- Protection against overloads:
 - Ir adjustable from 0.4 to 1 x In
 - tr adjustable from 3 to 30s#
- Protection against short circuits:
 - Isd adjustable from 1.5 to 10 x Ir
 - tsd adjustable from 0 to 0.5s
- Inbuilt Instantaneous Protection:
 - li# – Fixed
- Protection against Ground Fault:
 - Ig adjustable from 0.2 to 1 In & OFF
 - tg adjustable from 0.1 to 1s
- Overload Alarm Indication - I > 1.05 Ir
- Pre-Overload Alarm Indication - I > 0.9 Ir
- Over temperature Alarm Indication - T > 90 °C
- Integrated Contact Module (On/Off/ Trip) for DRX 250HP Electronic MCCBs
- Suitable for Isolation

| Category | Type | Rated Current (A) | 3P | | | 4P | | |
|----------|------|-------------------|---------|-------------|------|---------|-------------|------|
| | | | Cat.Nos | MRP*/₹/Unit | Pack | Cat.Nos | MRP*/₹/Unit | Pack |

Electronic Sg

| | | | | | | | | |
|-------|-----------------------|----------------|----------------|-------|----------------|----------------|-------|---|
| 36 KA | DRX 250 ^{HP} | 40 | 6691 75 | 21500 | 1 | 6691 85 | 25000 | 1 |
| | | 100 | 6691 76 | 21500 | 1 | 6691 86 | 25000 | 1 |
| | | 160 | 6691 77 | 24500 | 1 | 6691 87 | 30000 | 1 |
| | 250 | 6691 78 | 29000 | 1 | 6691 88 | 36000 | 1 | |
| | DRX 630 | 320 | 6699 21 | 40200 | 1 | 6699 26 | 46250 | 1 |
| | | 400 | 6699 22 | 40200 | 1 | 6699 27 | 46250 | 1 |
| 630 | | 6699 24 | 43500 | 1 | 6699 29 | 53800 | 1 | |
| 50 KA | DRX 250 ^{HP} | 40 | 6691 95 | 23500 | 1 | 6692 05 | 28500 | 1 |
| | | 100 | 6691 96 | 23500 | 1 | 6692 06 | 28500 | 1 |
| | | 160 | 6691 97 | 28000 | 1 | 6692 07 | 34000 | 1 |
| | 250 | 6691 98 | 31500 | 1 | 6692 08 | 38000 | 1 | |
| | DRX 630 | 320 | 6699 31 | 41600 | 1 | 6699 36 | 50200 | 1 |
| | | 400 | 6699 32 | 41600 | 1 | 6699 37 | 50200 | 1 |
| 630 | | 6699 34 | 44900 | 1 | 6699 39 | 56000 | 1 | |



6691 98

■ Price available on request.

* MRP - Maximum Retail Price Inclusive of all taxes including GST.

Bold Cat.Nos are products normally available with Legrand (India) Stockists. Cat.Nos that are not bold - delivery within 4 - 8 weeks from the date of order. Bold packing quantity is our mandatory packing. Orders to be placed by Legrand (India) Stockist in multiples of the same.

DRX MCCB

DRX MCCB Accessories

NEW!

| Frame | Accessory | CAT No. | MRP* ₹ / Unit | Pack |
|--------------------------|--|---------|------------------|------|
| DRX 250 ^{HP} | Shunt - 230V AC | 0271 54 | 1714 | 1 |
| | Shunt - 415V AC | 0271 55 | 1714 | 1 |
| | UV Coil - 230V AC | 0271 64 | 1986 | 1 |
| | UV Coil - 415V AC | 0271 65 | 2016 | 1 |
| | Auxilliary Contact | 0271 40 | 822 | 1 |
| | Trip Alarm Contact | 0271 41 | 840 | 1 |
| | Auxilliary + Trip Common Block | 0271 42 | 1380 | 1 |
| | Padlock | 0271 80 | 132 | 1 |
| | Phase Barriers- 3P | 6693 00 | 130 | 1 |
| | Phase Barriers - 4P | 6693 01 | 170 | 1 |
| | Direct Handle | 6687 72 | 950 | 1 |
| | Extended/ Vary Depth Handle | 6687 73 | 1500 | 1 |
| | Spreaders - 3P (set of 3) | 6250 14 | 608 | 1 |
| | Spreaders - 4P (Set of 4) | 6250 18 | 808 | 1 |
| | Direct handle random keylock - DRX 250 ^{HP} | 6687 74 | ■ | 1 |
| | Direct handle Typ A keylock-DRX 250 ^{HP} | 6687 75 | ■ | 1 |
| | Direct handle Typ B keylock-DRX 250 ^{HP} | 6687 76 | ■ | 1 |
| | Vary depth handle random keylock-DRX 250 ^{HP} | 6687 77 | ■ | 1 |
| | Vary depth handle type A keylock-DRX 250 ^{HP} | 6687 78 | ■ | 1 |
| | Vary depth handle type B keylock-DRX 250 ^{HP} | 6687 79 | ■ | 1 |

* MRP - Maximum Retail Price Inclusive of all taxes including GST.
■ Price available on request.

DRX MCCB

DRX MCCB Accessories

NEW!

| Frame | Accessory | CAT No. | MRP* ₹ / Unit | Pack |
|------------|--|---------|------------------|------|
| DRX 630 | Shunt - 230V AC | 4222 42 | 2062 | 1 |
| | Shunt - 415V AC | 4222 43 | 2062 | 1 |
| | UV Coil - 230V AC | 4222 48 | 2414 | 1 |
| | UV Coil - 415V AC | 4222 49 | 2414 | 1 |
| | Auxilliary Contact OR Trip Contact | 4210 11 | 1070 | 1 |
| | Padlock | 0262 40 | 1692 | 1 |
| | Phase Barriers | 0262 30 | 178 | 1 |
| | Direct Handle | 6687 80 | 1400 | 1 |
| | Extended/ Vary Depth Handle | 6687 81 | 2500 | 1 |
| | Spreaders - 3P | 6250 04 | 1312 | 1 |
| | Spreaders - 4P | 6250 08 | 1782 | 1 |
| | Vary depth handle random keylock-DRX 250 ^{HP} | 6687 82 | ■ | 1 |
| | Vary depth handle type A keylock-DRX 250 ^{HP} | 6687 83 | ■ | 1 |
| | Vary depth handle type B keylock-DRX 250 ^{HP} | 6687 84 | ■ | 1 |

Bold Cat.Nos are products normally available with Legrand (India) Stockists. Cat.Nos that are not bold - delivery within 4 - 8 weeks from the date of order. Bold packing quantity is our mandatory packing. Orders to be placed by Legrand (India) Stockist in multiples of the same.

LBPLUS DATA

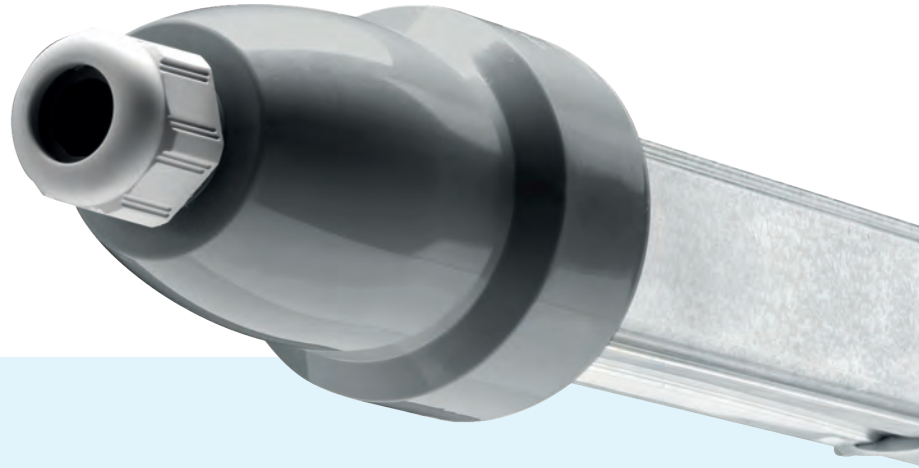

LIGHTING BUSBAR FOR EFFICIENT LIGHTING MANAGEMENT

SIMPLIFIED INSTALLATION FOR INCREASED PERFORMANCE



ENERGY EFFICIENCY

Integrate with dimming systems and lux meters for daytime electricity savings



SIMPLICITY WITH COMFORT

Completely addressable system for user convenience and remote management



MAXIMUM FLEXIBILITY OF USE

The certified protocols that can be used with LBplus data are the DALI and the 1-10 V protocols.



ENVIRONMENT SUSTAINABILITY

With the reduction of energy consumption, there is also an important reduction in the emission of polluting gases in the atmosphere. Renewable energy sources are not the only mean for reaching the environmental sustainability objectives: the starting point is certainly the reduction of existing consumptions



ENERGY SAVING

With LBplus data there is a reduction of both energy consumption due to artificial illumination (upto 75%, according to UNIEN 15193), and energy waste, thanks to the automatic management of lighting



COMPLIANCE WITH THE STANDARDS

With LBplus data, compliance with the EU Directives on energy efficiency both for new and for refurbished buildings is ensured



APPLICATIONS / CAN BE USED AT



SHOPPING CENTRES,
STORES, OFFICES...



WAREHOUSES, GYMS,
UNDERGROUND car parks...



HOSPITALS,
LABORATORIES...

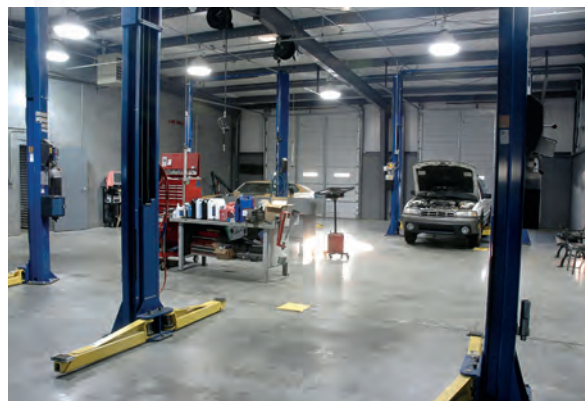

WORKSHOPS, MAINTENANCE & REPAIR
FACILITIES, PRODUCTION SITES...

IP68 RCP

RESIN BUSBAR
TRUNKINGS

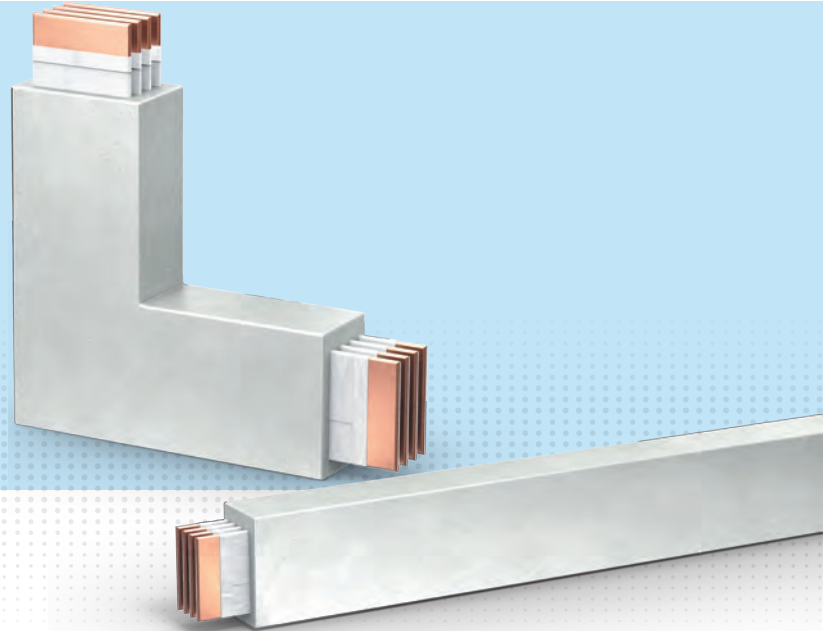

A SOLUTION THAT ADAPTS TO INDOOR AND OUTDOOR INSTALLATIONS

The **RCP IP68** resin busbar trunking system is a solution mainly for outdoor in extreme conditions such as humidity, corrosion or saline mist environment and temporary immersion risks.

RCP IP68 Resin Busbar

New resin busbar RCP with range from 630 A to 6300 A and IP68 degree of protection represents the complete solution for the **transport** of high-power energy.

This new product is made with internal conductors in aluminium or copper and completely embedded in a **epoxy resin**, which provides mechanical strength and electrical insulation. With RCP is possible to provide specific solutions in different environments (outdoor and indoor) where it isn't possible to reach with busbar IP55.

DEGREE OF PROTECTION

IP68

1ST DIGIT IP

Protection against penetration of solid bodies

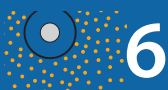

6

Complete protection against dust

2ND DIGIT IP

Protection against penetration of liquids



8

Protection against effects of Immersion under pressure

(At maximum of 1m, as comply by standard EN 61439-6)

BUSBAR TRUNKING

- Resin built-in conductors.
- Insulations of single conductors in polyester film.
- Fully insulated with epoxy resin.
- Rated current between 630 - 6300 A.
- Insulation voltage up to 1000 V.
- Small dimensions.
- Maintenance free.
- Only for Transport of energy.

CONDUCTOR MATERIAL

- Copper: copper busbars with a purity greater than 99.9% .
- Aluminium: aluminium alloy busbars, with entire surface treated with different galvanic processes.
- Degree of protection: IP68 according to the EN 61439-6.

Typical applications

The typical applications of IP68 busbar trunkings are



Industrial plants



Petrochemical plants



chemical plants (*).



outdoor (in different extreme conditions).

(*): attention at chemical components which are not compatible with the busbar's resin

E-communicating Infrastructure

| Cat.Nos | Description | MRP* ₹ / Unit | Pack |
|---------|-------------|------------------|------|
|---------|-------------|------------------|------|

Power Supervision System remote control, monitoring and measurement

Communication accessories for ACB

| | | | |
|---------|--|---|---|
| 0288 05 | Communication option - for DMX ³ electronic protection units (Factory Fitted) | ■ | 1 |
| 0288 06 | Power supply - external - 12 V DC - for DMX ³ electronic protection units | ■ | 1 |



0288 06

Communication Modules modules programmable output

Features

Programmable electronic device capable of controlling 6 relay outputs. The device can work in three different ways, with DMX3, with DPX3 or as Independent module depending on the product it is associated with

6 Programmable relay outputs with 230 V, 8 A contacts

Communication is ensured by the Modbus protocol.

| | | | |
|---------|-----------------------------|---|---|
| 0288 12 | modules programmable output | ■ | 1 |
|---------|-----------------------------|---|---|



0288 12

Signalling and control interface

Features

Signalling and control interface between the power supervision system and the **thermal magnetic or electronic circuit breakers**.

Equipped with analogue / digital inputs and relay outputs. Can handle multiple circuit breakers.

24 inputs for collecting information from the signalling

* MRP - Maximum Retail Price Inclusive of all taxes including GST.
(1) Price in Meters; No of meters in Pack, Standard length 2 meters to be ordered in multiple of 2 meters.

E-communicating Infrastructure

| Cat.Nos | Description | MRP* ₹ / Unit | Pack |
|---------|-------------|------------------|------|
|---------|-------------|------------------|------|

auxiliaries on the DPX3 and DMX³ circuit breakers: auxiliary contact NO position (1 input) or NO+NC position (2 inputs), fault signal (1 input)

6 outputs for: the remote control of the motor driven circuit breakers (2 outputs) and for tripping the circuit breakers (1 output)

Communication is ensured by the Modbus protocol.

Address, speed and coding can be modified with configuration kit.

| | | | |
|---------|----------------------------------|---|---|
| 0261 36 | signalling and control interface | ■ | 1 |
|---------|----------------------------------|---|---|



0261 36

Communication accessories for MCCB

Features

RS485 communication interface

Potential free contact for circuit breaker tripped status information max. 220 V 0.2 A

| | | | |
|---------|--|---|---|
| 4210 75 | DPX ³ electronic interface For connecting electronic DPX ³ to an RS485 Modbus communication network Note: 24 V _{DC} is required to power up the module | ■ | 1 |
| 4210 83 | Auxiliary power supply for DPX ³ - 24 V _{DC} - 250 mA | ■ | 1 |



4210 75



4210 83

Communication accessories for MCB

Features

RS485 communication interface

Potential free contact for circuit breaker tripped status information max. 220 V 0.2 A

Can be connected with DX3 add on Modules (4106 57/58/59)

Bold Cat.Nos are products normally available with Legrand (India) Stockists. Cat.Nos that are not bold - delivery within 4 - 8 weeks from the date of order. Bold packing quantity is our mandatory packing. Orders to be placed by Legrand (India) Stockist in multiples of the same.

COMMUNICATION ARCHITECTURE

PROTECTION



408614



DX³

408790

MEASUREMENT



412051

Earth Leakage Module with integrated measurement



4106 57

DPX³
Integrated measurement
From 40 to 1600 A



DMX³ with electronic protection unit

028803 + 028805



CONTROL AND SIGNALLING



406295+ 406252

Status auxiliaries and motorised controls



I/O interface
026136



028837



028815



026144

Status auxiliaries and motorised controls

+



I/O interface
026136

E-communicating Infrastructure

| Cat.Nos | Description | MRP* ₹ / Unit | Pack |
|---------|--|------------------|------|
| 4210 75 | DPX ³ electronic interface For connecting electronic DPX ³ to an RS485 Modbus communication network Note: 24 V= is required to power up the module | ■ | 1 |

Panel Board Display

Optional touch screen allowing to:
visualize information coming from DX³, DPX³ and DMX³ protection devices and EMDX³ multi-function measuring units and Can manage up to 9 devices
Power supply: 18-30 V=
IP connection
For mounting on door or solid faceplate
Door cut: 92 x 92 mm

| | | | |
|---------|----------------------------|-------|---|
| 0261 56 | Door mounting touch screen | 20266 | 1 |
|---------|----------------------------|-------|---|

Communication accessories

| | | | |
|----------------|--|---|---|
| 0261 45 | Configurator kit For configuring the DPX and DPX ³ I/O card and interface Kit with configurators 0 to 9 (10 configurators for each digit) | ■ | 1 |
| 0046 89 | IP converter For RS 485/ Ethernet conversion for connecting electricity meters and measurement control units to an IP network | ■ | 1 |
| 1466 23 | Stabilised switched modules power supply -single-phase -75-960 W-output 24 V= -120 W | ■ | 1 |



0261 56



0261 45



0046 89



1466 23

* MRP - Maximum Retail Price Inclusive of all taxes including GST.

▲ Finishing Plates to be ordered separately

Red Cat.Nos - new products

E-communicating Infrastructure

| Cat.Nos | Description | MRP* ₹ / Unit | Pack |
|---------|-------------|------------------|------|
|---------|-------------|------------------|------|

Energy management software for 1 computer (user licence key)

Allows remote configuration, test, control and visualization of data

30-day free trial version available for download via E-Catalogue

| | | | |
|---------|---|---|---|
| 4149 38 | Software licence agreement (user key) for 32 Modbus addresses or 32 pulse modules | ■ | 1 |
| 4149 39 | Software licence agreement (user key) 255 Modbus addresses or 255 pulse modules | ■ | 1 |

NEW! Energy management multi-support web servers

Allow remote configuration, test, control and visualization, via a web browser on PCs, smartphones, web viewers, tablet computers, of data Converter

Features

In-built IP converter

Power supply: 9 to 28 V= with the help of a single-phase switching mode power supply Cat.No 1 467 21 to be ordered separately

With the Legrand Power supervision system, circuit breakers are integrated in a supervision system

You can therefore check the status of the circuit breakers, measure the electrical values and control the circuit breakers remotely

MODBUS protocol

| | | | |
|----------------|---|---|---|
| 4149 47 | For 10 Modbus addresses or 10 pulse modules | ■ | 1 |
| 4149 48 | For 32 Modbus addresses or 32 pulse modules | ■ | 1 |
| 4149 49 | For 255 Modbus addresses or 255 pulse modules Supplied with external power supply and fixing brackets | ■ | 1 |



4149 48

Bold Cat.Nos are products normally available with Legrand (India) Stockists. Cat.Nos that are not bold - delivery within 4 - 8 weeks from the date of order. Bold packing quantity is our mandatory packing. Orders to be placed by Legrand (India) Stockist in multiples of the same.

COMMUNICATION



Interface
421075



I/O interface
026136



RS485
Interface for each DPX³
421075

Communication option 0288 05 +0288 06
for DMX³

Modbus RS485 network



RS485/IP
Interface
004689

REMOTE



026156
Touch screen

414938

Energy manager software (licence key) for local viewing and control on a workstation



Energy web server for local or remote viewing and control on various media
414948



IP Network
(https web pages)

NEW!

Power Supply

| Cat.Nos | Description | MRP* ₹ / Unit | Pack |
|--|---|------------------|------|
| Generic Power Supply for all your conversion needs from AC to DC Features Conform to standards UL 508, UL 60950, EN 61558-2-16 and IEC EN 60950-1, EN 55022 class B, EN 61000-3-2, EN 61000-3-3, EN 61000-6-2 and EN 61204-3 Operating frequency: 50/60 Hz Output voltage present indicator Output voltage adjustment potentiometer on front panel Integrated short-circuit and overload protection For mounting on a symmetrical rail depth 7.5 mm and 15 mm | | | |
| 1467 01 | Single-phase switching modules power supply - 15 W - input 100-240 V~ / output 24 V= | 4800 | 1 |
| 1467 11 | Single-phase switching modules power supply - 24 W - input 100-240 V~ / output 12 V= | 5200 | 1 |

* MRP - Maximum Retail Price Inclusive of all taxes including GST.
 (1) Price in Meters; No of meters in Pack, Standard length 2 meters to be ordered in multiple of 2 meters.

NEW!

Power Supply

| Cat.Nos | Description | MRP* ₹ / Unit | Pack |
|--|---|------------------|------|
|  1467 21 | | | |
| 1467 12 | Single-phase switching modules power supply - 54 W - input 100-240 V~ / output 12 V= | 5800 | 1 |
| 1467 21 | Single-phase switching modules power supply - 15 W - input 100-240 V~ / output 24 V= | 5100 | 1 |
| 1467 22 | Single-phase switching modules power supply - 36 W - input 100-240 V~ / output 24 V= | 5400 | 1 |
| 1467 23 | Single-phase switching modules power supply - 60 W - input 100-240 V~ / output 24 V= | 5900 | 1 |
| 1467 24 | Single-phase switching modules power supply - 92 W - input 100-240 V~ / output 24 V= | 6500 | 1 |

Bold Cat.Nos are products normally available with Legrand (India) Stockists. Cat.Nos that are not bold - delivery within 4 - 8 weeks from the date of order. **Bold packing quantity** is our mandatory packing. Orders to be placed by Legrand (India) Stockist in multiples of the same.

Switching Mode Power Supplies

single-phase

Generic power supply for all your conversion needs from AC to DC



1467 01

1467 12

1467 22

UL 508 approvals
 conforming to IES EN 60950-1, EN 61558-2-16
 Conforming to EN 55022 class B*, EN 61000-3-2 class A, EN 61000-3-3
 Conforming to EN 61000-4-2, 3, 4, 6 Level 3, criterion A
 EN 61000-4-5 and 8 level 4, criterion A
 EN 61204-3

*Class B means the power supply can be used in any environment, including residential

Features

- Operating frequency: 50/60 Hz
- Integrated short-circuit and overload protection on the power supply secondary
- Class II insulation
- Output voltage present indicator
- Output voltage adjustment potentiometer on front panel
- Output voltage variation: ±1%
- No-load power consumption less than 0.3w
- Cooling by natural convection
- Modular product

PMX

DIGITAL PANEL METERS

FOR ACCURATE
MONITORING AND
ENERGY SAVINGS.



WHY IS PMX PERFECT FOR YOUR FACILITY?



ROBUST

- Single function meter to advanced level MFM and demand controllers
- Ensures accurate wiring with ease
- Cost effective



ADAPTABLE

- Universal control power supply
- Site selectable CT/PT ratios
- Seamless integration with EMS/SCADA

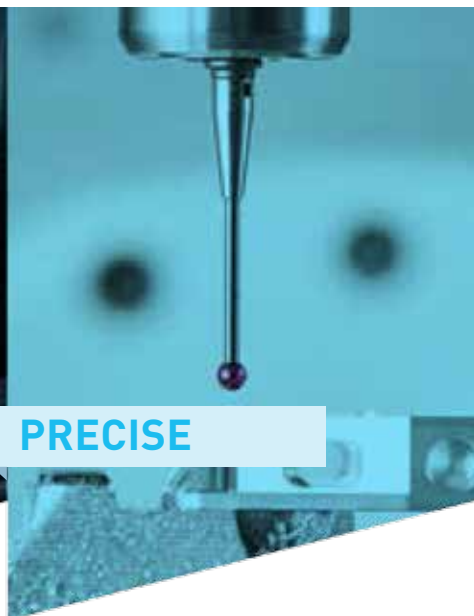

PRECISE

- True RMS measurement
- High accuracy class 1 & class 0.5 s
- Detailed measurements with auto-scaling

PMX Digital Panel Meters

NEW!

| Cat.Nos | Model Series | Description | MRP* ₹ / Unit | Pack |
|---------|--------------|-------------|------------------|------|
|---------|--------------|-------------|------------------|------|

PMX 1000 precise single function meters

Features

- **RoHS Compliance**
- True RMS measurement
- High accuracy with class 1 as per IEC 62053-21
- Volts & Amps: $\pm 1.0\%$ of Rated Current.
- **Bright 7 Segment LED display with four digit resolution and 14mm Height**
- Auto and Manual scrolling
- **Site selectable CT/PT ratios**
- Site selectable CT Secondary 1 A/5 A
- **Site selectable 3Phase 4Wire, 3Phase 3Wire & 1Ph configuration**
- Suitable for 50/60 Hz
- Wide range of control power supply 80 - 300 V AC, 40-70 Hz
- Low burden < 0.2 VA per phase Volts & Amps
- Average & Phase wise measurements
- Password protection

| | | | | |
|----------------|----------|-------------------------|------|---|
| 4149 75 | PMX 1100 | 1Ph Ammeter CI 1 | 1138 | 1 |
| 4149 76 | PMX 1200 | 1Ph Voltmeter CI 1 | 1138 | 1 |
| 4149 77 | PMX 1103 | 3Ph Ammeter CI 1 | 1678 | 1 |
| 4149 78 | PMX 1203 | 3Ph Voltmeter CI 1 + Hz | 1678 | 1 |



4149 77



4149 78

PMX 4000 true VAF + PF meter

Features

- **RoHS Compliance**
- **Displays Current, line to neutral & line to line Voltages, frequency & Power Factor. (VA & PF - Phase Wise & Average)**
- **Display on Hours**
- True RMS measurement with simulations sampling of Current & Voltage
- High accuracy with class 1 as per IEC 62053-21
Volts & Amps: $\pm 1.0\%$ of Rated Current.
- **3 Row Display with LED status for different parameter selection.**
- Auto and Manual scrolling
- Site selectable CT/PT ratios
- Site selectable CT Secondary 1 A/5 A
- Site selectable 3Phase 4Wire, 3Phase 3Wire & 1Ph configuration
- Suitable for 50/60 Hz
- Universal control power supply 80 - 300 V AC/DC, 40-70 Hz
- Low burden < 0.2 VA per phase Volts & Amps
- Average & Phase wise measurements
- **Password protection**
- **Seamless integration with EMS/SCADA system with RS485 serial channel communication,**



4149 82

PMX Digital Panel Meters

NEW!

| Cat.Nos | Model Series | Description | MRP* ₹ / Unit | Pack |
|---------|--------------|-------------|------------------|------|
|---------|--------------|-------------|------------------|------|

Industry standard Modbus RTU protocol.

| | | | | |
|----------------|----------|------------------------------------|------|---|
| 4149 79 | PMX 4000 | 3Ph VAF + PF meter CI 1 | 2936 | 1 |
| 4149 80 | PMX 4000 | 3Ph VAF + PF meter CI 1 with RS485 | 3502 | 1 |



4149 80

PMX 5000 smart energy meters for smart energy billing

Features

- **RoHS Compliance**
- kWh/kVA
- **Old Energy register for back up of last cleared energy values**
- Bright LED with parameter name and value
- Auto scaling capability in adjustment of Kilo, Mega, Giga.
- kWh / kVA / PF / W - any one programmable
- **Positive energy accumulation even with CT polarity reversal with reverse lock program**
- High Accuracy with class 1 as per IEC 62053-21
- Site selectable CT/PT ratios
- Site selectable CT Secondary 1 A/5 A
- Universal control power supply 80 - 300 V AC/DC, 40-70 Hz
- Password protection for tamper proofing
- **Seamless integration with EMS/SCADA system with RS485 serial channel communication, Industry standard Modbus RTU protocol.**
- **Pulse output for integration into a process through PLC/DCS for online energy management**
- Provision for Tamper proofing with meter casing*
*optional strip for tamper proofing.

| | | | | |
|----------------|----------|--------------------------------------|------|---|
| 4149 81 | PMX 5000 | kWh LED meter CI 1 | 3296 | 1 |
| 4149 82 | PMX 5000 | kWh LED meter CI 1 with RS485 | 3800 | 1 |
| 4149 83 | PMX 5000 | kWh LED meter CI 1 with Pulse Output | 4430 | 1 |

PMX 6000 multi dual source meter

Features

- **RoHS Compliance**
- **Bright LED display for showing parameters for both EB & DG**
- **Displays full range of parameters**
Basic : VLL, VLN, A (Avg. & Phase wise), F
Power: W, PF (Avg. & Phase wise)
Energy: Wh
- **Load Hours, Run Hours, Old Wh, Old Load Hours for both EB & DG.**
- **DG Sensing input - 230 VAC**
- Auto scaling capability in adjustment of Kilo, Mega, Giga.
- Positive energy accumulation even with CT polarity reversal with reverse lock program.
- High Accuracy with class 1 as per IEC 62053-21 & class 0.5 as per IEC 62053-22

Bold Cat.Nos are products normally available with Legrand (India) Stockists. Cat.Nos that are not bold - delivery within 4 - 8 weeks from the date of order. Bold packing quantity is our mandatory packing. Orders to be placed by Legrand (India) Stockist in multiples of the same.

PMX Digital Panel Meters

NEW!

| Cat.Nos | Model Series | Description | MRP* ₹ / Unit | Pack |
|---------|--------------|-------------|------------------|------|
|---------|--------------|-------------|------------------|------|

- Site selectable CT/PT ratios
- Site selectable CT Secondary 1 A/5 A
- Universal control power supply 80 – 300 V AC/DC, 40-70 Hz
- Password protection for tamper proofing
- **Seamless integration with EMS/SCADA system with RS485 serial channel communication, Industry standard Modbus RTU protocol.**
- Provision for Tamper proofing with meter casing*
*optional strip for tamper proofing



4149 85

| | | | | |
|----------------|----------|---|------|---|
| 4149 84 | PMX 6000 | Dual Source LED meter CI 1 with RS485 | 5264 | 1 |
| 4149 85 | PMX 6000 | Dual Source LED meter CI 0.5 with RS485 | 6334 | 1 |

PMX 7000 multifunction meter

Features

- **RoHS Compliance**
- **Bright LED display to view more than 25 parameters.**
- Displays full range of parameters
Basic : VLL, VLN, A (Avg. & Phase Wise), F
Power: W, PF, VA (Avg. & Phase Wise)
Energy: Wh,
- **Load Hours, Run Hours, Old Wh, Old Load Hours**
- Auto scaling capability in adjustment of Kilo, Mega, Giga.
- **Positive energy accumulation even with CT polarity reversal with reverse lock programmable**
- High Accuracy with class 1 as per IEC 62053-21
- Site selectable CT/PT ratios
- Site selectable CT Secondary 1 A/5 A
- Universal control power supply 80 – 300 V AC/DC, 40-70 Hz
- Password protection for tamper proofing
- **Seamless integration with EMS/SCADA system with RS485 serial channel communication, Industry standard Modbus RTU protocol**
- Provision for Tamper proofing with meter casing*
*optional strip for tamper proofing



4149 90



4149 91

| | | | | |
|----------------|----------|---|------|---|
| 4149 90 | PMX 7000 | MFM (VAF + W/VA/PF/Wh) LED meter CI 1 with RS485 [^] | 5048 | 1 |
| 4149 91 | PMX 7300 | MFM LED meter CI 1 | 6128 | 1 |
| 4149 92 | PMX 7300 | MFM LED meter CI 1 with RS485 | 7314 | 1 |

PMX Digital Panel Meters

NEW!

| Cat.Nos | Model Series | Description | MRP* ₹ / Unit | Pack |
|---------|--------------|-------------|------------------|------|
|---------|--------------|-------------|------------------|------|

PMX 7400 advance multifunction meter / load manager / demand monitor

Features

- **RoHS Compliance**
- **Advance multifunction meter with High/Low recording of VLL, VLN, A, Hz, PF, Var with time stamp.**
- **Voltage & Current THD (Total Harmonics Distortion) with Individual harmonics up to 31st order.**
- **K-factor V & A to keep check on the losses due to harmonic load currents & their effects on transformer heating.**
- Load manager with demand monitoring
- **RTC based Demand management**
- **Import/Export/Net monitoring of Wh, VAh, VARh Inductive/Capacitive, Load hours**
- Auto scaling capability in adjustment of Kilo, Mega, Giga.
- **Positive energy accumulation even with CT polarity reversal with reverse lock programmable**
- High Accuracy with class 1 as per IEC 62053-21 & class 0.5s as per IEC 62053-22
- Site selectable CT/PT ratios
- Site selectable CT Secondary 1 A/5 A
- Universal control power supply 80-300 V AC/DC, 40-70 Hz
- Password protection for tamper proofing
- **Seamless integration with EMS/SCADA system with RS485 serial channel communication, Industry standard Modbus RTU protocol.**
- Byte order option – Field Programmable Float/ Little Endian/ Big Endian data formats

| | | | | |
|----------------|----------|--|-------|---|
| 4149 93 | PMX 7400 | MFM + THD LED meter CI 1 with RS485 | 9786 | 1 |
| 4149 94 | PMX 7400 | MFM + THD LED meter CI 0.5 with RS485 | 11948 | 1 |
| 4149 95 | PMX 7410 | MFM + THD + Demand monitoring LED meter CI 1 with RS485 | 14214 | 1 |
| 4149 96 | PMX 7420 | MFM + THD with Individual + Harmonics + Demand + Import/Export LED meter CI 1 with RS485 | 14730 | 1 |



4149 96

Bold Cat.Nos are products normally available with Legrand (India) Stockists. Cat.Nos that are not bold - delivery within 4 - 8 weeks from the date of order. Bold packing quantity is our mandatory packing. Orders to be placed by Legrand (India) Stockist in multiples of the same.

PMX
Digital Panel Meters

NEW!

| Cat.Nos | Model Series | Description | MRP* ₹ / Unit | Pack |
|---------|--------------|---|------------------|------|
| 4149 97 | PMX 7420 | MFM + THD with Individual + Harmonics + Demand + Import/Export LED meter CI 0.5s with RS485 | 16790 | 1 |

PMX 8000
advance demand controller

Features

- **RoHS Compliance**
- **Demand controller with 4 relay output**
- **High memory Data Logger (8MB) for storing multiple parameters.**
- **Predictive demand with date & time stamping**
- **Voltage & Current THD (Total Harmonics Distortion) with Individual harmonics up to 31st order.**
- **K-factor V & A to keep check on the losses due to harmonic load currents & their effects on transformer heating.**
- **Advance multifunction meter with High/Low recording of VLL, VLN, A, Hz, PF, Var with time stamp.**
- **RTC based Demand management**
- **Import/Export/Net monitoring of Wh, VAH, VARh Inductive/Capacitive, Load hours**
- **Auto scaling capability in adjustment of Kilo, Mega, Giga.**
- **Positive energy accumulation even with CT polarity reversal with reverse lock programmable**
- **High Accuracy with class 1 as per IEC 62053-21**
- **Site selectable CT/PT ratios**
- **Site selectable CT Secondary 1 A/5 A**
- **Universal control power supply 80 - 300 V AC/DC, 40-70 Hz**
- **Password protection for tamper proofing**
- **Seamless integration with EMS/SCADA system with RS485 serial channel communication, Industry standard Modbus RTU protocol.**
- **Byte order option - Field Programmable Float/ Little Endian/ Big Endian data formats**



4149 98

| | | | | |
|---------|----------|--|-------|---|
| 4149 98 | PMX 8000 | Demand Controller CI 1 with data logger + Bi directional + THD with Individual Harmonics | 32548 | 1 |
|---------|----------|--|-------|---|

CTX³ MINI:

AN ULTRA-COMPACT SOLUTION UP TO 16 A

With their compact size, CTX³ MINI are easy to integrate in control panels or distribution boards for switching motors, lighting and heating circuits up to 16 A.



CTX³ MINI: MOUNTING ON DIN RAIL OR ON PLATE

- 1 IP 2X screw terminals
- 2 Integrated auxiliary contact (3P only)
- 3 A1 and A2 supply terminal block

CTX³ RTX³ MPX³

UNCOMPROMISING
PERFORMANCE FOR
MOTOR PROTECTION
AND CONTROL

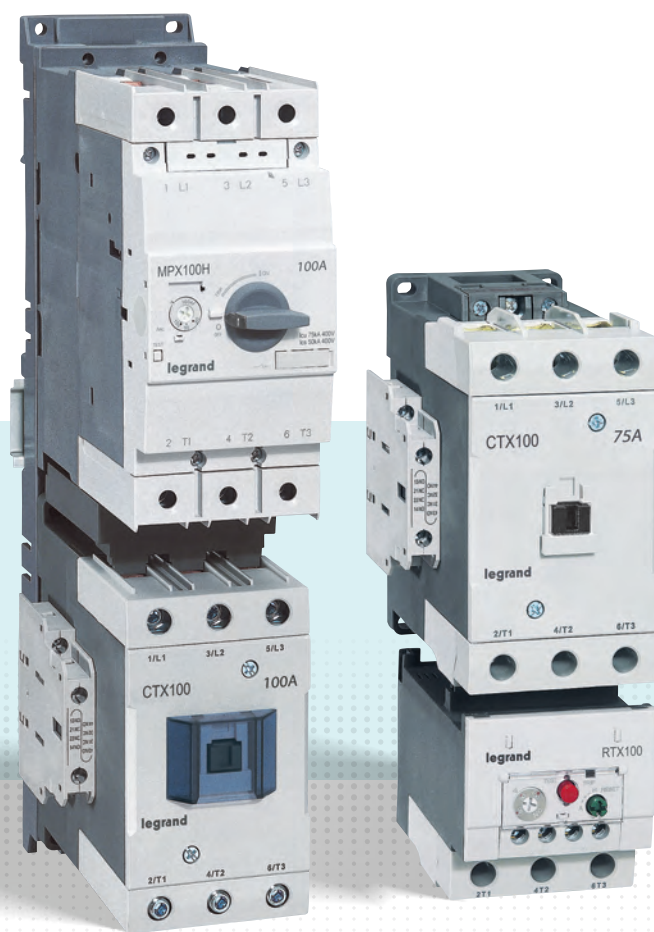

A COMPLETE RANGE OF DEVICES FOR THE PROTECTION AND CONTROL OF MOTORS

CTX³ CONTACTORS AND RTX³ THERMAL RELAYS UP TO 800 A

- Compact size
- High mechanical and electrical endurance for maximum reliability
- Lowest watt loss
- 3-Pole and 4-pole contactors
- Screw terminals
- Complete range of auxiliaries and accessories

MPX³ MOTOR PROTECTION CIRCUIT BREAKERS UP TO 100 A

- High breaking capacity and type 2 coordination for an optimum service level
- Trip class 10
- Sensitive to phase loss
- Compact size
- Can be fixed on 35 mm DIN rail or using screws
- Easy combination with CTX³ 3-pole contactors
- Complete range of control and signalling auxiliaries and accessories

Mini contactors CTX³ 6 to 16 A industrial contactors

| Cat.Nos | Max. opt. current AC 3 | Max. opt. current AC 1 | Control voltage | MRP* ₹ / Unit | Pack |
|---------|------------------------|------------------------|-----------------|---------------|------|
|---------|------------------------|------------------------|-----------------|---------------|------|

An Ultra Compact Solution Upto 16A (AC3) 3P & 4P

For Switching Motors, Lighting and Heating Circuits
Ultra High Reliability
Ultra High Endurance
Ultra Low Wattloss

Features

Conforms to IEC/EN 60947-4-1
CE & UL Certified
Range From 6A to 16A AC3
Available in 3P & 4P
Click fit accessories
Ultra Compact design
Front and side add on auxiliary contact
Mechanical Interlock unit
mini Thermal Overload Relay

Spare Coils available

RoHS Compliant

3 pole mini contactors

With integrated auxiliary contact
Power terminals: screw terminals

6 A - Integrated auxiliary contact 1 NO

| | | | | | |
|---------|-----|------|--------|------|---|
| 4170 00 | 6 A | 20 A | 24 V~ | 982 | 1 |
| 4170 01 | 6 A | 20 A | 24 V= | 1472 | 1 |
| 4170 04 | 6 A | 20 A | 110 V~ | 982 | 1 |
| 4170 06 | 6 A | 20 A | 230 V~ | 982 | 1 |
| 4170 09 | 6 A | 20 A | 415 V~ | 982 | 1 |

6 A - Integrated auxiliary contact 1 NC

| | | | | | |
|---------|-----|------|--------|------|---|
| 4170 10 | 6 A | 20 A | 24 V~ | 982 | 1 |
| 4170 11 | 6 A | 20 A | 24 V= | 1472 | 1 |
| 4170 14 | 6 A | 20 A | 110 V~ | 982 | 1 |
| 4170 16 | 6 A | 20 A | 230 V~ | 982 | 1 |
| 4170 19 | 6 A | 20 A | 415 V~ | 982 | 1 |

9 A - Integrated auxiliary contact 1 NO

| | | | | | |
|---------|-----|------|--------|------|---|
| 4170 20 | 9 A | 20 A | 24 V~ | 1076 | 1 |
| 4170 21 | 9 A | 20 A | 24 V= | 1564 | 1 |
| 4170 24 | 9 A | 20 A | 110 V~ | 1076 | 1 |
| 4170 26 | 9 A | 20 A | 230 V~ | 1076 | 1 |
| 4170 29 | 9 A | 20 A | 415 V~ | 1076 | 1 |

9 A - Integrated auxiliary contact 1 NC

| | | | | | |
|---------|-----|------|--------|------|---|
| 4170 30 | 9 A | 20 A | 24 V~ | 1076 | 1 |
| 4170 31 | 9 A | 20 A | 24 V= | 1564 | 1 |
| 4170 34 | 9 A | 20 A | 110 V~ | 1076 | 1 |
| 4170 36 | 9 A | 20 A | 230 V~ | 1076 | 1 |
| 4170 39 | 9 A | 20 A | 415 V~ | 1076 | 1 |

12 A - Integrated auxiliary contact 1 NO

| | | | | | |
|---------|------|------|--------|------|---|
| 4170 40 | 12 A | 20 A | 24 V~ | 1166 | 1 |
| 4170 41 | 12 A | 20 A | 24 V= | 1916 | 1 |
| 4170 44 | 12 A | 20 A | 110 V~ | 1166 | 1 |
| 4170 46 | 12 A | 20 A | 230 V~ | 1166 | 1 |
| 4170 49 | 12 A | 20 A | 415 V~ | 1166 | 1 |

12 A - Integrated auxiliary contact 1 NC

| | | | | | |
|---------|------|------|--------|------|---|
| 4170 50 | 12 A | 20 A | 24 V~ | 1166 | 1 |
| 4170 51 | 12 A | 20 A | 24 V= | 1916 | 1 |
| 4170 54 | 12 A | 20 A | 110 V~ | 1166 | 1 |
| 4170 56 | 12 A | 20 A | 230 V~ | 1166 | 1 |
| 4170 59 | 12 A | 20 A | 415 V~ | 1166 | 1 |

* MRP - Maximum Retail Price Inclusive of all taxes including GST.

Mini contactors CTX³ 6 to 16 A industrial contactors

| Cat.Nos | Max. opt. current AC 3 | Max. opt. current AC 1 | Control voltage | MRP* ₹ / Unit | Pack |
|---------|------------------------|------------------------|-----------------|---------------|------|
|---------|------------------------|------------------------|-----------------|---------------|------|

16 A - Integrated auxiliary contact 1 NO

| | | | | | |
|---------|------|------|--------|------|---|
| 4170 60 | 16 A | 20 A | 24 V~ | 1404 | 1 |
| 4170 61 | 16 A | 20 A | 24 V= | 2220 | 1 |
| 4170 64 | 16 A | 20 A | 110 V~ | 1404 | 1 |
| 4170 66 | 16 A | 20 A | 230 V~ | 1404 | 1 |
| 4170 69 | 16 A | 20 A | 415 V~ | 1404 | 1 |

16 A - Integrated auxiliary contact 1 NC

| | | | | | |
|---------|------|------|--------|------|---|
| 4170 70 | 16 A | 20 A | 24 V~ | 1404 | 1 |
| 4170 71 | 16 A | 20 A | 24 V= | 2220 | 1 |
| 4170 74 | 16 A | 20 A | 110 V~ | 1404 | 1 |
| 4170 76 | 16 A | 20 A | 230 V~ | 1404 | 1 |
| 4170 79 | 16 A | 20 A | 415 V~ | 1404 | 1 |

4-pole mini contactors

Without integrated auxiliary contact
Power terminals: screw terminals

| Cat.Nos | Max. opt. current AC 1 | Max. opt. current AC 3 | Control voltage | MRP* ₹ / Unit | Pack |
|---------|------------------------|------------------------|-----------------|---------------|------|
|---------|------------------------|------------------------|-----------------|---------------|------|

20 A

| | | | | | |
|---------|------|------|--------|------|---|
| 4171 40 | 20 A | 16 A | 24 V~ | 1320 | 1 |
| 4171 41 | 20 A | 16 A | 24 V= | 2072 | 1 |
| 4171 44 | 20 A | 16 A | 110 V~ | 1320 | 1 |
| 4171 46 | 20 A | 16 A | 230 V~ | 1320 | 1 |
| 4171 49 | 20 A | 16 A | 415 V~ | 1320 | 1 |

Mini Thermal Overload Relays RTX³ mini

for mini contactors

| Cat.Nos | Setting Range | MRP* ₹ / Unit | Pack |
|---------|---------------|---------------|------|
|---------|---------------|---------------|------|

Features

Conforms to IEC/EN 60947-4-1
CE & UL Certified
Thermal protection of circuits against overload, long starting times, and phase failure
Trip Class 10A
Trip Indication
Manual/Automatic Reset
Integrated auxiliary contacts 1 NO & 1 NC

Thermal overload relays for 3 pole mini contactors

Class 10 A - Integrated auxiliary contacts 1 NO + 1 NC

| | | | |
|---------|-------------|------|---|
| 4170 80 | 0.1~0.16 A | 1174 | 1 |
| 4170 81 | 0.16~0.25 A | 1174 | 1 |
| 4170 82 | 0.25~0.4 A | 1174 | 1 |
| 4170 83 | 0.4~0.63 A | 1174 | 1 |
| 4170 84 | 0.63~1 A | 1174 | 1 |
| 4170 85 | 1~1.6 A | 1174 | 1 |
| 4170 86 | 1.6~2.5 A | 1174 | 1 |
| 4170 87 | 2.5~4 A | 1174 | 1 |
| 4170 88 | 4~6 A | 1174 | 1 |
| 4170 89 | 5~8 A | 1174 | 1 |
| 4170 90 | 6~9 A | 1174 | 1 |
| 4170 91 | 7~10 A | 1174 | 1 |
| 4170 92 | 9~13 A | 1174 | 1 |
| 4170 93 | 12~16 A | 1174 | 1 |



4170 88

Bold Cat.Nos are products normally available with Legrand (India) Stockists. Cat.Nos that are not bold - delivery within 4 - 8 weeks from the date of order. Bold packing quantity is our mandatory packing. Orders to be placed by Legrand (India) Stockist in multiples of the same.

Mini Thermal Overload Relays

RTX³ mini

Accessories for mini Contactors CTX³

| Cat.Nos | Setting Range | MRP* ₹ / Unit | Pack |
|---------|---------------|------------------|------|
|---------|---------------|------------------|------|

Add on auxiliary blocks for mini contactors

High Thermal current - 10 A
lth: 10 A

Front mounting

| | | | |
|---------|-------------|-----|----|
| 4171 50 | 1 NO + 1 NC | 348 | 10 |
| 4171 51 | 2 NO | 348 | 10 |
| 4171 52 | 2 NC | 348 | 10 |
| 4171 53 | 4 NO | 530 | 10 |
| 4171 54 | 3 NO + 1 NC | 530 | 10 |
| 4171 55 | 2 NO + 2 NC | 530 | 10 |
| 4171 56 | 1 NO + 3 NC | 530 | 10 |
| 4171 57 | 4 NC | 530 | 10 |

Side mounting

| | | | |
|---------|------|-----|----|
| 4171 58 | 1 NO | 348 | 10 |
| 4171 59 | 1 NC | 348 | 10 |

Interlock Unit

| | | | |
|---------|--|-----|---|
| 4171 60 | Mechanical interlock for mini contactors | 556 | 5 |
|---------|--|-----|---|

Spare coils

| | | | |
|---------|--------|-----|---|
| 4171 70 | 24 V~ | 638 | 5 |
| 4171 71 | 24 V= | 866 | 5 |
| 4171 74 | 110 V~ | 638 | 5 |
| 4171 76 | 230 V~ | 638 | 5 |
| 4171 79 | 415 V~ | 638 | 5 |

Power contactors CTX³

Uncompromising Performance for

Motor Protection & Control

Range from 9A to 800A (AC3) Contactors

Features

Conforms to IEC/EN 60947-4-1
CE & UL Certified
Extra Mechanical life upto 15 Million
Extra Electrical life upto 2.5 Million
Extra Low Consumption
Compact size
integrated auxiliary contacts

Front safety Cover to prevent dust entry

Direct Clipping on Din Rail

Both Sides Terminal connection

Click fit accessories

Interlocking kits

Spare Coils

RoHS Compliant

3 pole contactors CTX³

9 A to 100 A industrial contactors

| Cat.Nos | Max. opt. current AC 3 | Max. opt. current AC 1 | Control voltage | MRP* ₹ / Unit | Pack |
|---------|---------------------------|---------------------------|-----------------|------------------|------|
|---------|---------------------------|---------------------------|-----------------|------------------|------|

CTX³ 22

With integrated auxiliary contacts

Power terminals: screw terminals

9 A - Integrated auxiliary contacts 1 NO + 1 NC

| | | | | | |
|---------|-----|------|--------|------|---|
| 4160 80 | 9 A | 25 A | 24 V~ | 1088 | 1 |
| 4160 81 | 9 A | 25 A | 24 V= | 1980 | 1 |
| 4160 82 | 9 A | 25 A | 48 V~ | 1088 | 1 |
| 4160 83 | 9 A | 25 A | 48 V= | 1980 | 1 |
| 4160 84 | 9 A | 25 A | 110 V~ | 1088 | 1 |
| 4160 86 | 9 A | 25 A | 230 V~ | 1088 | 1 |
| 4160 88 | 9 A | 25 A | 380 V~ | 1088 | 1 |
| 4160 89 | 9 A | 25 A | 415 V~ | 1088 | 1 |

* MRP - Maximum Retail Price Inclusive of all taxes including GST.

3 pole contactors CTX³

9 A to 100 A industrial contactors

| Cat.Nos | Max. opt. current AC 3 | Max. opt. current AC 1 | Control voltage | MRP* ₹ / Unit | Pack |
|---------|---------------------------|---------------------------|-----------------|------------------|------|
|---------|---------------------------|---------------------------|-----------------|------------------|------|

12 A - Integrated auxiliary contacts 1 NO + 1 NC

| | | | | | |
|---------|------|------|--------|------|---|
| 4160 90 | 12 A | 25 A | 24 V~ | 1232 | 1 |
| 4160 91 | 12 A | 25 A | 24 V= | 2140 | 1 |
| 4160 92 | 12 A | 25 A | 48 V~ | 1232 | 1 |
| 4160 93 | 12 A | 25 A | 48 V= | 2140 | 1 |
| 4160 94 | 12 A | 25 A | 110 V~ | 1232 | 1 |
| 4160 96 | 12 A | 25 A | 230 V~ | 1232 | 1 |
| 4160 98 | 12 A | 25 A | 380 V~ | 1232 | 1 |
| 4160 99 | 12 A | 25 A | 415 V~ | 1232 | 1 |

18 A - Integrated auxiliary contacts 1 NO + 1 NC

| | | | | | |
|---------|------|------|--------|------|---|
| 4161 00 | 18 A | 40 A | 24 V~ | 1432 | 1 |
| 4161 01 | 18 A | 40 A | 24 V= | 2640 | 1 |
| 4161 02 | 18 A | 40 A | 48 V~ | 1432 | 1 |
| 4161 03 | 18 A | 40 A | 48 V= | 2640 | 1 |
| 4161 04 | 18 A | 40 A | 110 V~ | 1432 | 1 |
| 4161 06 | 18 A | 40 A | 230 V~ | 1432 | 1 |
| 4161 08 | 18 A | 40 A | 380 V~ | 1432 | 1 |
| 4161 09 | 18 A | 40 A | 415 V~ | 1432 | 1 |

22 A - Integrated auxiliary contacts 1 NO + 1 NC

| | | | | | |
|---------|------|------|--------|------|---|
| 4161 10 | 22 A | 40 A | 24 V~ | 1792 | 1 |
| 4161 11 | 22 A | 40 A | 24 V= | 3392 | 1 |
| 4161 12 | 22 A | 40 A | 48 V~ | 1792 | 1 |
| 4161 13 | 22 A | 40 A | 48 V= | 3392 | 1 |
| 4161 14 | 22 A | 40 A | 110 V~ | 1792 | 1 |
| 4161 16 | 22 A | 40 A | 230 V~ | 1792 | 1 |
| 4161 18 | 22 A | 40 A | 380 V~ | 1792 | 1 |
| 4161 19 | 22 A | 40 A | 415 V~ | 1792 | 1 |

CTX³ 40

With integrated auxiliary contacts

Power terminals: screw terminals

32 A - Integrated auxiliary contacts 2 NO + 2 NC

| | | | | | |
|---------|------|------|--------|------|---|
| 4161 20 | 32 A | 50 A | 24 V~ | 3716 | 1 |
| 4161 21 | 32 A | 50 A | 24 V= | 7328 | 1 |
| 4161 22 | 32 A | 50 A | 48 V~ | 3716 | 1 |
| 4161 23 | 32 A | 50 A | 48 V= | 7328 | 1 |
| 4161 24 | 32 A | 50 A | 110 V~ | 3716 | 1 |
| 4161 26 | 32 A | 50 A | 230 V~ | 3716 | 1 |
| 4161 28 | 32 A | 50 A | 380 V~ | 3716 | 1 |
| 4161 29 | 32 A | 50 A | 415 V~ | 3716 | 1 |

40 A - Integrated auxiliary contacts 2 NO + 2 NC

| | | | | | |
|---------|------|------|--------|------|---|
| 4161 30 | 40 A | 60 A | 24 V~ | 5514 | 1 |
| 4161 31 | 40 A | 60 A | 24 V= | 9272 | 1 |
| 4161 32 | 40 A | 60 A | 48 V~ | 5514 | 1 |
| 4161 33 | 40 A | 60 A | 48 V= | 9272 | 1 |
| 4161 34 | 40 A | 60 A | 110 V~ | 5514 | 1 |
| 4161 36 | 40 A | 60 A | 230 V~ | 5514 | 1 |
| 4161 38 | 40 A | 60 A | 380 V~ | 5514 | 1 |
| 4161 39 | 40 A | 60 A | 415 V~ | 5514 | 1 |

CTX³ 65

With integrated auxiliary contacts

50 A - Integrated auxiliary contacts 2 NO + 2 NC

Screw terminals

| | | | | | |
|---------|------|------|--------|-------|---|
| 4161 40 | 50 A | 70 A | 24 V~ | 6752 | 1 |
| 4161 41 | 50 A | 70 A | 24 V= | 11206 | 1 |
| 4161 42 | 50 A | 70 A | 48 V~ | 6752 | 1 |
| 4161 43 | 50 A | 70 A | 48 V= | 11206 | 1 |
| 4161 44 | 50 A | 70 A | 110 V~ | 6752 | 1 |
| 4161 46 | 50 A | 70 A | 230 V~ | 6752 | 1 |
| 4161 48 | 50 A | 70 A | 380 V~ | 6752 | 1 |
| 4161 49 | 50 A | 70 A | 415 V~ | 6752 | 1 |

Bold Cat.Nos are products normally available with Legrand (India) Stockists. Cat.Nos that are not bold - delivery within 4 - 8 weeks from the date of order. Bold packing quantity is our mandatory packing. Orders to be placed by Legrand (India) Stockist in multiples of the same.



4171 55



4160 96



4161 26



4161 46

3 pole contactors CTX³ 9 A to 100 A industrial contactors

| Cat.Nos | Max. opt. current AC 3 | Max. opt. current AC 1 | Control voltage | MRP* ₹ / Unit | Pack |
|---|------------------------|------------------------|-----------------|---------------|------|
| 65 A - Integrated auxiliary contacts 2 NO + 2 NC Screw terminals | | | | | |
| 4161 60 | 65 A | 100 A | 24 V~ | 9058 | 1 |
| 4161 61 | 65 A | 100 A | 24 V= | 12586 | 1 |
| 4161 62 | 65 A | 100 A | 48 V~ | 9058 | 1 |
| 4161 63 | 65 A | 100 A | 48 V= | 12586 | 1 |
| 4161 64 | 65 A | 100 A | 110 V~ | 9058 | 1 |
| 4161 66 | 65 A | 100 A | 230 V~ | 9058 | 1 |
| 4161 68 | 65 A | 100 A | 380 V~ | 9058 | 1 |
| 4161 69 | 65 A | 100 A | 415 V~ | 9058 | 1 |

CTX³ 100

With integrated auxiliary contacts

75 A - Integrated auxiliary contacts 2 NO + 2 NC Screw terminals

| | | | | | |
|---------|------|-------|--------|-------|---|
| 4161 80 | 75 A | 110 A | 24 V~ | 11242 | 1 |
| 4161 81 | 75 A | 110 A | 24 V= | 14764 | 1 |
| 4161 82 | 75 A | 110 A | 48 V~ | 11242 | 1 |
| 4161 83 | 75 A | 110 A | 48 V= | 14764 | 1 |
| 4161 84 | 75 A | 110 A | 110 V~ | 11242 | 1 |
| 4161 86 | 75 A | 110 A | 230 V~ | 11242 | 1 |
| 4161 88 | 75 A | 110 A | 380 V~ | 11242 | 1 |
| 4161 89 | 75 A | 110 A | 415 V~ | 11242 | 1 |

85 A - Integrated auxiliary contacts 2 NO + 2 NC Screw terminals

| | | | | | |
|---------|------|-------|--------|-------|---|
| 4162 00 | 85 A | 135 A | 24 V~ | 11640 | 1 |
| 4162 01 | 85 A | 135 A | 24 V= | 15618 | 1 |
| 4162 02 | 85 A | 135 A | 48 V~ | 11640 | 1 |
| 4162 03 | 85 A | 135 A | 48 V= | 15618 | 1 |
| 4162 04 | 85 A | 135 A | 110 V~ | 11640 | 1 |
| 4162 06 | 85 A | 135 A | 230 V~ | 11640 | 1 |
| 4162 08 | 85 A | 135 A | 380 V~ | 11640 | 1 |
| 4162 09 | 85 A | 135 A | 415 V~ | 11640 | 1 |

100 A - Integrated auxiliary contacts 2 NO + 2 NC Screw terminals

| | | | | | |
|---------|-------|-------|--------|-------|---|
| 4162 20 | 100 A | 160 A | 24 V~ | 14238 | 1 |
| 4162 21 | 100 A | 160 A | 24 V= | 19092 | 1 |
| 4162 22 | 100 A | 160 A | 48 V~ | 14238 | 1 |
| 4162 23 | 100 A | 160 A | 48 V= | 19092 | 1 |
| 4162 24 | 100 A | 160 A | 110 V~ | 14238 | 1 |
| 4162 26 | 100 A | 160 A | 230 V~ | 14238 | 1 |
| 4162 28 | 100 A | 160 A | 380 V~ | 14238 | 1 |
| 4162 29 | 100 A | 160 A | 415 V~ | 14238 | 1 |

3 pole contactors CTX³ 130 A to 800 A industrial contactors

CTX 150

With integrated auxiliary contacts

130 A - Integrated auxiliary contacts 2 NO + 2 NC Screw terminals

| | | | | | |
|---------|-------|-------|----------------------------|-------|---|
| 4162 40 | 130 A | 160 A | 24 V~ | 21776 | 1 |
| 4162 41 | 130 A | 160 A | 24 V= | 27734 | 1 |
| 4162 42 | 130 A | 160 A | 48 V~ | 21776 | 1 |
| 4162 43 | 130 A | 160 A | 48 V= | 27734 | 1 |
| 4162 46 | 130 A | 160 A | 100-240 VA/= 400-440 V~ | 21776 | 1 |
| 4162 49 | 130 A | 160 A | 400-440 V~ | 21776 | 1 |

150 A - Integrated auxiliary contacts 2 NO + 2 NC Screw terminals

| | | | | | |
|---------|-------|-------|-------|-------|---|
| 4162 60 | 150 A | 210 A | 24 V~ | 22278 | 1 |
| 4162 61 | 150 A | 210 A | 24 V= | 26498 | 1 |
| 4162 62 | 150 A | 210 A | 48 V~ | 22278 | 1 |
| 4162 63 | 150 A | 210 A | 48 V= | 26498 | 1 |

* MRP - Maximum Retail Price Inclusive of all taxes including GST.

3 pole contactors CTX³ 130 A to 800 A industrial contactors

| Cat.Nos | Max. opt. current AC 3 | Max. opt. current AC 1 | Control voltage | MRP* ₹ / Unit | Pack |
|--|------------------------|------------------------|-----------------|---------------|------|
| 150 A - Integrated auxiliary contacts 2 NO + 2 NC Screw terminals | | | | | |
| 4162 66 | 150 A | 210 A | 100-240 V~/= | 22278 | 1 |
| 4162 69 | 150 A | 210 A | 400-440 V~ | 22278 | 1 |

CTX³ 225

With integrated auxiliary contacts - Screw terminals

185 A - Integrated auxiliary contacts 2 NO + 2 NC

| | | | | | |
|---------|-------|-------|--------------|-------|---|
| 4162 80 | 185 A | 230 A | 24 V~/= | 32918 | 1 |
| 4162 82 | 185 A | 230 A | 48 V~/= | 32918 | 1 |
| 4162 86 | 185 A | 230 A | 100-240 V~/= | 25840 | 1 |
| 4162 89 | 185 A | 230 A | 380-450 V~ | 25840 | 1 |

225 A - Integrated auxiliary contacts 2 NO + 2 NC

| | | | | | |
|---------|-------|-------|--------------|-------|---|
| 4162 90 | 225 A | 275 A | 24 V~/= | 35858 | 1 |
| 4162 92 | 225 A | 275 A | 48 V~/= | 35858 | 1 |
| 4162 96 | 225 A | 275 A | 100-240 V~/= | 29246 | 1 |
| 4162 99 | 225 A | 275 A | 380-450 V~ | 29246 | 1 |

CTX³ 400

With integrated auxiliary contacts - Screw terminals

265 A - Integrated auxiliary contacts 2 NO + 2 NC

| | | | | | |
|---------|-------|-------|-------------|-------|---|
| 4163 06 | 265 A | 300 A | 100-40 V~/= | 34970 | 1 |
| 4163 09 | 265 A | 300 A | 380-450 V~ | 34970 | 1 |

330 A - Integrated auxiliary contacts 2 NO + 2 NC

| | | | | | |
|---------|-------|-------|-------------|-------|---|
| 4163 16 | 330 A | 350 A | 110-40 V~/= | 39992 | 1 |
| 4163 19 | 330 A | 350 A | 380-450 V~ | 39992 | 1 |

400 A - Integrated auxiliary contacts 2 NO + 2 NC

| | | | | | |
|---------|-------|-------|-------------|-------|---|
| 4163 26 | 400 A | 450 A | 110-40 V~/= | 48468 | 1 |
| 4163 29 | 400 A | 450 A | 380-450 V~ | 48468 | 1 |

CTX³ 800

With integrated auxiliary contacts - Screw terminals

500 A - Integrated auxiliary contacts 2 NO + 2 NC

| | | | | | |
|---------|-------|-------|-------------|-------|---|
| 4163 36 | 500 A | 580 A | 200-40 V~/= | 72136 | 1 |
| 4163 39 | 500 A | 580 A | 380-450 V~ | 72136 | 1 |

630 A - Integrated auxiliary contacts 2 NO + 2 NC

| | | | | | |
|---------|-------|-------|-------------|--------|---|
| 4163 46 | 630 A | 660 A | 200-40 V~/= | 102720 | 1 |
| 4163 49 | 630 A | 660 A | 380-450 V~ | 102720 | 1 |

800 A - Integrated auxiliary contacts 2 NO + 2 NC

| | | | | | |
|---------|-------|-------|-------------|--------|---|
| 4163 56 | 800A | 900 A | 200-40 V~/= | 156128 | 1 |
| 4163 59 | 800 A | 900 A | 380-450 V~ | 156128 | 1 |

Bold Cat.Nos are products normally available with Legrand (India) Stockists. Cat.Nos that are not bold - delivery within 4 - 8 weeks from the date of order. Bold packing quantity is our mandatory packing. Orders to be placed by Legrand (India) Stockist in multiples of the same.



4161 86



4162 96



4162 46



4163 56

Thermal relays RTX³

for CTX³ 3 pole industrial contactors

| Cat.Nos | I min. (A) | I max. (A) | MRP* ₹ / Unit | Pack |
|---------|---------------|---------------|---------------------|------|
|---------|---------------|---------------|---------------------|------|

Features

Conforms to IEC/EN 60947-4-1
CE & UL Certified
Thermal protection of circuits against overload, long starting times, and phase failure
Trip Class 10A
Trip Indication
Manual/Automatic Reset

Integrated auxiliary contacts 1 NO & 1 NC

Standard type:
- Overload detecting bimetal is used all for three phases
Differential type:
- Standard type characteristics + phase failure protection

Thermal overload relays

Class 10A - Integrated auxiliary contacts 1 NO + 1 NC

RTX³ 40 - for CTX³ 22 and 40
Standard type with screw terminals

| | | | | |
|---------|------|------|------|---|
| 4166 40 | 0.1 | 0.16 | 1522 | 1 |
| 4166 41 | 0.16 | 0.25 | 1522 | 1 |
| 4166 42 | 0.25 | 0.4 | 1522 | 1 |
| 4166 43 | 0.4 | 0.63 | 1522 | 1 |
| 4166 44 | 0.63 | 1 | 1522 | 1 |
| 4166 45 | 1 | 1.6 | 1522 | 1 |
| 4166 46 | 1.6 | 2.5 | 1522 | 1 |
| 4166 47 | 2.5 | 4 | 1522 | 1 |
| 4166 48 | 4 | 6 | 1522 | 1 |
| 4166 49 | 5 | 8 | 1522 | 1 |

RTX³ 40 - for CTX³ 22 and 40
Standard type with screw terminals

| | | | | |
|---------|----|----|------|---|
| 4166 50 | 6 | 9 | 1522 | 1 |
| 4166 51 | 7 | 10 | 1522 | 1 |
| 4166 52 | 9 | 13 | 1522 | 1 |
| 4166 53 | 12 | 18 | 1522 | 1 |
| 4166 54 | 16 | 22 | 1626 | 1 |
| 4166 55 | 18 | 25 | 1642 | 1 |
| 4166 56 | 22 | 32 | 1866 | 1 |
| 4166 57 | 28 | 40 | 2008 | 1 |

RTX³ 40 - for CTX³ 22 and 40
Differential type with screw terminals

| | | | | |
|---------|------|------|------|---|
| 4166 60 | 0.1 | 0.16 | 1858 | 1 |
| 4166 61 | 0.16 | 0.25 | 1858 | 1 |
| 4166 62 | 0.25 | 0.4 | 1858 | 1 |
| 4166 63 | 0.4 | 0.63 | 1874 | 1 |
| 4166 64 | 0.63 | 1 | 1874 | 1 |
| 4166 65 | 1 | 1.6 | 1874 | 1 |
| 4166 66 | 1.6 | 2.5 | 1874 | 1 |
| 4166 67 | 2.5 | 4 | 1874 | 1 |
| 4166 68 | 4 | 6 | 1884 | 1 |
| 4166 69 | 5 | 8 | 1884 | 1 |
| 4166 70 | 6 | 9 | 1884 | 1 |
| 4166 71 | 7 | 10 | 1884 | 1 |
| 4166 72 | 9 | 13 | 1884 | 1 |
| 4166 73 | 12 | 18 | 1970 | 1 |
| 4166 74 | 16 | 22 | 1970 | 1 |
| 4166 75 | 18 | 25 | 1970 | 1 |
| 4166 76 | 22 | 32 | 2280 | 1 |
| 4166 77 | 28 | 40 | 2280 | 1 |

RTX³ 65 - for CTX³ 65
Standard type with screw terminals

| | | | | |
|---------|----|----|------|---|
| 4166 83 | 9 | 13 | 3058 | 1 |
| 4166 84 | 12 | 18 | 3058 | 1 |
| 4166 85 | 16 | 22 | 3058 | 1 |
| 4166 86 | 18 | 25 | 3058 | 1 |
| 4166 87 | 24 | 36 | 3058 | 1 |
| 4166 88 | 28 | 40 | 3058 | 1 |
| 4166 89 | 34 | 50 | 3058 | 1 |
| 4166 90 | 45 | 65 | 3058 | 1 |

* MRP - Maximum Retail Price Inclusive of all taxes including GST.

Thermal relays RTX³

for CTX³ 3 pole industrial contactors

| Cat.Nos | I min. (A) | I max. (A) | MRP* ₹ / Unit | Pack |
|---------|---------------|---------------|---------------------|------|
|---------|---------------|---------------|---------------------|------|

RTX³ 65 - for CTX³ 65

Differential type with screw terminals

| | | | | |
|---------|----|----|------|---|
| 4167 03 | 9 | 13 | 3668 | 1 |
| 4167 04 | 12 | 18 | 3668 | 1 |
| 4167 05 | 16 | 22 | 3668 | 1 |
| 4167 06 | 18 | 25 | 3668 | 1 |
| 4167 07 | 24 | 36 | 3668 | 1 |
| 4167 08 | 28 | 40 | 3668 | 1 |
| 4167 09 | 34 | 50 | 3668 | 1 |
| 4167 10 | 45 | 65 | 3668 | 1 |

RTX³ 100 - for CTX³ 100

Standard type with screw terminals

| | | | | |
|---------|----|-----|------|---|
| 4167 23 | 18 | 25 | 4774 | 1 |
| 4167 24 | 24 | 36 | 4910 | 1 |
| 4167 25 | 28 | 40 | 4910 | 1 |
| 4167 26 | 34 | 50 | 4910 | 1 |
| 4167 27 | 45 | 65 | 4910 | 1 |
| 4167 28 | 54 | 75 | 4910 | 1 |
| 4167 29 | 63 | 85 | 4910 | 1 |
| 4167 30 | 70 | 95 | 4910 | 1 |
| 4167 31 | 80 | 100 | 4910 | 1 |

RTX³ 100 - for CTX³ 100

Differential type with screw terminals

| | | | | |
|---------|----|-----|------|---|
| 4167 43 | 18 | 25 | 5890 | 1 |
| 4167 44 | 24 | 36 | 5890 | 1 |
| 4167 45 | 28 | 40 | 6818 | 1 |
| 4167 46 | 34 | 50 | 6818 | 1 |
| 4167 47 | 45 | 65 | 6818 | 1 |
| 4167 48 | 54 | 75 | 6818 | 1 |
| 4167 49 | 63 | 85 | 6818 | 1 |
| 4167 50 | 70 | 95 | 6818 | 1 |
| 4167 51 | 80 | 100 | 6818 | 1 |

RTX³ 150 - for CTX³ 150

Standard type with screw terminals

| | | | | |
|---------|-----|-----|------|---|
| 4167 60 | 45 | 65 | 7222 | 1 |
| 4167 61 | 54 | 75 | 7222 | 1 |
| 4167 62 | 63 | 85 | 7222 | 1 |
| 4167 63 | 80 | 105 | 7222 | 1 |
| 4167 64 | 95 | 130 | 7222 | 1 |
| 4167 65 | 110 | 150 | 7222 | 1 |

RTX³ 150 - for CTX³ 150

Differential type with screw terminals

| | | | | |
|---------|-----|-----|------|---|
| 4167 70 | 45 | 65 | 8834 | 1 |
| 4167 71 | 54 | 75 | 8834 | 1 |
| 4167 72 | 63 | 85 | 8834 | 1 |
| 4167 73 | 80 | 105 | 8834 | 1 |
| 4167 74 | 95 | 130 | 8834 | 1 |
| 4167 75 | 110 | 150 | 8834 | 1 |

NEW!



4167 31

NEW!



4167 65

NEW!

Bold Cat.Nos are products normally available with Legrand (India) Stockists. Cat.Nos that are not bold - delivery within 4 - 8 weeks from the date of order. Bold packing quantity is our mandatory packing. Orders to be placed by Legrand (India) Stockist in multiples of the same.

Thermal relays RTX³

for CTX³ 3 pole industrial contactors

| Cat.Nos | Description | MRP* ₹ / Unit | Pack |
|---------|-------------|------------------|------|
|---------|-------------|------------------|------|

Separate mounting units

To mount the relays separately from contactors, on DIN rail or panel by fixing screws

| | | | |
|---------|---|------|---|
| 4165 91 | For RTX ³ 40 up to 32 A | 560 | 1 |
| 4165 92 | For RTX ³ 40 40 A | 560 | 1 |
| 4165 93 | For RTX ³ 65 with screw terminals | 692 | 1 |
| 4165 94 | For RTX ³ 65 with cage terminals | 692 | 1 |
| 4165 95 | For RTX ³ 100 with screw terminals | 878 | 1 |
| 4165 96 | For RTX ³ 100 with cage terminals | 878 | 1 |
| 4165 97 | For RTX ³ 150 with screw terminals | 1386 | 1 |
| 4165 98 | For RTX ³ 150 with cage terminals | 1386 | 1 |

Thermal overload relays

Class 10 A - Integrated auxiliary contacts 1 NO + 1 NC

| Cat.Nos | I min. (A) | I max. (A) | MRP* ₹ / Unit | Pack |
|---------|------------|------------|------------------|------|
|---------|------------|------------|------------------|------|

RTX³ 225 - for CTX³ 225

Differential type with screw terminals

| | | | | |
|---------|-----|-----|-------|---|
| 4167 80 | 65 | 100 | 10834 | 1 |
| 4167 81 | 85 | 125 | 10834 | 1 |
| 4167 82 | 100 | 160 | 11202 | 1 |
| 4167 83 | 120 | 185 | 11202 | 1 |
| 4167 84 | 160 | 240 | 11202 | 1 |



4167 84

RTX³ 400 - for CTX³ 400

Differential type with screw terminals

| | | | | |
|---------|-----|-----|-------|---|
| 4167 86 | 85 | 125 | 13772 | 1 |
| 4167 87 | 100 | 160 | 13772 | 1 |
| 4167 88 | 120 | 185 | 13772 | 1 |
| 4167 89 | 160 | 240 | 13772 | 1 |
| 4167 90 | 200 | 330 | 13772 | 1 |
| 4167 91 | 260 | 400 | 13772 | 1 |



4167 91

RTX³ 800 - for CTX³ 800

Differential type with screw terminals

| | | | | |
|---------|-----|-----|-------|---|
| 4167 92 | 200 | 300 | 21420 | 1 |
| 4167 93 | 260 | 400 | 21420 | 1 |
| 4167 94 | 400 | 630 | 21420 | 1 |
| 4167 95 | 520 | 800 | 21420 | 1 |



4164 36

4-pole contactors CTX³

40 A to 900 A industrial contactors and spare coils

| Cat.Nos | Max. opt. current AC 1 | Max. opt. current AC 3 | Control voltage | MRP* ₹ / Unit | Pack |
|---------|------------------------|------------------------|-----------------|------------------|------|
|---------|------------------------|------------------------|-----------------|------------------|------|

Contactors CTX³

Power terminals: screw terminals

Without integrated auxiliary contact

| | | | | | |
|---------|-------|------|--------|-------|---|
| 4164 26 | 40 A | 22 A | 230 V~ | 2500 | 1 |
| 4164 36 | 60 A | 40 A | 230 V~ | 6344 | 1 |
| 4164 46 | 100 A | 65 A | 230 V~ | 10284 | 1 |
| 4164 56 | 135 A | 85 A | 230 V~ | 13146 | 1 |



4164 56

* MRP - Maximum Retail Price Inclusive of all taxes including GST.

4-pole contactors CTX³

40 A to 900 A industrial contactors and spare coils

| Cat.Nos | Max. opt. current AC 1 | Max. opt. current AC 3 | Control voltage | MRP* ₹ / Unit | Pack |
|---------|------------------------|------------------------|-----------------|------------------|------|
|---------|------------------------|------------------------|-----------------|------------------|------|

With integrated auxiliary contacts

Auxiliary contacts: 2 NO + 2 NC

| | | | | | |
|---------|-------|-------|--------------|--------|---|
| 4164 66 | 165 A | 130 A | 100-240 V~/= | 21362 | 1 |
| 4164 76 | 250 A | 150 A | 100-240 V~/= | 27632 | 1 |
| 4164 86 | 330 A | 225 A | 100-240 V~/= | 31942 | 1 |
| 4164 96 | 420 A | 330 A | 100-240 V~/= | 56866 | 1 |
| 4165 06 | 500 A | 400 A | 100-240 V~/= | 61068 | 1 |
| 4165 16 | 750 A | 630 A | 200-240 V~/= | 127482 | 1 |
| 4165 26 | 900 A | 800 A | 200-240 V~/= | 147046 | 1 |



4164 86

Spare coils for CTX³ 4P contactors

| Cat.Nos | Description | MRP* ₹ / Unit | Pack |
|---------|-------------|------------------|------|
|---------|-------------|------------------|------|

Control voltage 230 V~

| | | | |
|---------|--|-------|---|
| 4165 46 | For CTX ³ 40 A to 60 A (AC-1) | 1250 | 1 |
| 4165 56 | For CTX ³ 100 A to 135 A (AC-1) | 1376 | 1 |
| 4165 66 | For CTX ³ 165 A to 330 A (AC-1) | 7810 | 1 |
| 4165 76 | For CTX ³ 420 A to 500 A (AC-1) | 14578 | 1 |
| 4165 86 | For CTX ³ 750 A to 900 A (AC-1) | 21866 | 1 |

CTX³ add-on auxiliary contact blocks

Front mounting

For CTX³ 3P form 9 A to 150 A (AC-3) and CTX³ 4P from 40 A to 135 A (AC-1) - 2 and 4 pole - lth: 16 A

| | | | |
|---------|-------------|-----|----|
| 4168 50 | 1 NO + 1 NC | 362 | 10 |
| 4168 51 | 2 NO | 362 | 10 |
| 4168 52 | 2 NC | 362 | 10 |
| 4168 53 | 4 NO | 574 | 10 |
| 4168 54 | 3 NO + 1 NC | 574 | 10 |
| 4168 55 | 2 NO + 2 NC | 574 | 10 |
| 4168 56 | 1 NO + 3 NC | 574 | 10 |
| 4168 57 | 4 NC | 574 | 10 |



4168 50



4168 55

Side mounting

2 pole - Mounting on both sides

| | | | |
|---------|---|-----|----|
| 4168 58 | For CTX ³ 3P Form 9 A to 150 A (AC-3) 1 NO + 1 NC - lth: 16 A | 636 | 10 |
| 4168 59 | For CTX ³ 3P Form 185 A to 800 A (AC-3) and CTX ³ 4P from 165 A to 900 A (AC-1) 1 NO + 1 NC - lth: 16 A | 636 | 10 |
| 4168 49 | For CTX ³ 4P From 40 A to 135 A (AC-1) 1 NO + 1 NC - lth: 16 A | 630 | 10 |

Bold Cat.Nos are products normally available with Legrand (India) Stockists. Cat.Nos that are not bold - delivery within 4 - 8 weeks from the date of order. Bold packing quantity is our mandatory packing. Orders to be placed by Legrand (India) Stockist in multiples of the same.

4-pole contactors CTX³

40 A to 900 A industrial contactors and spare coils



| Cat.Nos | Description | MRP* ₹ / Unit | Pack |
|---------|-------------|------------------|------|
|---------|-------------|------------------|------|

CTX³ time delay blocks

For CTX³ 3P from 9 A to 150 A (AC-3)

Time delay: 1 to 30 s

Front mounting

On delay

| | | | |
|---------|-------------------|------|---|
| 4168 70 | 24-48 V \sim /= | 1752 | 1 |
| 4168 71 | 110-230 V \sim | 1752 | 1 |

Off delay

| | | | |
|---------|-------------------|------|---|
| 4168 72 | 24-48 V \sim /= | 2406 | 1 |
| 4168 73 | 110-230 V \sim | 2406 | 1 |

CTX³

capacitor switching units Cat.Nos 4168 74/75/76/77

Capacitor unit is connected to the terminals of the contactor to reduce the high inrush current.

IEC 60947-4-1 AC 6b

| Type | Contactor | | Maximum operating power (kVA) | | | Max. Peak current (A) |
|---|----------------------|-------|-------------------------------|-------------|-------------|-----------------------|
| | | | 220 - 240 V | 400 - 480 V | 500 - 550 V | |
| 4168 74 | CTX ³ 22 | 9 A | 5 | 9.7 | 14 | 560 |
| | CTX ³ 22 | 12 A | 6.7 | 12.5 | 18 | 560 |
| | CTX ³ 22 | 18 A | 8.5 | 16.7 | 24 | 850 |
| | CTX ³ 22 | 22 A | 10 | 18 | 26 | 1250 |
| | CTX ³ 40 | 32 A | 15 | 25 | 36 | 1900 |
| | CTX ³ 40 | 40 A | 20 | 33.3 | 48 | 2160 |
| 4168 75/76 | CTX ³ 65 | 50 A | 20 | 40 | 58 | 2160 |
| | CTX ³ 65 | 65 A | 25 | 45.7 | 66 | 3040 |
| 4168 77 | CTX ³ 100 | 75 A | 29.7 | 54 | 78 | 3040 |
| | CTX ³ 100 | 85 A | 35 | 60 | 92 | 3040 |
| | CTX ³ 100 | 100 A | 37 | 62 | 94 | 3040 |
| Without Capacitor Switching Unit as per IEC 60947-4-1 AC 6b | CTX ³ 150 | 150 A | | 70 | | 3300 |
| | CTX ³ 225 | 185 A | | 84 | 120 | 3500 |
| | CTX ³ 225 | 225 A | | 115 | 130 | 4000 |
| | CTX ³ 400 | 265 A | | 125 | 140 | 5000 |
| | CTX ³ 400 | 330 A | | 139 | 185 | 6500 |
| | CTX ³ 400 | 400 A | | 185 | 195 | 8000 |
| | CTX ³ 800 | 500 A | | 220 | 330 | 10000 |
| | CTX ³ 800 | 630 A | | 291 | 340 | 12000 |
| | CTX ³ 800 | 800 A | | 369 | 370 | 14200 |

Note:

- When the switch is closed capacitor must be discharged before recharged. (Maximum residual voltage at terminals \leq 50 V)
- To prevent short current, gG type fuse must be 1.5 - 2 times than rated current

CTX³ accessories

CTX³ capacitor switching units

AC-6b

Operating power from 9.7 kVAR to 62 kVAR (400/440 V)

| | | | |
|---------|---|------|---|
| 4168 74 | For contactors CTX ³ 3P from 9 to 40 A, upto 33.3 kVA at 440 V / 48 kVA at 525 V | 1734 | 1 |
|---------|---|------|---|

* MRP - Maximum Retail Price Inclusive of all taxes including GST.

CTX³ accessories

| Cat.Nos | Description | MRP* ₹ / Unit | Pack |
|---------|-------------|------------------|------|
|---------|-------------|------------------|------|

CTX³ capacitor switching units

| | | | |
|---------|--|------|---|
| 4168 75 | For contactors CTX ³ 3P 50 and 65 A with screw terminals upto 45.7 kVA at 440 V / 66 kVA at 525 V | 2406 | 1 |
| 4168 76 | For contactors CTX ³ 3P 50 and 65 A with cage terminals upto 45.7 kVA at 440 V / 66 kVA at 525 V | 2602 | 1 |
| 4168 77 | For contactors CTX ³ 3P 75 to 100 A with screw terminals upto 62 kVA at 440 V / 94 kVA at 525 V | 2602 | 1 |

CTX³ interlocking

Component parts for assembling by customer

Horizontal mounting

Interlock units

| | | | |
|---------|---|-----|---|
| 4168 79 | Mechanical interlocks for CTX ³ 4P from 40 to 135 A (AC-1) | 966 | 5 |
|---------|---|-----|---|

Interlock units

| | | | |
|---------|---|------|---|
| 4168 80 | Mechanical interlocks for CTX ³ 3P from 9 to 150 A Provides 2 NC contacts for use in electrical interlocking | 1948 | 1 |
| 4168 87 | Mechanical interlocks for CTX ³ 3P from 185 to 400 A and CTX ³ 4P from 165 to 500 A | 3504 | 1 |

Interlock units

| | | | |
|---------|---|------|---|
| 4168 88 | Mechanical interlocks for CTX ³ 3P from 500 to 800 A | 3826 | 1 |
| 4168 89 | Mechanical interlocks for CTX ³ 4P from 750 to 900 A | 4038 | 1 |

Wire kits

Used for making reversing between two 3P contactors

| | | | |
|---------|--------------------------|------|---|
| 4168 82 | For CTX ³ 22 | 1020 | 5 |
| 4168 83 | For CTX ³ 40 | 1380 | 5 |
| 4168 84 | For CTX ³ 65 | 1700 | 5 |
| 4168 85 | For CTX ³ 100 | 2848 | 5 |

Bold Cat.Nos are products normally available with Legrand (India) Stockists. Cat.Nos that are not bold - delivery within 4 - 8 weeks from the date of order. Bold packing quantity is our mandatory packing. Orders to be placed by Legrand (India) Stockist in multiples of the same.

CTX³ accessories



4168 91



4168 97



4168 40

| Cat.Nos | Description | MRP* ₹ / Unit | Pack |
|---------|-------------|---------------------|------|
|---------|-------------|---------------------|------|

Boxes for motor starter

For CTX³ 22 equipped with RTX³ 40 (0.1 - 22 A)

| | | | |
|---------|---------------------|------|---|
| 4168 90 | Without pushbuttons | 2598 | 1 |
| 4168 91 | With pushbuttons | 3184 | 1 |

CTX³ transient voltage suppressor blocks

Absorbs the surge arisen out of the coil of the contactor

| | | | |
|---------|---------------------------|-----|----|
| 4168 95 | 24-48 V \sim / \neq | 520 | 10 |
| 4168 96 | 100-125 V \sim / \neq | 520 | 10 |
| 4168 97 | 200-240 V \sim / \neq | 520 | 10 |
| 4168 98 | 380-400 V \sim | 520 | 10 |

CTX³ terminals covers

| | | | |
|---------|--|------|---|
| 4168 42 | For CTX ³ 3P from 185 to 225 A (AC-3) | 458 | 5 |
| 4168 43 | For CTX ³ 3P from 265 to 400 A (AC-3) | 684 | 5 |
| 4168 44 | For CTX ³ 3P from 500 to 900 A (AC-3) | 1028 | 5 |
| 4168 45 | For CTX ³ 4P from 165 to 330 A (AC-1) | 572 | 5 |
| 4168 46 | For CTX ³ 4P from 420 to 500 A (AC-1) | 868 | 5 |
| 4168 47 | For CTX ³ 4P from 750 to 900 A (AC-1) | 1462 | 5 |

CTX³ safety front cover

| | | | |
|---------|--|-----|----|
| 4168 40 | For CTX ³ 3P from 9 to 150 A (AC-3) and CTX ³ 4P from 40 to 135 A (AC-1) | 30 | 50 |
| 4168 41 | For CTX ³ 3P from 85 to 800 A (AC-3) and CTX 4P from 165 to 900 A (AC-1) | 114 | 50 |

Distant reset flexible cables for thermal relays

| | | | |
|---------|--------|-----|---|
| 4168 92 | 400 mm | 812 | 1 |
| 4168 93 | 500 mm | 882 | 1 |
| 4168 94 | 600 mm | 896 | 1 |

CTX³ spare coils

Spare coils for CTX³ 3P contactors

For CTX³ 22

| | | | |
|---------|--------------|-----|---|
| 4169 00 | 24 V \sim | 684 | 5 |
| 4169 02 | 48 V \sim | 684 | 5 |
| 4169 04 | 110 V \sim | 684 | 5 |
| 4169 06 | 230 V \sim | 684 | 5 |
| 4169 08 | 380 V \sim | 684 | 5 |
| 4169 09 | 415 V \sim | 684 | 5 |

CTX³ accessories

| Cat.Nos | Description | MRP* ₹ / Unit | Pack |
|---------|-------------|---------------------|------|
|---------|-------------|---------------------|------|

For CTX³ 40

| | | | |
|---------|--------------|-----|---|
| 4169 20 | 24 V \sim | 684 | 5 |
| 4169 21 | 24 V \neq | 684 | 5 |
| 4169 22 | 48 V \sim | 684 | 5 |
| 4169 23 | 48 V \neq | 684 | 5 |
| 4169 24 | 110 V \sim | 684 | 5 |
| 4169 26 | 230 V \sim | 684 | 5 |
| 4169 28 | 380 V \sim | 684 | 5 |
| 4169 29 | 415 V \sim | 684 | 5 |

For CTX³ 65

| | | | |
|---------|--------------|-----|---|
| 4169 30 | 24 V \sim | 878 | 5 |
| 4169 31 | 24 V \neq | 878 | 5 |
| 4169 32 | 48 V \sim | 878 | 5 |
| 4169 33 | 48 V \neq | 878 | 5 |
| 4169 34 | 110 V \sim | 878 | 5 |
| 4169 36 | 230 V \sim | 878 | 5 |
| 4169 38 | 380 V \sim | 878 | 5 |
| 4169 39 | 415 V \sim | 878 | 5 |

For CTX³ 100

| | | | |
|---------|--------------|------|---|
| 4169 40 | 24 V \sim | 1072 | 3 |
| 4169 41 | 24 V \neq | 1072 | 3 |
| 4169 42 | 48 V \sim | 1072 | 3 |
| 4169 43 | 48 V \neq | 1072 | 3 |
| 4169 44 | 110 V \sim | 1072 | 3 |
| 4169 46 | 230 V \sim | 1072 | 3 |
| 4169 48 | 380 V \sim | 1072 | 3 |
| 4169 49 | 415 V \sim | 1072 | 3 |

For CTX³ 150

| | | | |
|---------|---------------------------|------|---|
| 4169 50 | 24 V \sim | 4862 | 1 |
| 4169 51 | 24 V \neq | 4862 | 1 |
| 4169 52 | 48 V \sim | 4862 | 1 |
| 4169 53 | 48 V \neq | 4862 | 1 |
| 4169 56 | 100-240 V \sim / \neq | 4862 | 1 |
| 4169 59 | 400-440 V \sim | 4862 | 1 |

For CTX³ 225

| | | | |
|---------|---------------------------|------|---|
| 4169 60 | 24 V \sim / \neq | 6276 | 1 |
| 4169 62 | 48 V \sim / \neq | 6276 | 1 |
| 4169 66 | 100-240 V \sim / \neq | 6276 | 1 |
| 4169 69 | 400-440 V \sim | 6276 | 1 |

For CTX³ 400

| | | | |
|---------|---------------------------|-------|---|
| 4169 76 | 100-240 V \sim / \neq | 10568 | 1 |
| 4169 79 | 380-450 V \sim | 10568 | 1 |

For CTX³ 800

| | | | |
|---------|---------------------------|-------|---|
| 4169 86 | 200-240 V \sim / \neq | 21708 | 1 |
| 4169 89 | 380-450 V \sim | 21708 | 1 |

Auxillary Contactor / Control relays CTX³

4 pole

Bold Cat.Nos are products normally available with Legrand (India) Stockists. Cat.Nos that are not bold - delivery within 4 - 8 weeks from the date of order. Bold packing quantity is our mandatory packing. Orders to be placed by Legrand (India) Stockist in multiples of the same.

Auxiliary Contactor / Control relays CTX³

| Cat.Nos | Description | MRP* ₹ / Unit | Pack |
|---------|-------------|------------------|------|
|---------|-------------|------------------|------|

Conform to IEC 60 947-1, IEC 60 947-4-1 and IEC 60 947-5-1 for the auxiliary contacts

CE & UL Certified

Ultra High Ith = 10 A

Ultra Low consumption coil

Click fit accessories

Spare Coils available

RoHS Compliant

CTX³ control relays

4 NO

| | | | |
|---------|--------|------|---|
| 4168 00 | 24 V~ | 1276 | 1 |
| 4168 01 | 24 V= | 1990 | 1 |
| 4168 02 | 48 V~ | 1276 | 1 |
| 4168 03 | 48 V= | 1990 | 1 |
| 4168 04 | 110 V~ | 1276 | 1 |
| 4168 06 | 230 V~ | 1276 | 1 |
| 4168 09 | 415 V~ | 1276 | 1 |

3 NO + 1 NC

| | | | |
|---------|--------|------|---|
| 4168 10 | 24 V~ | 1276 | 1 |
| 4168 11 | 24 V= | 1990 | 1 |
| 4168 12 | 48 V~ | 1276 | 1 |
| 4168 13 | 48 V= | 1990 | 1 |
| 4168 14 | 110 V~ | 1276 | 1 |
| 4168 16 | 230 V~ | 1276 | 1 |
| 4168 19 | 415 V~ | 1276 | 1 |

2 NO + 2 NC

| | | | |
|---------|--------|------|---|
| 4168 20 | 24 V~ | 1276 | 1 |
| 4168 21 | 24 V= | 1990 | 1 |
| 4168 22 | 48 V~ | 1276 | 1 |
| 4168 23 | 48 V= | 1990 | 1 |
| 4168 24 | 110 V~ | 1276 | 1 |
| 4168 26 | 230 V~ | 1276 | 1 |
| 4168 29 | 415 V~ | 1276 | 1 |

Accessories for Auxiliary Contactor / Control Relays

| Cat.Nos | Description | MRP* ₹ / Unit | Pack |
|---------|-------------|------------------|------|
|---------|-------------|------------------|------|

High Thermal current - 10 A

Ith : 10 A

Front mounting

| | | | |
|---------|-------------|-----|----|
| 4171 50 | 1 NO + 1 NC | 348 | 10 |
| 4171 51 | 2 NO | 348 | 10 |
| 4171 52 | 2 NC | 348 | 10 |
| 4171 53 | 4 NO | 530 | 10 |
| 4171 54 | 3 NO + 1 NC | 530 | 10 |
| 4171 55 | 2 NO + 2 NC | 530 | 10 |
| 4171 56 | 1 NO + 3 NC | 530 | 10 |
| 4171 57 | 4 NC | 530 | 10 |

Side mounting

| | | | |
|---------|------|-----|----|
| 4171 58 | 1 NO | 348 | 10 |
| 4171 59 | 1 NC | 348 | 10 |

Interlock Unit

| | | | |
|---------|----------------------|-----|---|
| 4171 60 | Mechanical interlock | 556 | 5 |
|---------|----------------------|-----|---|

* MRP - Maximum Retail Price Inclusive of all taxes including GST.

Auxiliary Contactor / Control relays CTX³

| Cat.Nos | Description | MRP* ₹ / Unit | Pack |
|---------|-------------|------------------|------|
|---------|-------------|------------------|------|

Spare coils

| | | | |
|---------|--------|-----|---|
| 4171 70 | 24 V~ | 638 | 5 |
| 4171 71 | 24 V= | 866 | 5 |
| 4171 74 | 110 V~ | 638 | 5 |
| 4171 76 | 230 V~ | 638 | 5 |
| 4171 79 | 415 V~ | 638 | 5 |

MPCBs MPX³

motor protection circuit breakers from 0.16 A to 100 A upto 45 KW

Maximum efficiency in a compact unit

Conform to IEC 60947-1, IEC 60947-2, IEC 60947-4

Adjustable thermal release

Magnetic release 13 le max

High breaking capacity

toggle handle

Fixing on rail or by screw

Wide range of accessories

Undervoltage Release

Shunt Release

Auxiliary Contacts

IP 65 Enclosure

Thermal magnetic MPCBs

Adjustable thermal release Magnetic release 13 le max.

MPX³ 32S - 3P

Standard breaking capacity with toggle handle

Fixing on rail

415 V breaking capacity Icu (kA) - 100

| Cat.Nos | Rated 3Ph Motor (KW) | Thermal release adj. range (A) | Magnetic release operating current (A) | MRP* ₹ / Unit | Pack |
|---------|----------------------|--------------------------------|--|------------------|------|
|---------|----------------------|--------------------------------|--|------------------|------|

| | | | | | |
|---------|-------------|--------------|------|------|---|
| 4173 00 | 0.02 | 0.1 to 0.16 | 2.1 | 3002 | 1 |
| 4173 01 | 0.06 | 0.16 to 0.25 | 3.3 | 3002 | 1 |
| 4173 02 | 0.09 | 0.25 to 0.4 | 5.2 | 3002 | 1 |
| 4173 03 | 0.12 | 0.4 to 0.63 | 8.2 | 3490 | 1 |
| 4173 04 | 0.18 / 0.25 | 0.63 to 1 | 13 | 3490 | 1 |
| 4173 05 | 0.37 / 0.55 | 1 to 1.6 | 20.8 | 3512 | 1 |
| 4173 06 | 0.75 | 1.6 to 2.5 | 32.5 | 3512 | 1 |
| 4173 07 | 1.5 | 2.5 to 4 | 52 | 3634 | 1 |
| 4173 08 | 2.2 | 4 to 6 | 78 | 3618 | 1 |
| 4173 09 | 3 | 5 to 8 | 104 | 3618 | 1 |

415 V breaking capacity Icu (kA) - 50

| | | | | | |
|---------|-----|---------|-----|------|---|
| 4173 10 | 4 | 6 to 10 | 130 | 3618 | 1 |
| 4173 11 | 5.5 | 9 to 13 | 169 | 4102 | 1 |

415 V breaking capacity Icu (kA) - 20

| | | | | | |
|---------|-----|----------|-----|------|---|
| 4173 12 | 7.5 | 11 to 17 | 221 | 4420 | 1 |
|---------|-----|----------|-----|------|---|

415 V breaking capacity Icu (kA) - 15

| | | | | | |
|---------|-----|----------|-----|------|---|
| 4173 13 | 7.5 | 14 to 22 | 286 | 5050 | 1 |
| 4173 14 | 11 | 18 to 26 | 338 | 5050 | 1 |
| 4173 15 | 15 | 22 to 32 | 416 | 8312 | 1 |

Bold Cat.Nos are products normally available with Legrand (India) Stockists. Cat.Nos that are not bold - delivery within 4 - 8 weeks from the date of order. Bold packing quantity is our mandatory packing. Orders to be placed by Legrand (India) Stockist in multiples of the same.



4168 10



4173 08

MPCBs MPX³ motor protection circuit breakers from 0.16 A to 100 A upto 45 KW

| Cat.Nos | Rated 3Ph Motor (KW) | Thermal release adj. range (A) | Magnetic release operating current (A) | MRP* ₹ / Unit | Pack |
|---------|----------------------|--------------------------------|--|---------------|------|
|---------|----------------------|--------------------------------|--|---------------|------|

415 V breaking capacity Icu (kA) - 100

| | | | | | |
|---------|-------------|--------------|------|------|---|
| 4173 20 | 0.02 | 0.1 to 0.16 | 2.1 | 3742 | 1 |
| 4173 21 | 0.06 | 0.16 to 0.25 | 3.3 | 3742 | 1 |
| 4173 22 | 0.09 | 0.25 to 0.4 | 5.2 | 3742 | 1 |
| 4173 23 | 0.12 | 0.4 to 0.63 | 8.2 | 4102 | 1 |
| 4173 24 | 0.18 / 0.25 | 0.63 to 1 | 13 | 4102 | 1 |
| 4173 25 | 0.37/ 0.55 | 1 to 1.6 | 20.8 | 4102 | 1 |
| 4173 26 | 0.75 | 1.6 to 2.5 | 32.5 | 4102 | 1 |
| 4173 27 | 1.5 | 2.5 to 4 | 52 | 4230 | 1 |
| 4173 28 | 2.2 | 4 to 6 | 78 | 4208 | 1 |
| 4173 29 | 3 | 5 to 8 | 104 | 4504 | 1 |
| 4173 30 | 4 | 6 to 10 | 130 | 4504 | 1 |
| 4173 31 | 5.5 | 9 to 13 | 169 | 5092 | 1 |



4173 68

415 V breaking capacity Icu (kA) - 50

| | | | | | |
|---------|-----|----------|-----|------|---|
| 4173 32 | 7.5 | 11 to 17 | 221 | 6314 | 1 |
| 4173 33 | 7.5 | 14 to 22 | 286 | 6314 | 1 |
| 4173 34 | 11 | 18 to 26 | 338 | 6314 | 1 |
| 4173 35 | 15 | 22 to 32 | 416 | 9892 | 1 |

MPX³ 63H - 3P

High breaking capacity with rotary handle
Fixing on rail or by screw
415 V breaking capacity Icu (kA) - 100

| | | | | | |
|---------|-----|---------|-----|------|---|
| 4173 60 | 4 | 6 to 10 | 130 | 9604 | 1 |
| 4173 61 | 5.5 | 9 to 13 | 169 | 9604 | 1 |

415 V breaking capacity Icu (kA) - 50

| | | | | | |
|---------|------|----------|-----|-------|---|
| 4173 62 | 7.5 | 11 to 17 | 221 | 9604 | 1 |
| 4173 63 | 7.5 | 14 to 22 | 286 | 10886 | 1 |
| 4173 64 | 11 | 18 to 26 | 338 | 10886 | 1 |
| 4173 65 | 15 | 22 to 32 | 416 | 10886 | 1 |
| 4173 66 | 18.5 | 28 to 40 | 520 | 12166 | 1 |
| 4173 67 | 22 | 34 to 50 | 650 | 14942 | 1 |
| 4173 68 | 30 | 45 to 63 | 819 | 15794 | 1 |

MPX³ 100H - 3P

High breaking capacity with rotary handle
Fixing on rail or by screw
415 V breaking capacity Icu (kA) - 100

| | | | | | |
|---------|------|----------|-----|-------|---|
| 4173 70 | 7.5 | 11 to 17 | 221 | 13276 | 1 |
| 4173 71 | 7.5 | 14 to 22 | 286 | 13276 | 1 |
| 4173 72 | 11 | 18 to 26 | 338 | 13276 | 1 |
| 4173 73 | 15 | 22 to 32 | 416 | 13276 | 1 |
| 4173 74 | 18.5 | 28 to 40 | 520 | 13276 | 1 |
| 4173 75 | 22 | 34 to 50 | 650 | 15778 | 1 |
| 4173 76 | 30 | 45 to 63 | 819 | 16540 | 1 |

415 V breaking capacity Icu (kA) - 75

| | | | | | |
|---------|----|-----------|------|-------|---|
| 4173 77 | 37 | 55 to 75 | 975 | 17784 | 1 |
| 4173 78 | 45 | 70 to 90 | 1170 | 17784 | 1 |
| 4173 79 | 45 | 80 to 100 | 1300 | 17784 | 1 |



4173 79

* MRP - Maximum Retail Price Inclusive of all taxes including GST.

MPCBs MPX³ motor protection circuit breakers from 0.16 A to 100 A upto 45 KW

| Cat.Nos | Rated 3Ph Motor | Magnetic release operating current (A) | MRP* ₹ / Unit | Pack |
|---------|-----------------|--|---------------|------|
|---------|-----------------|--|---------------|------|

Magnetic only MPCBs

Without thermal release
Magnetic release 13 x le max.

MPX³ 32MA - 3P

High breaking capacity with rotary handle
Fixing on rail

415 V breaking capacity Icu (kA) - 100

| | | | | |
|---------|-------------|------|------|---|
| 4173 40 | 0.02 | 2.1 | 3396 | 1 |
| 4173 41 | 0.06 | 3.3 | 3396 | 1 |
| 4173 42 | 0.09 | 5.2 | 3396 | 1 |
| 4173 43 | 0.12 | 8.2 | 3782 | 1 |
| 4173 44 | 0.18 / 0.25 | 13 | 3782 | 1 |
| 4173 45 | 0.37 / 0.55 | 20.8 | 3782 | 1 |
| 4173 46 | 0.75 | 32.5 | 3782 | 1 |
| 4173 47 | 1.5 | 52 | 3826 | 1 |
| 4173 48 | 2.2 | 78 | 3826 | 1 |
| 4173 49 | 3 | 104 | 3826 | 1 |
| 4173 50 | 4 | 130 | 4038 | 1 |
| 4173 51 | 5.5 | 169 | 4290 | 1 |



4173 48

415 V breaking capacity Icu (kA) - 50

| | | | | |
|---------|-----|-----|------|---|
| 4173 52 | 7.5 | 221 | 5522 | 1 |
| 4173 53 | 7.5 | 286 | 5522 | 1 |
| 4173 54 | 11 | 338 | 5522 | 1 |
| 4173 55 | 15 | 416 | 9134 | 1 |

MPCBs MPX³ accessories

| Cat.Nos | Description | MRP* ₹ / Unit | Pack |
|---------|-------------|---------------|------|
|---------|-------------|---------------|------|

Auxiliary contacts

2 pole

Side mounting

Mounting on the left side of MPCBs
Two auxiliary contacts per MPCB

| | | | |
|---------|-------------|-----|---|
| 4174 00 | 1 NO + 1 NC | 726 | 5 |
| 4174 01 | 2 NO | 726 | 5 |
| 4174 02 | 2 NC | 726 | 5 |



4174 00

Front mounting

One auxiliary contact per MPCB

| | | | |
|---------|-------------|-----|---|
| 4174 03 | 1 NO + 1 NC | 748 | 5 |
| 4174 04 | 2 NO | 748 | 5 |
| 4174 05 | 2 NC | 748 | 5 |



4174 03

Alarm contacts

1 NO + 1 NC

Any trip alarm contact

Operates in case of trip

Mounting on the left side of MPCBs

Set alarm contact first in case of using auxiliary contact together (MPX³ 63H can not accept auxiliary contact and alarm contact together)

| | | | |
|---------|---------------------------------|------|---|
| 4174 06 | For MPX ³ 32 | 1172 | 1 |
| 4174 08 | For MPX ³ 63 and 100 | 1172 | 1 |

Magnetic trip alarm contact

Operates in case of instantaneous trip

Mounting on the left side of MPCBs

Set alarm contact first in case of using auxiliary contact together

| | | | |
|---------|-------------|------|---|
| 4174 07 | 1 NO + 1 NC | 1172 | 1 |
|---------|-------------|------|---|

Bold Cat.Nos are products normally available with Legrand (India) Stockists. Cat.Nos that are not bold - delivery within 4 - 8 weeks from the date of order. **Bold packing quantity** is our mandatory packing. Orders to be placed by Legrand (India) Stockist in multiples of the same.

MPCBs MPX³ accessories



4174 12



4174 22

| Cat.Nos | Description | MRP* ₹ / Unit | Pack |
|---------|-------------|------------------|------|
|---------|-------------|------------------|------|

Shunt release

Mounting on the right side of MPCBs
One release per MPCB

| | | | |
|---------|--|------|---|
| 4174 10 | 24 V - 50 Hz / 28 V - 60 Hz | 1864 | 1 |
| 4174 11 | 110 V - 50 Hz / 120 V - 60 Hz | 1864 | 1 |
| 4174 12 | 220-230 V - 50 Hz / 240-260 V - 60 Hz | 1864 | 1 |
| 4174 13 | 380-400 V - 50 Hz / 440-460 V - 60 Hz | 1864 | 1 |

Undervoltage release

Mounting on the right side of MPCBs
One release per MPCB

Without auxiliary contact

| | | | |
|---------|--|------|---|
| 4174 20 | 24 V - 50 Hz / 28 V - 60 Hz | 1864 | 1 |
| 4174 21 | 110 V - 50 Hz / 120 V - 60 Hz | 1864 | 1 |
| 4174 22 | 220-230 V - 50 Hz / 240-260 V - 60 Hz | 1864 | 1 |
| 4174 23 | 380-400 V - 50 Hz / 440-460 V - 60 Hz | 1864 | 1 |

With 2 NO auxiliary contacts

Can not attach to MPX³ 32S

| | | | |
|---------|--|------|---|
| 4174 30 | 24 V - 50 Hz / 28 V - 60 Hz | 2486 | 1 |
| 4174 31 | 110 V - 50 Hz / 120 V - 60 Hz | 2486 | 1 |
| 4174 32 | 220-230 V - 50 Hz / 240-260 V - 60 Hz | 2486 | 1 |
| 4174 33 | 380-400 V - 50 Hz / 440-460 V - 60 Hz | 2486 | 1 |

Dial Cover

Sealable cover to protect the set value from the operation that is not intended

Without auxiliary contact

| | | | |
|---------|-----------------------------------|----|----|
| 4174 79 | For all types of MPX ³ | 88 | 50 |
|---------|-----------------------------------|----|----|

Direct adaptor and mounting unit

For mounting CTX³ contactors under MPX³ MPCBs

Direct adaptators

Used to connect MPX³ directly with the contactor

| | | | |
|---------|--|-----|---|
| 4174 40 | For MPX ³ 32S with CTX ³ mini AC | 434 | 2 |
| 4174 41 | For MPX ³ 32S with CTX ³ mini DC | 434 | 2 |
| 4174 42 | For MPX ³ 32H/32MA with CTX ³ mini AC | 434 | 2 |
| 4174 43 | For MPX ³ 32H/32MA with CTX ³ mini DC | 434 | 2 |
| 4174 48 | For MPX ³ 32S with CTX ³ 22 AC | 522 | 2 |
| 4174 49 | For MPX ³ 32S with CTX ³ 22 DC | 522 | 2 |
| 4174 50 | For MPX ³ 32H/32MA with CTX ³ 22 AC | 522 | 2 |

Direct adaptators

Used to connect MPX³ directly with the contactor

| | | | |
|---------|--|-----|---|
| 4174 51 | For MPX ³ 32H/32MA with CTX ³ 22 DC | 522 | 2 |
|---------|--|-----|---|



4174 50



4174 56



4174 61



4174 63



4174 73



4174 81

MPCBs MPX³ accessories

| Cat.Nos | Description | MRP* ₹ / Unit | Pack |
|---------|-------------|------------------|------|
|---------|-------------|------------------|------|

Used to connect MPX³ directly with the contactor

| | | | |
|---------|---|-----|---|
| 4174 52 | For MPX ³ 32S with CTX ³ 40 AC | 632 | 2 |
| 4174 53 | For MPX ³ 32S with CTX ³ 40 DC | 632 | 2 |
| 4174 54 | For MPX ³ 32H/32MA with CTX ³ 40 AC | 632 | 2 |
| 4174 55 | For MPX ³ 32H/32MA with CTX ³ 40 DC | 632 | 2 |
| 4174 56 | For MPX ³ 63H with CTX ³ 65 AC with cage type terminals | 762 | 2 |
| 4174 57 | For MPX ³ 63H with CTX ³ 65 DC with cage type terminals | 762 | 2 |
| 4174 58 | For MPX ³ 100H with CTX ³ 100 AC with cage type terminals | 762 | 1 |
| 4174 59 | For MPX ³ 100H with CTX ³ 100 DC with cage type terminals | 762 | 1 |

Mounting unit

This device is used for joining together MPX³ MPCBs and CTX³ contactors

| | | | |
|---------|--------------------------------------|------|---|
| 4174 60 | For MPX ³ 32S/32H/32MA | 588 | 2 |
| 4174 61 | For MPX ³ 63H | 1086 | 1 |
| 4174 62 | For MPX ³ 100H | 1308 | 1 |

Rotary handle

Mounting on panel's door to control the MPX³

| | | | |
|---------|---------------------------------------|------|---|
| 4174 63 | For MPX ³ 32H and 32 MA | 2178 | 1 |
| 4174 64 | For MPX ³ 63H | 2178 | 1 |
| 4174 65 | For MPX ³ 100H | 2178 | 1 |

Phase busbar

For parallel connection of MPX³

For MPX³ 32S, 32H and 32MA

Rated current 63 A

| | | | |
|---------|---------------------------------|------|---|
| 4174 71 | 2 devices | 610 | 5 |
| 4174 73 | 3 devices | 1526 | 5 |
| 4174 75 | 4 devices | 1526 | 5 |
| 4174 76 | 5 devices | 1526 | 5 |
| 4174 77 | Feeder for phase busbar 32 A | 426 | 5 |

For MPX³ 63H

Rated current 108 A

| | | | |
|---------|-----------|------|---|
| 4174 72 | 2 devices | 1086 | 5 |
| 4174 74 | 3 devices | 1634 | 5 |

Enclosures for MPX³ 32H and 32MA

IP 65 enclosure to use in dusty areas as well as in presence of corrosive gas or liquid

| | | | |
|---------|----------------------------------|------|---|
| 4174 80 | Yellow/red with rotary handle | 1256 | 1 |
| 4174 81 | With black rotary handle | 1634 | 1 |

* MRP - Maximum Retail Price Inclusive of all taxes including GST.

Bold Cat.Nos are products normally available with Legrand (India) Stockists. Cat.Nos that are not bold - delivery within 4 - 8 weeks from the date of order. Bold packing quantity is our mandatory packing. Orders to be placed by Legrand (India) Stockist in multiples of the same.

XL³

ENCLOSURE FOR SAFETY AND FLEXIBILITY

PROTECTION & DISTRIBUTION UP TO 6300 A



A complete solution for your distribution needs



INDUSTRIAL
PLANTS



COMMERCIAL
BUILDINGS



RESIDENTIAL
BUILDINGS



INFRASTRUCTURE



DATA CENTER



- Totally type-tested system as per IEC 61439-1 & 2
- Completely bolted system for ease of assembly
- Modular design for numerous configurations
- Short time current withstand capacity upto 110 kA
- Design suitable for Form 4b
- IP 55 and IP 43
- Fire resistance of 750 °C for 30 sec
- Compatible with Zucchini busbar trunking system
- Adjustable plinth height for the better spreading of cables
- Permanent earthing for internal components and external faceplates
- Perfectly house the whole range of Legrand ACBs, MCCBs, Capacitors, Contactors, MCBs, Metering devices and OMPs like VSP, MPCB etc.

Alpx³

SELF-HEALING
ENERGY EFFICIENT
CAPACITORS



KEY FEATURES

ROBUST PERFORMANCE EVEN STANDARD DUTY CAN BE USED IN 10% THDI

- Better heat dissipation
- Ease of installation
- Premium quality
- Compact design
- Low energy loss
- Built-in terminal connectors
- Self-healing technology for longer life

APPLICATION BENEFITS



REDUCE
ELECTRICITY
BILLS



INCREASE
SYSTEM
CAPACITY



IMPROVE
VOLTAGE



REDUCE
OVERALL SYSTEM
LOSSES

Alpican™ gas filled capacitors

| Cat.Nos | Description | MRP* ₹ / Unit | Pack |
|--|-------------|------------------|------|
| Heavy duty gas filled capacitor 440 V, 3 phase, 50 Hz | | | |
| 4151 24 | 5.2 kVAr | 2500 | 1 |
| 4151 25 | 7.3 kVAr | 3476 | 1 |
| 4151 26 | 8.8 kVAr | 4110 | 1 |
| 4151 27 | 10.5 kVAr | 5002 | 1 |
| 4151 28 | 12.6 kVAr | 5884 | 1 |
| 4151 29 | 16.8 kVAr | 8254 | 1 |
| 4151 30 | 21 kVAr | 9812 | 1 |
| 4151 31 | 25.2 kVAr | 11662 | 1 |



4151 29

Alpx³

Confirms to IS13340-1&2 , IEC60831-1&2
ISI Mark
Compact Design
Self healing metallized polypropylene film
Over pressure device for disconnection
Low energy losses
Resistance to high temperature
Resin filled

Can be used in system with <= 10% THDi

Standard duty can-type 440 V

| | | | |
|---------|--------------------------------|------|---|
| 5150 00 | 1 kVAr Resin std duty 440 V | 238 | 1 |
| 5150 01 | 2 kVAr Resin std duty 440 V | 478 | 1 |
| 5150 02 | 3 kVAr Resin std duty 440 V | 716 | 1 |
| 5150 03 | 4 kVAr Resin std duty 440 V | 954 | 1 |
| 5150 04 | 5 kVAr Resin std duty 440 V | 1120 | 1 |
| 5150 05 | 7.5 kVAr Resin std duty 440 V | 1678 | 1 |
| 5150 06 | 10 kVAr Resin std duty 440 V | 2238 | 1 |
| 5150 07 | 12.5 kVAr Resin std duty 440 V | 2798 | 1 |
| 5150 08 | 15 kVAr Resin std duty 440 V | 3358 | 1 |
| 5150 09 | 20 kVAr Resin std duty 440 V | 4476 | 1 |
| 5150 10 | 25 kVAr Resin std duty 440 V | 5596 | 1 |
| 5150 11 | 30 kVAr Resin std duty 440 V | 6940 | 1 |



5150 04



5150 06

Standard duty can-type 480 V

| | | | |
|---------|-----------------------|------|---|
| 5150 24 | 4.2 kVAr Resin 480 V | 2104 | 1 |
| 5150 25 | 6.9 kVAr Resin 480 V | 2902 | 1 |
| 5150 26 | 8.7 kVAr Resin 480 V | 4376 | 1 |
| 5150 27 | 10.4 kVAr Resin 480 V | 5258 | 1 |
| 5150 28 | 14 kVAr Resin 480 V | 5890 | 1 |
| 5150 29 | 17.4 kVAr Resin 480 V | 7102 | 1 |
| 5150 30 | 20.8 kVAr Resin 480 V | 9034 | 1 |

Standard duty can-type 525 V

| | | | |
|---------|-----------------------|-------|---|
| 5150 31 | 5 kVAr Resin 525 V | 2292 | 1 |
| 5150 32 | 8.3 kVAr Resin 525 V | 4682 | 1 |
| 5150 33 | 10.4 kVAr Resin 525 V | 5678 | 1 |
| 5150 34 | 12.5 kVAr Resin 525 V | 6126 | 1 |
| 5150 35 | 16.7 kVAr Resin 525 V | 7486 | 1 |
| 5150 36 | 20.8 kVAr Resin 525 V | 9576 | 1 |
| 5150 37 | 25 kVAr Resin 525 V | 11208 | 1 |

* MRP - Maximum Retail Price Inclusive of all taxes including GST.
Red Cat.Nos - new products

NEW!

Alpx³ Resin filled capacitors

| Cat.Nos | Description | MRP* ₹ / Unit | Pack |
|-------------------------------------|-----------------------------------|------------------|------|
| Standard duty box-type 440 V | | | |
| 5150 40 | 1 kVAr Std box Capacitor 440 V | 314 | 1 |
| 5150 41 | 2 kVAr Std box Capacitor 440 V | 626 | 1 |
| 5150 42 | 3 kVAr Std box Capacitor 440 V | 940 | 1 |
| 5150 43 | 4 kVAr Std box Capacitor 440 V | 1252 | 1 |
| 5150 44 | 5 kVAr Std box Capacitor 440 V | 1500 | 1 |
| 5150 45 | 7.5 kVAr Std box Capacitor 440 V | 2252 | 1 |
| 5150 46 | 8.33 kVAr Std box Capacitor 440 V | 2492 | 1 |
| 5150 47 | 10 kVAr Std box Capacitor 440 V | 3002 | 1 |
| 5150 48 | 12.5 kVAr Std box Capacitor 440 V | 3754 | 1 |
| 5150 49 | 15 kVAr Std box Capacitor 440 V | 4504 | 1 |
| 5150 50 | 20 kVAr Std box Capacitor 440 V | 6004 | 1 |
| 5150 51 | 25 kVAr Std box Capacitor 440 V | 7506 | 1 |
| 5150 52 | 50 kVAr Std box Capacitor 440 V | 17886 | 1 |



5150 47

Can be used in system with <= 15% THDi
Heavy duty can-type 440 V

| | | | |
|---------|----------------------------------|-------|---|
| 5150 12 | 1 kVAr Resin heavy duty 440 V | 442 | 1 |
| 5150 13 | 2 kVAr Resin heavy duty 440 V | 884 | 1 |
| 5150 14 | 3 kVAr Resin heavy duty 440 V | 1180 | 1 |
| 5150 15 | 4 kVAr Resin heavy duty 440 V | 1572 | 1 |
| 5150 16 | 5 kVAr Resin heavy duty 440 V | 1864 | 1 |
| 5150 17 | 7.5 kVAr Resin heavy duty 440 V | 2798 | 1 |
| 5150 18 | 10 kVAr Resin heavy duty 440 V | 3730 | 1 |
| 5150 19 | 12.5 kVAr Resin heavy duty 440 V | 4664 | 1 |
| 5150 20 | 15 kVAr Resin heavy duty 440 V | 5596 | 1 |
| 5150 21 | 20 kVAr Resin heavy duty 440 V | 7264 | 1 |
| 5150 22 | 25 kVAr Resin heavy duty 440 V | 9082 | 1 |
| 5150 23 | 30 kVAr Resin heavy duty 440 V | 11998 | 1 |
| 5150 53 | 5 kVAr HD box capacitor 440 V | 2228 | 1 |
| 5150 54 | 7.5 kVAr HD box capacitor 440 V | 3342 | 1 |
| 5150 55 | 8.33 kVAr HD box capacitor 440 V | 3700 | 1 |
| 5150 56 | 10 kVAr HD box capacitor 440 V | 4456 | 1 |
| 5150 57 | 12.5 kVAr HD box capacitor 440 V | 5570 | 1 |
| 5150 58 | 15 kVAr HD box capacitor 440 V | 6686 | 1 |
| 5150 59 | 20 kVAr HD box capacitor 440 V | 8720 | 1 |
| 5150 60 | 25 kVAr HD box capacitor 440 V | 10902 | 1 |
| 5150 61 | 50 kVAr HD box capacitor 440 V | 21802 | 1 |



5150 23

Bold Cat.Nos are products normally available with Legrand (India) Stockists.
Cat.Nos that are not bold - delivery within 4 - 8 weeks from the date of order.
Bold packing quantity is our mandatory packing. Orders to be placed by Legrand (India) Stockist in multiples of the same.

Reactors

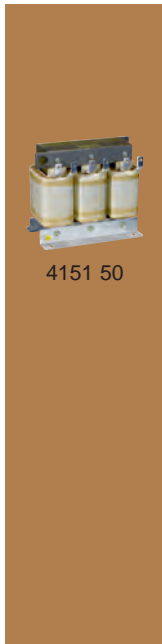

| Cat.Nos | Description | MRP* ₹ / Unit | Pack |
|------------------------------------|--------------------|---------------------|------|
| Reactors 7 % duty | | | |
| 4151 48 | Reactor 10 kVAr | 13676 | 1 |
| 4151 49 | Reactor 12.5 kVAr | 17908 | 1 |
| 4151 50 | Reactor 25 kVAr | 22802 | 1 |
| 4151 51 | Reactor 50 kVAr | 37086 | 1 |
| 4151 52 | Reactor 100 kVAr | 74282 | 1 |
| Reactors 14 % duty | | | |
| 4151 53 | Reactor 12.5 kVAr | 22640 | 1 |
| 4151 54 | Reactor 25 kVAr | 37736 | 1 |
| 4151 55 | Reactor 50 kVAr | 49890 | 1 |
| Power factor controller Eco | | | |
| 4151 95 | 4 step controller | 14690 | 1 |
| 4151 96 | 6 step controller | 13318 | 1 |
| 4151 97 | 8 step controller | 14940 | 1 |
| 4151 98 | 12 step controller | 17760 | 1 |

* MRP - Maximum Retail Price Inclusive of all taxes including GST.
Red Cat.Nos - new products

Warranty

- The Company, at its discretion, will replace products if they have any manufacturing defect within 1 years for capacitor, Reactor & APFC controller.
- The above guarantee is applicable when the products are selected taken into consideration all the technical characteristics of the product published in our catalogue.
- The guarantee is only applicable when the products are installed as per the Company's instructions and not tampered in any manner.
- The guarantee states the Company's entire liability. It does not extend to cover consequential loss or damage or installation costs arising from defective products.

Alpx3 range of capacitor - Selection Chart

DETERMINING THE CAPACITOR BANK TYPE ACCORDING TO THE LEVEL OF HARMONICS

For supplies with a high level of harmonic pollution, Legrand recommends capacitor banks with detuned reactors.

The detuned reactor performs a threefold role:



- Increasing the capacitor impedance in relation to the harmonic currents
- Shifting the parallel resonance frequency (Fr.p) of the source and capacitor to below the main

frequencies of the harmonic currents that are causing interference.

| Tuning frequency (Hz) | Blocking factor (P%) | Tuning number (n) |
|-----------------------|----------------------|-------------------|
| 189 | 7 | 3.78 |
| 135 | 14 | 2.7 |

- Helping to reduce harmonic levels in the supply.

The table opposite can be used to select the capacitor bank type according to the degree of harmonic pollution, by measuring the percentage of THDi and THDu or by estimating the percentage total power of SH/ST non-linear loads.

| Measurements | | Estimates | Type of capacitor to be used | Reactor to be used |
|--------------|--------|-----------|------------------------------|---|
| THDu % | THDi % | SH/ST % | | |
| ≤ 3 | ≤ 10 | ≤ 15 | Standard Duty | - |
| ≤ 4 | ≤ 15 | ≤ 25 | Heavy Duty | - |
| ≤ 6 | ≤ 30 | ≤ 35 | Standard Duty | 7% Reactor *14% Reactor if high level of 3rd order harmonics |
| ≤ 8 | ≤ 40 | ≤ 50 | Heavy Duty | 7% Reactor |

SH (kVA) is the weighted total power of the harmonic generators present at the transformer secondary.

ST (kVA) is the power rating of the HV/LV transformer.

THDi = Total Harmonic Distortion (THD) is the ratio of the rms value of the harmonic currents In of the order n to the rms value of the fundamental.

THDu = Voltage Distortion (THDu) is caused mainly by the high level of Current Distortion (THDi) and the level of THDu is dependent on the source impedance.

* for example if -

- Ih5 > 0.2xI45
- Ih3 : 3rd order harmonic currents
- Ih5 : 5th order harmonic currents

Note: These statements are based on our knowledge of typical application. We clearly point out that these statements cannot be regarded as binding statements about the suitability of our products for a particular customer application. It is necessary that the customer should check and decide whether the product is suitable for use in a particular application.

SURGE PROTECTIVE DEVICES

SOLUTIONS FOR ALL INSTALLATIONS AND RISK LEVELS

Clear, easily identifiable marking for easier maintenance, design in line with other Legrand modular equipment, well thought features: the new SPDs integrate perfectly in the modular rows of Legrand distribution boards and protects sensitive equipment.

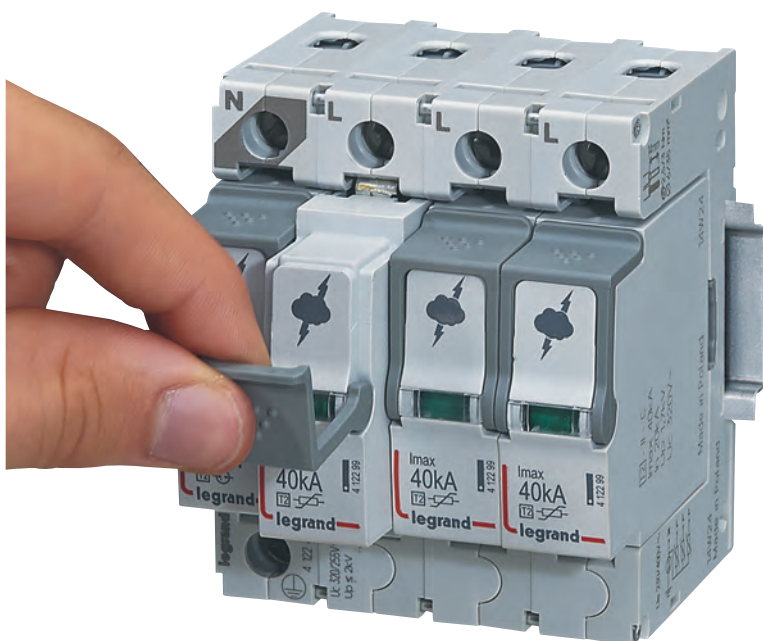

Easier to handle: the plug-in modules are easy to replace thanks to the extraction handles.

Status indicator and remote monitoring of information



- 1** Fault signal contact
- 2** Status indicator

Design and marking



- 3** Dedicated marking for easier identification and maintenance of the SPDs.

DX³

THE NEXT STEP

Presenting, DX³, an international range of protection devices. Its revolutionary design supports all kind of installations thus giving a never before experience. With 10 patents and 13 new features, it defines the next step in the protection category.



COPYTRACER

Anti-counterfeit registration number



Bottom clamp



Improved air channels



Environment friendly

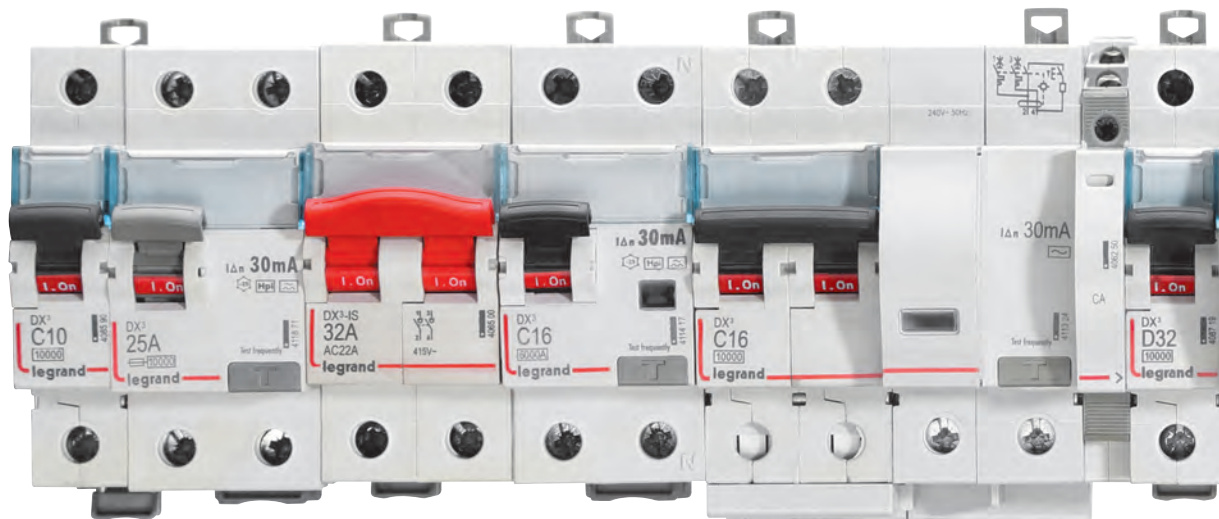

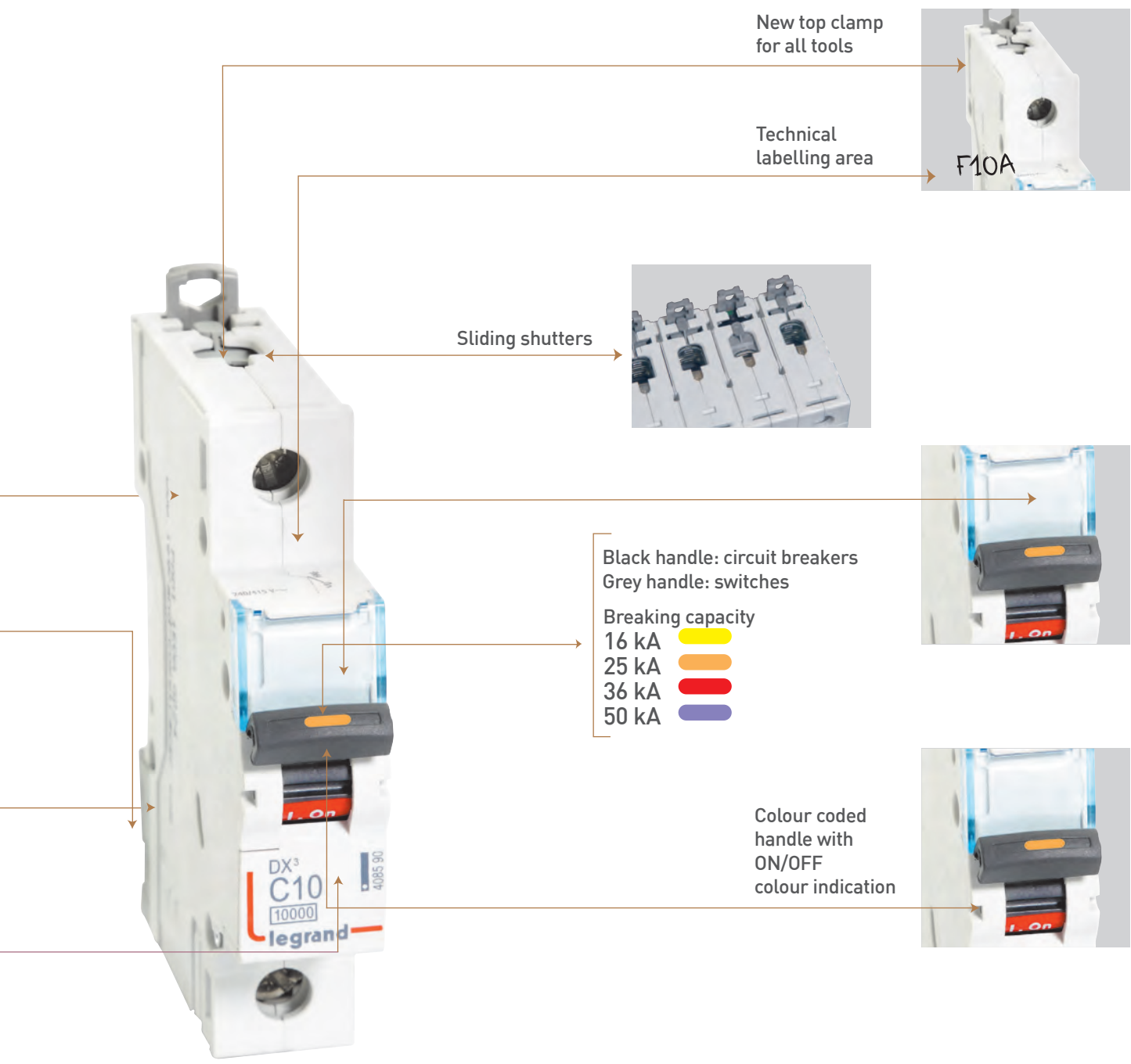

DX³ MCBs

| Cat.Nos | Nominal Rating | Number of 17.5 mm modules | MRP* ₹ / Unit | Pack |
|---------|----------------|---------------------------|---------------|------|
|---------|----------------|---------------------------|---------------|------|

MCBs for AC applications till 63 A

10 kA ISI marked as per IS/IEC 60898-1 2002
 Integrated label holder
 Sliding bottom clamp
 Efficient air channels
 Color coded On/Off indication on dolly
 Biconnect lower terminals
 IP 20 protected terminals
 Sliding shutters
 Compatible with signal and control Auxiliaries
 DC-80 V per pole - 1 kA

C Curve

Single pole 240/410 V

| | | | | |
|----------------|-----|---|-----|----------|
| 4085 80 | 0.5 | 1 | 458 | 1/10/120 |
| 4085 81 | 1 | 1 | 458 | 1/10/120 |
| 4085 83 | 2 | 1 | 458 | 1/10/120 |
| 4085 84 | 3 | 1 | 458 | 1/10/120 |
| 4085 85 | 4 | 1 | 458 | 1/10/120 |
| 4085 87 | 6 | 1 | 284 | 1/10/120 |
| 4085 90 | 10 | 1 | 284 | 1/10/120 |
| 4085 92 | 16 | 1 | 284 | 1/10/120 |
| 4085 93 | 20 | 1 | 284 | 1/10/120 |
| 4085 94 | 25 | 1 | 284 | 1/10/120 |
| 4085 95 | 32 | 1 | 284 | 1/10/120 |
| 4085 96 | 40 | 1 | 628 | 1/10/120 |
| 4085 97 | 50 | 1 | 628 | 1/10/120 |
| 4085 98 | 63 | 1 | 628 | 1/10/120 |

Single pole + Neutral 240 V

| | | | | |
|----------------|-----|---|------|--------|
| 4086 02 | 0.5 | 2 | 1228 | 1/5/60 |
| 4086 03 | 1 | 2 | 1228 | 1/5/60 |
| 4086 05 | 2 | 2 | 1228 | 1/5/60 |
| 4086 06 | 3 | 2 | 1228 | 1/5/60 |
| 4086 07 | 4 | 2 | 1228 | 1/5/60 |
| 4086 09 | 6 | 2 | 850 | 1/5/60 |
| 4086 12 | 10 | 2 | 850 | 1/5/60 |
| 4086 14 | 16 | 2 | 850 | 1/5/60 |
| 4086 15 | 20 | 2 | 850 | 1/5/60 |
| 4086 16 | 25 | 2 | 850 | 1/5/60 |
| 4086 17 | 32 | 2 | 850 | 1/5/60 |
| 4086 18 | 40 | 2 | 1384 | 1/5/60 |
| 4086 19 | 50 | 2 | 1384 | 1/5/60 |
| 4086 20 | 63 | 2 | 1384 | 1/5/60 |

Double pole 415 V

| | | | | |
|----------------|-----|---|------|------|
| 4086 21 | 0.5 | 2 | 1218 | 1/40 |
| 4086 22 | 1 | 2 | 1218 | 1/40 |
| 4086 24 | 2 | 2 | 1218 | 1/40 |
| 4086 25 | 3 | 2 | 1218 | 1/40 |
| 4086 26 | 4 | 2 | 1218 | 1/40 |
| 4086 28 | 6 | 2 | 864 | 1/40 |
| 4086 31 | 10 | 2 | 864 | 1/40 |
| 4086 33 | 16 | 2 | 864 | 1/40 |
| 4086 34 | 20 | 2 | 864 | 1/40 |
| 4086 35 | 25 | 2 | 864 | 1/40 |
| 4086 36 | 32 | 2 | 864 | 1/40 |
| 4086 37 | 40 | 2 | 1390 | 1/40 |
| 4086 38 | 50 | 2 | 1390 | 1/40 |
| 4086 39 | 63 | 2 | 1390 | 1/40 |

Triple pole 415 V

| | | | | |
|----------------|-----|---|------|------|
| 4086 43 | 0.5 | 3 | 1882 | 1/32 |
| 4086 44 | 1 | 3 | 1882 | 1/32 |
| 4086 46 | 2 | 3 | 1882 | 1/32 |
| 4086 47 | 3 | 3 | 1882 | 1/32 |
| 4086 48 | 4 | 3 | 1882 | 1/32 |
| 4086 50 | 6 | 3 | 1410 | 1/32 |
| 4086 53 | 10 | 3 | 1410 | 1/32 |
| 4086 55 | 16 | 3 | 1410 | 1/32 |
| 4086 56 | 20 | 3 | 1410 | 1/32 |
| 4086 57 | 25 | 3 | 1410 | 1/32 |
| 4086 58 | 32 | 3 | 1410 | 1/32 |
| 4086 59 | 40 | 3 | 2152 | 1/32 |
| 4086 60 | 50 | 3 | 2152 | 1/32 |
| 4086 61 | 63 | 3 | 2152 | 1/32 |

* MRP - Maximum Retail Price Inclusive of all taxes including GST.
 ♦ For further details on product contact nearest Legrand Sales Office.

DX³ MCBs

| Cat.Nos | Nominal Rating | Number of 17.5 mm modules | MRP* ₹ / Unit | Pack |
|---------|----------------|---------------------------|---------------|------|
|---------|----------------|---------------------------|---------------|------|

Triple pole + Neutral 415 V

| | | | | |
|----------------|-----|---|------|------|
| 4086 65 | 0.5 | 4 | 2358 | 1/32 |
| 4086 66 | 1 | 4 | 2358 | 1/32 |
| 4086 68 | 2 | 4 | 2358 | 1/32 |
| 4086 69 | 3 | 4 | 2358 | 1/32 |
| 4086 70 | 4 | 4 | 2358 | 1/32 |
| 4086 72 | 6 | 4 | 1904 | 1/32 |
| 4086 75 | 10 | 4 | 1904 | 1/32 |
| 4086 77 | 16 | 4 | 1904 | 1/32 |
| 4086 78 | 20 | 4 | 1904 | 1/32 |
| 4086 79 | 25 | 4 | 1904 | 1/32 |
| 4086 80 | 32 | 4 | 1904 | 1/32 |
| 4086 81 | 40 | 4 | 2746 | 1/32 |
| 4086 82 | 50 | 4 | 2746 | 1/32 |
| 4086 83 | 63 | 4 | 2746 | 1/32 |

Four pole 415 V

| | | | | |
|----------------|-----|---|------|------|
| 4086 84 | 0.5 | 4 | 2358 | 1/32 |
| 4086 85 | 1 | 4 | 2358 | 1/32 |
| 4086 87 | 2 | 4 | 2358 | 1/32 |
| 4086 88 | 3 | 4 | 2358 | 1/32 |
| 4086 89 | 4 | 4 | 2358 | 1/32 |
| 4086 91 | 6 | 4 | 1904 | 1/32 |
| 4086 94 | 10 | 4 | 1904 | 1/32 |
| 4086 96 | 16 | 4 | 1904 | 1/32 |
| 4086 97 | 20 | 4 | 1904 | 1/32 |
| 4086 98 | 25 | 4 | 1904 | 1/32 |
| 4086 99 | 32 | 4 | 1904 | 1/32 |
| 4087 00 | 40 | 4 | 2746 | 1/32 |
| 4087 01 | 50 | 4 | 2746 | 1/32 |
| 4087 02 | 63 | 4 | 2746 | 1/32 |

D Curve

Single pole 240/415 V

| | | | | |
|----------|-----|---|-----|----------|
| 4087 06 | 0.5 | 1 | 454 | 1/10/120 |
| 4087 07 | 1 | 1 | 454 | 1/10/120 |
| 4087 09 | 2 | 1 | 454 | 1/10/120 |
| 4087 10 | 3 | 1 | 454 | 1/10/120 |
| 4087 11 | 4 | 1 | 454 | 1/10/120 |
| 4087 12 | 6 | 1 | 374 | 1/10/120 |
| 4087 14 | 10 | 1 | 374 | 1/10/120 |
| 4087 16 | 16 | 1 | 374 | 1/10/120 |
| 4087 17 | 20 | 1 | 374 | 1/10/120 |
| 4087 18 | 25 | 1 | 374 | 1/10/120 |
| 4087 19 | 32 | 1 | 374 | 1/10/120 |
| 4087 20* | 40 | 1 | 672 | 1/10/120 |
| 4087 21* | 50 | 1 | 672 | 1/10/120 |
| 4087 22* | 63 | 1 | 672 | 1/10/120 |

Single pole + Neutral 240 V

| | | | | |
|---------|-----|---|------|--------|
| 4087 26 | 0.5 | 2 | 1216 | 1/5/60 |
| 4087 27 | 1 | 2 | 1216 | 1/5/60 |
| 4087 29 | 2 | 2 | 1216 | 1/5/60 |
| 4087 30 | 3 | 2 | 1216 | 1/5/60 |
| 4087 31 | 4 | 2 | 1216 | 1/5/60 |

Double pole 415 V

| | | | | |
|----------|-----|---|------|------|
| 4087 32 | 0.5 | 2 | 1216 | 1/40 |
| 4087 33 | 1 | 2 | 1216 | 1/40 |
| 4087 35 | 2 | 2 | 1216 | 1/40 |
| 4087 36 | 3 | 2 | 1216 | 1/40 |
| 4087 37 | 4 | 2 | 1216 | 1/40 |
| 4087 38 | 6 | 2 | 900 | 1/40 |
| 4087 40 | 10 | 2 | 900 | 1/40 |
| 4087 42 | 16 | 2 | 900 | 1/40 |
| 4087 43 | 20 | 2 | 900 | 1/40 |
| 4087 44 | 25 | 2 | 900 | 1/40 |
| 4087 45 | 32 | 2 | 900 | 1/40 |
| 4087 46* | 40 | 2 | 1456 | 1/40 |
| 4087 47* | 50 | 2 | 1456 | 1/40 |
| 4087 48* | 63 | 2 | 1456 | 1/40 |

Bold Cat.Nos are products normally available with Legrand (India) Stockists.
 Cat.Nos that are not bold - delivery within 4 - 8 weeks from the date of order.
 Bold packing quantity is our mandatory packing. Orders to be placed by Legrand (India) Stockist in multiples of the same.

DX³ MCBs

| Cat.Nos | Nominal Rating | Number of 17.5 mm modules | MRP* ₹ / Unit | Pack |
|---------|----------------|---------------------------|------------------|------|
|---------|----------------|---------------------------|------------------|------|

Triple pole 415 V

| | | | | |
|----------|-----|---|------|------|
| 4087 52 | 0.5 | 3 | 1882 | 1/32 |
| 4087 53 | 1 | 3 | 1882 | 1/32 |
| 4087 55 | 2 | 3 | 1882 | 1/32 |
| 4087 56 | 3 | 3 | 1882 | 1/32 |
| 4087 57 | 4 | 3 | 1882 | 1/32 |
| 4087 58 | 6 | 3 | 1484 | 1/32 |
| 4087 60 | 10 | 3 | 1484 | 1/32 |
| 4087 62 | 16 | 3 | 1484 | 1/32 |
| 4087 63 | 20 | 3 | 1484 | 1/32 |
| 4087 64 | 25 | 3 | 1484 | 1/32 |
| 4087 65 | 32 | 3 | 1484 | 1/32 |
| 4087 66* | 40 | 3 | 2290 | 1/32 |
| 4087 67* | 50 | 3 | 2290 | 1/32 |
| 4087 68* | 63 | 3 | 2290 | 1/32 |



4087 52

Triple pole + Neutral 415 V

| | | | | |
|---------|-----|---|------|------|
| 4087 72 | 0.5 | 4 | 2358 | 1/32 |
| 4087 73 | 1 | 4 | 2358 | 1/32 |
| 4087 75 | 2 | 4 | 2358 | 1/32 |
| 4087 76 | 3 | 4 | 2358 | 1/32 |
| 4087 77 | 4 | 4 | 2358 | 1/32 |

Four pole 415 V

| | | | | |
|----------|-----|---|------|------|
| 4087 78 | 0.5 | 4 | 2358 | 1/32 |
| 4087 79 | 1 | 4 | 2358 | 1/32 |
| 4087 81 | 2 | 4 | 2358 | 1/32 |
| 4087 82 | 3 | 4 | 2358 | 1/32 |
| 4087 83 | 4 | 4 | 2358 | 1/32 |
| 4087 84 | 6 | 4 | 1976 | 1/32 |
| 4087 86 | 10 | 4 | 1976 | 1/32 |
| 4087 88 | 16 | 4 | 1976 | 1/32 |
| 4087 89 | 20 | 4 | 1976 | 1/32 |
| 4087 90 | 25 | 4 | 1976 | 1/32 |
| 4087 91 | 32 | 4 | 1976 | 1/32 |
| 4087 92* | 40 | 4 | 2852 | 1/32 |
| 4087 93* | 50 | 4 | 2852 | 1/32 |
| 4087 94* | 63 | 4 | 2852 | 1/32 |



4087 90

Circuit breakers AC applications 80 - 125 A

10 kA as per IEC 60947-2
Integrated label holder
Sliding insulating shield
Color coded contact indication window
IP 20 protected terminals
50 sq mm terminals



4086 00

Single pole 230 V / 400 V

| | | | | |
|---------|-----|-----|------|---------|
| 4085 99 | 80 | 1.5 | 2322 | 1/5/160 |
| 4086 00 | 100 | 1.5 | 2576 | 1/5/161 |
| 4086 01 | 125 | 1.5 | 2754 | 1/5/162 |



4086 40

Double pole 230 V / 400 V

| | | | | |
|---------|-----|---|------|--------|
| 4086 40 | 80 | 3 | 5124 | 1/5/60 |
| 4086 41 | 100 | 3 | 5412 | 1/5/60 |
| 4086 42 | 125 | 3 | 5892 | 1/5/60 |



4086 63

Triple pole 400 V

| | | | | |
|---------|-----|-----|------|-----|
| 4086 62 | 80 | 4.5 | 8074 | 1/9 |
| 4086 63 | 100 | 4.5 | 8522 | 1/9 |
| 4086 64 | 125 | 4.5 | 9364 | 1/9 |



4087 05

Four pole 400 V

| | | | | |
|---------|-----|---|-------|-----|
| 4087 03 | 80 | 6 | 10524 | 1/9 |
| 4087 04 | 100 | 6 | 10862 | 1/9 |
| 4087 05 | 125 | 6 | 12168 | 1/9 |

* MRP - Maximum Retail Price Inclusive of all taxes including GST.
♦ For further details on product contact nearest Legrand Sales Office.

DX³ MCBs

| Cat.Nos | Nominal Rating | Number of 17.5 mm modules | MRP* ₹ / Unit | Pack |
|---------|----------------|---------------------------|------------------|------|
|---------|----------------|---------------------------|------------------|------|

Circuit breakers DC applications upto 63 A

6 kA as per IEC 60947-2
Integrated label holder
Sliding bottom clamp
Improved air channels
Color coded On/Off indication on dolly
Biconnect lower terminals
IP 20 protected terminals
Sliding shutters

Single pole 250 V

| | | | | |
|----------|-----|---|-----|----------|
| 4087 98* | 0.5 | 1 | 716 | 1/10/120 |
| 4087 99* | 1 | 1 | 716 | 1/10/120 |
| 4088 01* | 2 | 1 | 716 | 1/10/120 |
| 4088 02* | 3 | 1 | 716 | 1/10/120 |
| 4088 03* | 4 | 1 | 716 | 1/10/120 |
| 4088 04* | 6 | 1 | 594 | 1/10/120 |
| 4088 06* | 10 | 1 | 594 | 1/10/120 |
| 4088 08* | 16 | 1 | 594 | 1/10/120 |
| 4088 09* | 20 | 1 | 594 | 1/10/120 |
| 4088 10* | 25 | 1 | 594 | 1/10/120 |
| 4088 11* | 32 | 1 | 594 | 1/10/120 |
| 4088 12* | 40 | 1 | 784 | 1/10/120 |
| 4088 13* | 50 | 1 | 784 | 1/10/120 |
| 4088 14* | 63 | 1 | 784 | 1/10/120 |



4088 12

Double pole 250 V

| | | | | |
|----------|-----|---|------|--------|
| 4088 15* | 0.5 | 1 | 1444 | 1/5/60 |
| 4088 16* | 1 | 1 | 1444 | 1/5/60 |
| 4088 18* | 2 | 1 | 1444 | 1/5/60 |
| 4088 19* | 3 | 1 | 1444 | 1/5/60 |
| 4088 20* | 4 | 1 | 1444 | 1/5/60 |
| 4088 21* | 6 | 1 | 1264 | 1/5/60 |
| 4088 23* | 10 | 1 | 1264 | 1/5/60 |
| 4088 25* | 16 | 1 | 1264 | 1/5/60 |
| 4088 26* | 20 | 1 | 1264 | 1/5/60 |
| 4088 27* | 25 | 1 | 1264 | 1/5/60 |
| 4088 28* | 32 | 1 | 1264 | 1/5/60 |
| 4088 29* | 40 | 1 | 1594 | 1/5/60 |
| 4088 30* | 50 | 1 | 1594 | 1/5/60 |
| 4088 31* | 63 | 1 | 1594 | 1/5/60 |

RDSO DC MCB

Single pole

| | | | | |
|---------|-----|---|-----|----------|
| 4088 32 | 0.5 | 1 | 698 | 1/10/120 |
| 4088 33 | 1 | 1 | 698 | 1/10/120 |
| 4088 34 | 1.5 | 1 | 698 | 1/10/120 |
| 4088 35 | 1.6 | 1 | 698 | 1/10/120 |
| 4088 36 | 2.5 | 1 | 698 | 1/10/120 |
| 4088 37 | 3 | 1 | 522 | 1/10/120 |
| 4088 38 | 4 | 1 | 522 | 1/10/120 |
| 4088 39 | 5 | 1 | 632 | 1/10/120 |
| 4088 40 | 10 | 1 | 632 | 1/10/120 |
| 4088 41 | 15 | 1 | 632 | 1/10/120 |
| 4088 42 | 20 | 1 | 632 | 1/10/120 |
| 4088 43 | 25 | 1 | 632 | 1/10/120 |
| 4088 44 | 30 | 1 | 750 | 1/10/120 |
| 4088 45 | 35 | 1 | 750 | 1/10/120 |
| 4088 46 | 40 | 1 | 824 | 1/10/120 |
| 4088 47 | 50 | 1 | 824 | 1/10/120 |
| 4088 48 | 60 | 1 | 824 | 1/10/120 |

Bold Cat.Nos are products normally available with Legrand (India) Stockists.
Cat.Nos that are not bold - delivery within 4 - 8 weeks from the date of order.
Bold packing quantity is our mandatory packing. Orders to be placed by Legrand (India) Stockist in multiples of the same.

DX³ isolators

| Cat.Nos | Nominal Rating | Number of 17.5 mm modules | MRP* ₹ / Unit | Pack |
|---------|----------------|---------------------------|------------------|------|
|---------|----------------|---------------------------|------------------|------|

Isolators for AC applications upto 125 A

ISI marked as per IEC 60947-3
Integrated label holder
Ergonomic red color dolly
Sliding bottom clamp
Double break mechanism
Improved air channels
Color coded On/Off indication on dolly
Biconnect lower terminals
IP 20 protected terminals
Compatible with signal and control Auxiliaries
Sliding shutters

Double pole 240 V

| | | | | |
|----------------|-----|---|------|--------|
| 4065 00 | 32 | 2 | 476 | 1/5/60 |
| 4065 01 | 40 | 2 | 524 | 1/5/60 |
| 4065 02 | 63 | 2 | 692 | 1/5/60 |
| 4065 04 | 100 | 2 | 952 | 1/5/60 |
| 4065 05 | 125 | 2 | 1082 | 1/5/60 |



4065 00

Triple pole 415 V

| | | | | |
|----------------|-----|---|------|------|
| 4065 09 | 32 | 3 | 852 | 1/40 |
| 4065 10 | 40 | 3 | 912 | 1/40 |
| 4065 11 | 63 | 3 | 1080 | 1/40 |
| 4065 13 | 100 | 3 | 1216 | 1/40 |
| 4065 14 | 125 | 3 | 1404 | 1/40 |



4065 10

Four pole 415 V

| | | | | |
|----------------|-----|---|------|------|
| 4065 18 | 32 | 4 | 936 | 1/32 |
| 4065 19 | 40 | 4 | 1162 | 1/32 |
| 4065 20 | 63 | 4 | 1272 | 1/32 |
| 4065 22 | 100 | 4 | 1582 | 1/32 |
| 4065 23 | 125 | 4 | 1744 | 1/32 |



4065 20

DX³ RCCBs

RCCBs for AC applications upto 63 A

ISI marked as per IS 12640-1
Integrated label holder
Ergonomic Grey color dolly
Sliding bottom clamp
Compatible with signal and control Auxiliaries
Color coded On/Off indication on dolly
Biconnect lower terminals
IP 20 protected terminals
35 sq mm terminals
Sliding shutters

Double pole 240 V

30 mA

| | | | | |
|----------------|----|---|------|--------|
| 4118 51 | 25 | 2 | 3092 | 1/5/60 |
| 4118 52 | 40 | 2 | 3620 | 1/5/60 |
| 4118 53 | 63 | 2 | 4328 | 1/5/60 |



4118 51

100 mA

| | | | | |
|----------------|----|---|------|--------|
| 4118 56 | 25 | 2 | 3334 | 1/5/60 |
| 4118 57 | 40 | 2 | 3868 | 1/5/60 |
| 4118 58 | 63 | 2 | 4594 | 1/5/60 |



4118 57

300 mA

| | | | | |
|---------|----|---|------|--------|
| 4118 61 | 25 | 2 | 3394 | 1/5/60 |
| 4118 62 | 40 | 2 | 3952 | 1/5/60 |
| 4118 63 | 63 | 2 | 4624 | 1/5/60 |

Four pole 415 V

30 mA

| | | | | |
|----------------|----|---|------|------|
| 4118 76 | 25 | 4 | 4260 | 1/32 |
| 4118 77 | 40 | 4 | 4208 | 1/32 |
| 4118 78 | 63 | 4 | 4882 | 1/32 |



4118 77

DX³ RCCBs

| Cat.Nos | Nominal Rating | Number of 17.5 mm modules | MRP* ₹ / Unit | Pack |
|---------|----------------|---------------------------|------------------|------|
|---------|----------------|---------------------------|------------------|------|

100 mA

| | | | | |
|----------------|----|---|------|------|
| 4118 81 | 25 | 4 | 4420 | 1/32 |
| 4118 82 | 40 | 4 | 4448 | 1/32 |
| 4118 83 | 63 | 4 | 5248 | 1/32 |



4118 83

300 mA

| | | | | |
|----------------|----|---|------|------|
| 4118 86 | 25 | 4 | 4526 | 1/32 |
| 4118 87 | 40 | 4 | 4594 | 1/32 |
| 4118 88 | 63 | 4 | 5248 | 1/32 |



4118 93

Four pole 415 V, A-S

300 mA

| | | | | |
|---------|----|---|------|--------|
| 4118 91 | 25 | 2 | 6560 | 1/5/60 |
| 4118 92 | 40 | 2 | 6644 | 1/5/60 |
| 4118 93 | 63 | 2 | 6940 | 1/5/60 |
| 4118 94 | 80 | 2 | 8118 | 1/5/60 |

Double pole 240 V, HPI

30 mA

| | | | | |
|---------|----|---|------|--------|
| 4118 71 | 25 | 2 | 6470 | 1/5/60 |
| 4118 72 | 40 | 2 | 6794 | 1/5/60 |
| 4118 73 | 63 | 2 | 6990 | 1/5/60 |
| 4118 74 | 80 | 2 | 8388 | 1/5/60 |

Four pole 415 V, HPI

30 mA

| | | | | |
|---------|----|---|------|------|
| 4118 96 | 25 | 4 | 7288 | 1/32 |
| 4118 97 | 40 | 4 | 7518 | 1/32 |
| 4118 98 | 63 | 4 | 7714 | 1/32 |
| 4118 99 | 80 | 4 | 8712 | 1/32 |

DX³ circuit breakers

AC applications upto 100 A

Integrated label holder
Ergonomic Grey color dolly
Color coded On/Off indication on dolly
Biconnect lower terminals
IP 20 protected terminals
35 sq mm terminals
Sliding shutters

Double pole 240 V

30 mA

| | | | | |
|---------|-----|---|------|--------|
| 4115 07 | 80 | 2 | 7230 | 1/5/60 |
| 4115 08 | 100 | 2 | 7860 | 1/5/60 |



4115 08



4115 07

100 mA

| | | | | |
|---------|-----|---|------|--------|
| 4115 17 | 80 | 2 | 7230 | 1/5/60 |
| 4115 18 | 100 | 2 | 7486 | 1/5/60 |



4117 05

300 mA

| | | | | |
|---------|-----|---|------|--------|
| 4115 27 | 80 | 2 | 7230 | 1/5/60 |
| 4115 28 | 100 | 2 | 7860 | 1/5/60 |

Four pole 415 V

30 mA

| | | | | |
|---------|-----|---|------|------|
| 4117 05 | 80 | 4 | 8490 | 1/32 |
| 4117 63 | 100 | 4 | 7758 | 1/32 |



4117 15

100 mA

| | | | | |
|---------|-----|---|------|------|
| 4117 15 | 80 | 4 | 8490 | 1/32 |
| 4117 73 | 100 | 4 | 7758 | 1/32 |

300 mA

| | | | | |
|---------|-----|---|------|------|
| 4117 25 | 80 | 4 | 8490 | 1/32 |
| 4117 83 | 100 | 4 | 7928 | 1/32 |



4117 25

* MRP - Maximum Retail Price Inclusive of all taxes including GST.

Bold Cat.Nos are products normally available with Legrand (India) Stockists. Cat.Nos that are not bold - delivery within 4 - 8 weeks from the date of order. Bold packing quantity is our mandatory packing. Orders to be placed by Legrand (India) Stockist in multiples of the same.

DX³ RCBOs

| Cat.Nos | Nominal Rating | Number of 17.5 mm modules | MRP* ₹ / Unit | Pack |
|---------|----------------|---------------------------|------------------|------|
|---------|----------------|---------------------------|------------------|------|

RCBOs assembled for AC applications upto 63 A

ISI marked as per IS 12640-2
Integrated label holder
Ergonomic design
Color coded On/Off indication on dolly
Compatible with signal and control Auxiliaries
Front face indication for earth leakage fault
IP 20 protected terminals
35 sq mm terminals
Sliding shutters

Double pole 240 V, AC Type

30 mA

| | | | | |
|----------------|----|---|------|------|
| 4113 22 | 6 | 4 | 3788 | 1/32 |
| 4113 23 | 10 | 4 | 3752 | 1/32 |
| 4113 24 | 16 | 4 | 3630 | 1/32 |
| 4113 25 | 25 | 4 | 3630 | 1/32 |
| 4113 26 | 32 | 4 | 3974 | 1/32 |
| 4113 27 | 40 | 4 | 4726 | 1/32 |
| 4113 28 | 63 | 4 | 5654 | 1/32 |

100 mA

| | | | | |
|----------------|----|---|------|------|
| 4113 29 | 6 | 4 | 4718 | 1/32 |
| 4113 30 | 10 | 4 | 4718 | 1/32 |
| 4113 31 | 16 | 4 | 4540 | 1/32 |
| 4113 32 | 25 | 4 | 4458 | 1/32 |
| 4113 33 | 32 | 4 | 4540 | 1/32 |
| 4113 34 | 40 | 4 | 5222 | 1/32 |
| 4113 35 | 63 | 4 | 6046 | 1/32 |

300 mA

| | | | | |
|----------------|----|---|------|------|
| 4113 36 | 16 | 4 | 4692 | 1/32 |
| 4113 37 | 25 | 4 | 4692 | 1/32 |
| 4113 38 | 32 | 4 | 4692 | 1/32 |
| 4113 39 | 40 | 4 | 5376 | 1/32 |
| 4113 40 | 63 | 4 | 6158 | 1/32 |

Four pole 415 V, AC Type

30 mA

| | | | | |
|----------------|----|---|------|------|
| 4113 88 | 6 | 7 | 5192 | 1/16 |
| 4113 89 | 10 | 7 | 5192 | 1/16 |
| 4113 65 | 16 | 7 | 5116 | 1/16 |
| 4113 66 | 25 | 7 | 5116 | 1/16 |
| 4113 67 | 32 | 7 | 5278 | 1/16 |
| 4113 68 | 40 | 7 | 5358 | 1/16 |
| 4113 69 | 63 | 7 | 6344 | 1/16 |

Four pole 415 V, AC Type

100 mA

| | | | | |
|----------------|----|---|------|------|
| 4113 70 | 16 | 7 | 5770 | 1/16 |
| 4113 71 | 25 | 7 | 5522 | 1/16 |
| 4113 72 | 32 | 7 | 5582 | 1/16 |
| 4113 73 | 40 | 7 | 5746 | 1/16 |
| 4113 74 | 63 | 7 | 6528 | 1/16 |

Four pole 415 V, AC Type

300 mA

| | | | | |
|----------------|----|---|------|------|
| 4113 75 | 16 | 7 | 5946 | 1/16 |
| 4113 76 | 25 | 7 | 5740 | 1/16 |
| 4113 77 | 32 | 7 | 5740 | 1/16 |
| 4113 78 | 40 | 7 | 5856 | 1/16 |
| 4113 79 | 63 | 7 | 6640 | 1/16 |

RCBOs compact for AC applications upto 32 A, 6 kA

Conforms to IEC 60947
Integrated label holder
Ergonomic design
Color coded On/Off indication on dolly
Front face indication for earth leakage fault
IP 20 protected terminals
35 sq mm terminals
Sliding shutters

Double pole 240 V, AC Type

30 mA

| | | | | |
|----------------|---|---|------|------|
| 4113 90 | 6 | 2 | 4408 | 1/32 |
|----------------|---|---|------|------|

* MRP - Maximum Retail Price Inclusive of all taxes including GST.

DX³ RCBOs

| Cat.Nos | Nominal Rating | Number of 17.5 mm modules | MRP* ₹ / Unit | Pack |
|---------|----------------|---------------------------|------------------|------|
|---------|----------------|---------------------------|------------------|------|

Double pole 240 V, AC Type

30 mA

| | | | | |
|----------------|----|---|------|------|
| 4113 91 | 10 | 2 | 4408 | 1/32 |
| 4113 92 | 16 | 2 | 4408 | 1/32 |
| 4113 93 | 20 | 2 | 4408 | 1/32 |
| 4113 94 | 25 | 2 | 4408 | 1/32 |
| 4113 95 | 32 | 2 | 4628 | 1/32 |

300 mA

| | | | | |
|---------|----|---|------|------|
| 4113 97 | 6 | 2 | 4540 | 1/32 |
| 4113 98 | 10 | 2 | 4620 | 1/32 |
| 4113 99 | 16 | 2 | 4620 | 1/32 |
| 4114 00 | 20 | 2 | 4620 | 1/32 |
| 4114 01 | 25 | 2 | 4620 | 1/32 |
| 4114 02 | 32 | 2 | 4852 | 1/32 |

Double pole 240 V, HPI Type

30 mA

| | | | | |
|---------|----|---|------|------|
| 4114 15 | 25 | 2 | 8454 | 1/32 |
| 4114 16 | 32 | 2 | 8934 | 1/32 |

Four pole 415 V, AC Type

30 mA

| | | | | |
|---------|----|---|------|------|
| 4114 18 | 10 | 4 | 5994 | 1/16 |
| 4114 19 | 16 | 4 | 5994 | 1/16 |
| 4114 20 | 20 | 4 | 5994 | 1/16 |
| 4114 21 | 25 | 4 | 5994 | 1/16 |
| 4111 89 | 32 | 4 | 5994 | 1/16 |

Four pole 415 V, AC Type

300 mA

| | | | | |
|---------|----|---|------|------|
| 4114 23 | 10 | 4 | 6744 | 1/16 |
| 4114 24 | 16 | 4 | 6744 | 1/16 |
| 4114 25 | 20 | 4 | 6744 | 1/16 |
| 4114 26 | 25 | 4 | 6744 | 1/16 |
| 4112 08 | 32 | 4 | 6744 | 1/16 |

Four pole 415 V, A Type

30 mA

| | | | | |
|---------|----|---|------|------|
| 4114 28 | 10 | 4 | 6762 | 1/16 |
| 4114 29 | 16 | 4 | 6762 | 1/16 |
| 4114 30 | 20 | 4 | 6762 | 1/16 |
| 4114 31 | 25 | 4 | 6762 | 1/16 |
| 4112 37 | 32 | 4 | 6762 | 1/16 |

Four pole 415 V, A Type

300 mA

| | | | | |
|---------|----|---|------|------|
| 4114 33 | 10 | 4 | 7388 | 1/16 |
| 4114 34 | 16 | 4 | 7388 | 1/16 |
| 4114 35 | 20 | 4 | 7388 | 1/16 |
| 4114 36 | 25 | 4 | 7388 | 1/16 |
| 4112 42 | 32 | 4 | 7388 | 1/16 |

DX³ RCD add on module

For 125 A

Conform to IEC 61009-1
AC type : detect AC components faults
Hpi type : detect faults with AC and DC components, increased
Immunity to false tripping
For mounting on the right-hand side of 1.5 module per pole DX³ MCBs
Easy & fast association mechanism
Terminal cover for locking
70 sq mm terminals

Double pole 240 V, AC Type

30 mA

| | | | | |
|---------|-------|---|-------|---|
| 4105 68 | 125 A | 4 | 13606 | 1 |
|---------|-------|---|-------|---|

100 mA

| | | | | |
|---------|-------|---|-------|---|
| 4105 69 | 125 A | 4 | 15338 | 1 |
|---------|-------|---|-------|---|

300 mA

| | | | | |
|---------|-------|---|-------|---|
| 4105 71 | 125 A | 4 | 15338 | 1 |
|---------|-------|---|-------|---|

Bold Cat.Nos are products normally available with Legrand (India) Stockists. Cat.Nos that are not bold - delivery within 4 - 8 weeks from the date of order. Bold packing quantity is our mandatory packing. Orders to be placed by Legrand (India) Stockist in multiples of the same.



4113 24



4113 94



4111 89



4112 08



4112 42



4113 79



4105 68

DX³ RCD add on module

| Cat.Nos | Nominal Rating | Number of 17.5 mm modules | MRP* ₹ / Unit | Pack |
|---------|----------------|---------------------------|---------------|------|
|---------|----------------|---------------------------|---------------|------|

Four pole 415 V, AC Type

30 mA

| | | | | |
|---------|-------|---|-------|---|
| 4106 25 | 125 A | 4 | 21474 | 1 |
|---------|-------|---|-------|---|

100 mA

| | | | | |
|---------|-------|---|-------|---|
| 4106 26 | 125 A | 4 | 23996 | 1 |
|---------|-------|---|-------|---|

300 mA

| | | | | |
|---------|-------|---|-------|---|
| 4106 29 | 125 A | 4 | 23996 | 1 |
|---------|-------|---|-------|---|

Double pole 240 V, HPI type

30 mA

| | | | | |
|---------|-------|---|-------|---|
| 4105 78 | 125 A | 6 | 17316 | 1 |
|---------|-------|---|-------|---|

100 mA

| | | | | |
|---------|-------|---|-------|---|
| 4105 79 | 125 A | 6 | 19356 | 1 |
|---------|-------|---|-------|---|

300 mA

| | | | | |
|---------|-------|---|-------|---|
| 4105 82 | 125 A | 6 | 19356 | 1 |
|---------|-------|---|-------|---|

Four pole 415 V, HPI type

30 mA

| | | | | |
|---------|-------|---|-------|---|
| 4106 38 | 125 A | 6 | 29686 | 1 |
|---------|-------|---|-------|---|

100 mA

| | | | | |
|---------|-------|---|-------|---|
| 4106 39 | 125 A | 6 | 31418 | 1 |
|---------|-------|---|-------|---|

300 mA

| | | | | |
|---------|-------|---|-------|---|
| 4106 42 | 125 A | 6 | 31418 | 1 |
|---------|-------|---|-------|---|

DX³ auxiliaries

Auxiliaries common for MCBs, Isolators, RCCBs & RCBOs

Easy & fast fixation on site
On site clip on mounting
Clip on fitting on left side

| Cat.Nos | Description | Number of 17.5 mm modules | MRP* ₹ / Unit | Pack |
|---------|-------------|---------------------------|---------------|------|
|---------|-------------|---------------------------|---------------|------|

Signalling auxiliaries

| | | | | |
|---------|--|-----|------|---|
| 4062 50 | Auxiliary changeover switch 6 A | 0.5 | 854 | 1 |
| 4062 52 | Fault signalling changeover switch 6 A | 0.5 | 1002 | 1 |
| 4062 64 | Changeover + fault signalling switch | 1 | 1610 | 1 |

Control auxiliaries

| | | | | |
|---------|------------------------------------|---|------|---|
| 4062 76 | Shunt release 12 /48 V AC/DC | 1 | 2334 | 1 |
| 4062 78 | Shunt release 110/415 V V AC | 1 | 2334 | 1 |
| 4062 80 | Undervoltage release 24/48 V AC/DC | 1 | 2040 | 1 |
| 4062 82 | Undervoltage release 230 V AC | 1 | 2004 | 1 |



4105 78



4062 50



4062 52



4062 78



4062 82

DX³ auxiliaries

| Cat.Nos | Description | Number of 17.5 mm modules | MRP* ₹ / Unit | Pack |
|---------|-------------|---------------------------|---------------|------|
|---------|-------------|---------------------------|---------------|------|

Control auxiliaries

| | | | | |
|---------|----------------------------------|---|-------|---|
| 4062 86 | Pop over voltage release | 1 | 2534 | 1 |
| 4062 90 | Motor control 24/48 V AC/DC | 1 | 12587 | 1 |
| 4062 91 | Motor control 110/415 V AC | 1 | 9682 | 1 |
| 4062 93 | Motor control 24/48 V AC/DC | 2 | 21782 | 1 |
| 4062 95 | Motor control 110/415 V AC | 2 | 21782 | 1 |
| 4062 88 | Automatic resetter | 2 | 9682 | 1 |
| 4062 89 | Automatic resetter with autotest | 2 | 14522 | 1 |

Rotary handle

| | | | | |
|---------|--------------------------|---|------|----|
| 4063 19 | Black rotary handle | - | 1936 | 10 |
| 4063 20 | Yellow/red rotary handle | - | 2178 | 10 |

Support for padlock

| | | | | |
|---------|-------------------------------|---|-----|----|
| 4063 03 | Support for padlock till 63 A | - | 452 | 10 |
|---------|-------------------------------|---|-----|----|

Sealable screw cover

| | | | | |
|---------|----------------------|---|------|----|
| 4063 04 | Devices upto 63 A | - | 460 | 10 |
| 4063 06 | For 80-125 A devices | - | 5034 | 10 |

1/2 module spacing unit

| | | | | |
|---------|-------------------------|-----|-----|----|
| 4063 07 | 1/2 module spacing unit | 0.5 | 170 | 10 |
|---------|-------------------------|-----|-----|----|

5 mm padlock

| | | | | |
|---------|--------------|---|-----|----|
| 4063 13 | 5 mm Padlock | - | 362 | 10 |
|---------|--------------|---|-----|----|

Manual changover switch

Compact design
Manual switching operation
Easy to assemble
Ergonomic design

For 1 mod/pole devices

| | | | | |
|---------|----------------------------------|---|------|---|
| 4063 14 | Manual change-over switch for DP | 1 | 2178 | 5 |
| 4063 15 | Manual change-over switch for TP | 1 | 2664 | 5 |
| 4063 16 | Manual change-over switch for FP | 1 | 2904 | 5 |

* MRP - Maximum Retail Price Inclusive of all taxes including GST.

Bold Cat.Nos are products normally available with Legrand (India) Stockists. Cat.Nos that are not bold - delivery within 4 - 8 weeks from the date of order. Bold packing quantity is our mandatory packing. Orders to be placed by Legrand (India) Stockist in multiples of the same.

DX³ RCD add on module with measurement & metering

| Cat.Nos | Nominal Rating | Number of 17.5 mm modules | MRP* ₹ / Unit | Pack |
|---------|----------------|---------------------------|---------------|------|
|---------|----------------|---------------------------|---------------|------|

Conform to IEC 61009-1
 Hpi type: detect faults with AC and DC components, increased
 Immunity to false tripping
 Inbuilt measurement/metering option
 Measurement - V, A, F, PF, KWh, KVA, KVAr, THD
 Metering - V, A, F, KWh
 RS 485 port for remote reading
 Di-electric test button inbuilt
 Ergonomic test button
 Scroll button for easy readings
 RLCD display on front facia
 For mounting on the right-hand side of 1.5 module per pole DX³ MCBs
 Easy & fast association mechanism
 70 sq mm terminals

Adjustable metering, four pole 415 V

| | | | | |
|---------|-------|---|-------|---|
| 4106 57 | 63 A | 7 | 14872 | 1 |
| 4106 58 | 125 A | 7 | 27260 | 1 |

Adjustable measurement

| | | | | |
|---------|-------|---|-------|---|
| 4106 59 | 125 A | 7 | 30022 | 1 |
|---------|-------|---|-------|---|

DX³ time switches

| Cat.Nos | Description | MRP* ₹ / Unit | Pack |
|---------|-------------|---------------|------|
|---------|-------------|---------------|------|

Time switches

Alpharex³ digital time switches

Daily and weekly time switch
 Quick and easy programming due to the option to select day blocks, day blocks can be individually set or selected from the blocks Mon-Sun, Mon-Fri or Sat-Sun
 Programming with precision to the second
 Switch times visible in weekly overview on display

| | | | |
|---------|---------------------------------------|------|---|
| 4126 31 | AlphaRex ³ D21, 1 channel | 4646 | 1 |
| 4126 41 | AlphaRex ³ D22, 2 channels | 6968 | 1 |
| 4126 34 | AlphaRex ³ D21s, 1 channel | 5524 | 1 |

Alpharex³ digital time switches - Astro

- For switching on/off lights and other electric devices according to the rising/setting of the sun
- With combination function for creating switching programs in which the devices are switched according to astronomical time and/or fixed preset times
- Daily astronomical calculation of the sunrise/sunset times based on the entered location or location coordinates

| | | | |
|---------|---|-------|---|
| 4126 54 | AlphaRex ³ D21 astro, 1 channel | 9294 | 1 |
| 4126 57 | AlphaRex ³ D22 astro, 2 channels | 10688 | 1 |

Alpharex³ yearly time switch

- Yearly and weekly time switch with additional astronomical function for all channels
- 84 switching programs per channel, comprising:
 - 28 weekly programs
 - 28 yearly programs
 - 28 special programs (priority program)

| | | | |
|---------|--|-------|---|
| 4126 29 | AlphaRex ³ DY21, 1 channel | 25324 | 1 |
| 4126 30 | AlphaRex ³ DY22, 2 channels | 26050 | 1 |

* MRP - Maximum Retail Price Inclusive of all taxes including GST.



4106 57



4126 41



4126 54



4126 57



4126 29



4128 12



4128 14



4125 44

DX³ time switches

| Cat.Nos | Description | MRP* ₹ / Unit | Pack |
|---------|-------------|---------------|------|
|---------|-------------|---------------|------|

Programming accessories

| | | | |
|---------|-------------------------|------|---|
| 4128 72 | Data key | 1352 | 1 |
| 4128 73 | PC adapter for USB port | 4604 | 1 |

Twilight switches

- Including light sensor
- Wire for light sensor: 2 x 1.5 mm², maximum wire length: 50 m
- LED switching status indicator

| | | | |
|---------|-------------|------|---|
| 4126 23 | Luxo switch | 6270 | 1 |
|---------|-------------|------|---|

MicroRex analog time switches

In accordance with IEC 60730-1 and 60730-2-7
 Manual switching ON/automatic/OFF
 Hourly/daily/weekly switching dial with captive segments
 Clock precision: +/- 5 min for the daily time switch
 -10 °C to +55 °C operating temperature

| | | | |
|---------|---|------|---|
| 4128 23 | MicroRex T31 Su/Wi - Daily time switch | 5862 | 1 |
| 4128 28 | MicroRex W31 Su/Wi - Weekly time switch | 6272 | 1 |

MicroRex analog time switches

| | | | |
|---------|------------------------------------|------|---|
| 4128 12 | MicroRex T31 - Daily time switch | 4690 | 1 |
| 4128 13 | MicroRex QT31 - Daily time switch | 5260 | 1 |
| 4128 14 | MicroRex W31 - Weekly time switch | 5630 | 1 |
| 4127 90 | MicroRex QT11 - Daily time switch | 3284 | 1 |
| 4127 94 | MicroRex QW11 - Weekly time switch | 3790 | 1 |

Accessory

| | | | |
|---------|--------------|-----|---|
| 4128 59 | Wall bracket | 984 | 1 |
|---------|--------------|-----|---|

DX³ contactors

Power contactors CX³

Conform to IEC/EN 61095

Space for power supply busbar on top (up to 25 A)

| | | | |
|---------|---------------------|------|---|
| 4125 44 | 25 A 2 NO contactor | 1870 | 1 |
| 4125 45 | 40 A 2 NO contactor | 3196 | 1 |
| 4125 47 | 63 A 2 NO contactor | 3716 | 1 |
| 4125 48 | 63 A 2 NC contactor | 3716 | 1 |
| 4125 49 | 40 A 3 NO contactor | 5342 | 1 |
| 4125 50 | 63 A 3 NO contactor | 6042 | 1 |
| 4125 51 | 25 A 4 NO contactor | 2208 | 1 |
| 4125 53 | 40 A 4 NO contactor | 5636 | 1 |
| 4125 56 | 63 A 4 NO contactor | 6674 | 1 |
| 4125 57 | 63 A 4 NC contactor | 6738 | 1 |

Signalling auxiliaries for contactors

Auxiliary changeover switch

| | | | |
|---------|--------------------------------------|------|---|
| 4124 29 | For 1 module contactors 16 A to 25 A | 2822 | 1 |
| 4124 30 | For 2 module contactors 25 A | 2832 | 1 |
| 4124 31 | For 40 and 63 A contactors | 3716 | 1 |

Bold Cat.Nos are products normally available with Legrand (India) Stockists. Cat.Nos that are not bold - delivery within 4 - 8 weeks from the date of order. Bold packing quantity is our mandatory packing. Orders to be placed by Legrand (India) Stockist in multiples of the same.

DX³ for photovoltaic applications

| Cat.Nos | Description | MRP* ₹ / Unit | Pack |
|---------|-------------|------------------|------|
|---------|-------------|------------------|------|

DC MCBs

Breaking capacity 4.5 kA according to EN 60947-2

800 V_{DC} circuit breakers

| | | | |
|---------|------|---|---|
| 4144 24 | 6 A | ■ | 1 |
| 4144 25 | 8 A | ■ | 1 |
| 4144 26 | 10 A | ■ | 1 |
| 4144 27 | 13 A | ■ | 1 |
| 4144 28 | 16 A | ■ | 1 |
| 4144 29 | 20 A | ■ | 1 |

1000 V_{DC} circuit breakers

| | | | |
|---------|------|---|---|
| 4144 46 | 10 A | ■ | 1 |
| 4144 47 | 13 A | ■ | 1 |
| 4144 48 | 16 A | ■ | 1 |
| 4144 49 | 20 A | ■ | 1 |
| 4144 50 | 25 A | ■ | 1 |
| 4144 51 | 32 A | ■ | 1 |

Type 2 voltage surge protectors

DC side protection of photovoltaic installations connected to the low voltage network (without energy storage system)
Conforming to UTE guide C 61-740-51
Protection in common mode and residual current mode (Y mode) 1
Consisting of plug-in modules with LED indicator
Red: modules need to be replaced

Voltage surge protectors

| | | | |
|---------|------------------------------|---|---|
| 4141 60 | 600 V= 25KA I _{max} | ■ | 1 |
| 4141 51 | 1000 V 40KA I _{max} | ■ | 1 |

Plug-in replacement module

| | | | |
|---------|--|---|---|
| 4141 90 | +/- cassette for voltage surge protector 4141 60 | ■ | 1 |
| 4141 91 | T cassette for voltage surge protector 4141 60 | ■ | 1 |
| 4141 81 | +/- and T cassette for voltage surge protector 4141 51 | ■ | 1 |

DC rotary handle isolating switches

Category of use DC 21B according to EN 60947-3
Double break contacts

600 V_{DC} isolating switches

| | | | |
|---------|------|---|---|
| 4142 61 | 16 A | ■ | 1 |
| 4142 62 | 25 A | ■ | 1 |
| 4142 63 | 32 A | ■ | 1 |

1000 V_{DC} isolating switches

| | | | |
|---------|------|---|---|
| 4142 81 | 16 A | ■ | 1 |
| 4142 82 | 25 A | ■ | 1 |
| 4142 83 | 32 A | ■ | 1 |

Accessories

| | | | |
|---------|-------------------------|---|----|
| 4063 05 | Pole separation divider | ■ | 1 |
| 4063 07 | Spacing unit 0.5 unit | ■ | 10 |

■ Price available on request.

* MRP - Maximum Retail Price Inclusive of all taxes including GST.

¹ 1P+N and 3P+N: L-N and N-PE protection modes (common and differential modes), the N pole being protected by encapsulated spark gaps. Also called sometimes 1+1 and 3+1

² Replaced mid 2015 by Cat.No 4122 80



4122 57



4122 83



4123 03



4122 84

Class I (T1) low voltage SPDs

| Cat.Nos | Number of poles | Neutral position | Rated current (I _{cn}) | Remoted discharging module (RDM) contact | Number of modules | MRP* ₹ / Unit | Pack |
|---------|-----------------|------------------|----------------------------------|--|-------------------|------------------|------|
|---------|-----------------|------------------|----------------------------------|--|-------------------|------------------|------|

SPDs for general protection of main distribution board

T1+T2 - limp 12,5 kA/pole T2 - 60 kA

| | | | | | | | |
|----------------------|------|-------|---------|-----|---|-------|---|
| 4122 70 | 1P | - | 12.5 kA | No | 1 | 7526 | 1 |
| 4122 76 ¹ | 1P+N | Right | 25 kA | Yes | 2 | 15050 | 1 |
| 4122 71 | 2P | - | 25 kA | No | 2 | 14536 | 1 |
| 4122 72 | 3P | - | 37.5 kA | Yes | 3 | 20478 | 1 |
| 4122 77 ¹ | 3P+N | Right | 50 kA | Yes | 4 | 27438 | 1 |
| 4122 73 | 4P | - | 50 kA | No | 4 | 25116 | 1 |

T1+T2 - limp 8 kA/pole T2 - 60 kA

| | | | | | | | |
|----------------------|------|-------|-------|----|---|-------|---|
| 4122 50 | 1P | - | 8 kA | No | 1 | 7146 | 1 |
| 4122 56 ¹ | 1P+N | Right | 16 kA | No | 2 | 12996 | 1 |
| 4122 51 | 2P | - | 16 kA | No | 2 | 13806 | 1 |
| 4122 52 | 3P | - | 25 kA | No | 3 | 19452 | 1 |
| 4122 57 ¹ | 3P+N | Right | 25 kA | No | 4 | 23640 | 1 |
| 4122 53 | 4P | - | 32 kA | No | 4 | 25054 | 1 |

SPDs for high risk level installations

T1 - limp 50 kA/pole - 440 V_~ (IT) - Monobloc

| | | | | | | | |
|----------------------|----|---|-------|----|---|------|---|
| 0030 00 ² | 1P | - | 50 kA | No | 2 | 7464 | 1 |
|----------------------|----|---|-------|----|---|------|---|

T1 - limp 35 kA/pole - 440 V_± (IT) - Plug-in

| | | | | | | | |
|---------|----|---|-------|-----|---|------|---|
| 4122 80 | 1P | - | 35 kA | Yes | 2 | 6664 | 1 |
|---------|----|---|-------|-----|---|------|---|

T1 - limp 25 kA/pole

| | | | | | | | |
|----------------------|------|-------|--------|-----|---|-------|---|
| 4122 81 ¹ | 1P+N | Right | 50 kA | Yes | 4 | 8658 | 1 |
| 4122 82 | 3P | - | 75 kA | Yes | 6 | 45000 | 1 |
| 4122 83 ¹ | 3P+N | Right | 100 kA | Yes | 8 | 49498 | 1 |

Replacement plug-in modules

| Cat.Nos | Description | MRP* ₹ / Unit | Pack |
|---------|-------------|------------------|------|
|---------|-------------|------------------|------|

| | | | |
|---------|---|-------|---|
| 4123 02 | For SPDs T1+T2 - 8 kA Cat.Nos 4122 50/ 51/52/53/56/57 | 5972 | 1 |
| 4123 03 | For SPDs T1+T2 - 12.5 kA Cat.Nos 4122 70/ 71/72/73/76/77 | 5632 | 1 |
| 4122 84 | For SPDs T1 - 25 kA Cat.Nos 4122 81/82/83 and 0030 20/22/23/27 | 16212 | 1 |
| 4122 85 | N-PE module for SPDs T1 - 25 kA Cat.Nos 4122 81/83 and 0030 23 | 22002 | 1 |
| 4122 86 | For SPDs T1 - 35 kA Cat.No 4122 80 | 5438 | 1 |

Cabling accessories

| | | | |
|---------|--|------|---|
| 4123 10 | Ready to use cabling kit consisting of 5 conductors (including the earth conductor) Cross section :16 mm ² Length : 40 cm For cabling SPDs in industrial enclosures (for EN/IEC 61439 compliance). | 1164 | 1 |
|---------|--|------|---|

Bold Cat.Nos are products normally available with Legrand (India) Stockists. Cat.Nos that are not bold - delivery within 4 - 8 weeks from the date of order. Bold packing quantity is our mandatory packing. Orders to be placed by Legrand (India) Stockist in multiples of the same.

Class II (T2) low voltage SPDs

| Cat.Nos | Number of poles | Neutral position | Remote status monitoring (FS contact) | Number of modules | MRP* ₹ / Unit | Pack |
|---------|-----------------|------------------|---------------------------------------|-------------------|------------------|------|
|---------|-----------------|------------------|---------------------------------------|-------------------|------------------|------|

T2 SPDs

T2 - I_{max} 40 kA/pole

| | | | | | | |
|----------------------|------|-------|-----|---|-------|---|
| 4122 40 | 1P | - | No | 1 | 5164 | 1 |
| 4122 46 ¹ | 1P+N | Right | No | 2 | 9832 | 1 |
| 4122 41 | 2P | - | No | 2 | 9832 | 1 |
| 4122 42 | 3P | - | Yes | 3 | 14400 | 1 |
| 4122 47 ¹ | 3P+N | Right | No | 4 | 17526 | 1 |
| 4122 43 | 4P | - | No | 4 | 17526 | 1 |



4122 43

T2 - I_{max} 40 kA/pole - 440 V_~ (IT)

| | | | | | | |
|---------|----|---|-----|---|-------|---|
| 4122 30 | 1P | - | No | 1 | 6838 | 1 |
| 4122 32 | 3P | - | Yes | 3 | 20478 | 1 |
| 4122 33 | 4P | - | Yes | 4 | 25116 | 1 |

T2 - I_{max} 20 kA/pole

| | | | | | | |
|----------------------|------|-------|----|---|-------|---|
| 4122 20 | 1P | - | No | 1 | 3528 | 1 |
| 4122 26 ¹ | 1P+N | Right | No | 2 | 7692 | 1 |
| 4122 21 | 2P | - | No | 2 | 7692 | 1 |
| 4122 27 ¹ | 3P+N | Right | No | 4 | 14320 | 1 |
| 4122 23 | 4P | - | No | 4 | 14320 | 1 |

Replacement plug-in modules

| Cat.Nos | Description | MRP* ₹ / Unit | Pack |
|---------|-------------|------------------|------|
|---------|-------------|------------------|------|

| | | | |
|---------|---|------|---|
| 4122 99 | For SPDs T2 - 40 kA Cat.Nos 4122 40/ 41/42/43/44/45/ 46/47/66/67 | 3844 | 1 |
| 4123 00 | N-PE module for SPDs T2 - 40 kA Cat.Nos 4122 46/47 | 7692 | 1 |
| 4123 01 | For SPDs T2 - 440 V Cat.Nos 4122 30/32/33 | 5916 | 1 |
| 4122 97 | For SPDs T2 - 20 kA Cat.Nos 4122 20/ 21/23/26/27/62/63 | 2906 | 1 |
| 4123 98 | N-PE module for SPDs T2 - 20 kA Cat.Nos 4122 24/25/26/27 | 6428 | 1 |



4122 99



0039 51



0039 53



0039 54



0038 28



0038 29



4129 00



6040 22

Class II (T2) low voltage SPDs with integrated protection

| Cat.Nos | Number of poles | Neutral position | Integrated protection | Number of modules | MRP* ₹ / Unit | Pack |
|---------|-----------------|------------------|-----------------------|-------------------|------------------|------|
|---------|-----------------|------------------|-----------------------|-------------------|------------------|------|

Protection for consumer units

T2 self protected SPDs - I_{max} 12 kA/pole

| | | | | | | |
|----------------------|------|------|------------------------|---|-------|---|
| 0039 51 ¹ | 1P+N | Left | I _{sc} ≤ 6 kA | 2 | 9970 | 1 |
| 0039 53 ¹ | 3P+N | Left | I _{sc} ≤ 6 kA | 6 | 21750 | 1 |

Protection for secondary distribution boards

T2 self protected SPDs - I_{max} 12 kA/pole

| | | | | | | |
|----------------------|------|------|-------------------------|---|-------|---|
| 0039 71 ¹ | 1P+N | Left | I _{sc} ≤ 10 kA | 2 | 8254 | 1 |
| 0039 73 ¹ | 3P+N | Left | I _{sc} ≤ 10 kA | 6 | 15614 | 1 |

Replacement plug-in modules

| Cat.Nos | Description | MRP* ₹ / Unit | Pack |
|---------|-------------|------------------|------|
|---------|-------------|------------------|------|

For self protected SPDs

| | | | |
|---------|-----------------------|------|---|
| 0039 54 | Cat.Nos 0039 51/53 | 6470 | 1 |
| 0039 74 | Cat.Nos 0039 71/73 | 6692 | 1 |

SPDs for telephone lines

| Cat.Nos | In/I _{max} | Max. voltage (Uc) | Level of protection (Up) | No. of modules | MRP* ₹ / Unit | Pack |
|---------|---------------------|-------------------|--------------------------|----------------|------------------|------|
|---------|---------------------|-------------------|--------------------------|----------------|------------------|------|

SPDs for telephone and data lines

"Analogue" SPD (STN, non-unbundled ADSL, etc.)

| | | | | | | |
|---------|---------|-------|-------|---|-------|---|
| 0038 28 | 5/10 kA | 170 V | 260 V | 1 | 12282 | 1 |
|---------|---------|-------|-------|---|-------|---|

"Digital" SPD (unbundled ADSL, SDSL, ISDN, etc.)

| | | | | | | |
|---------|---------|------|-------|---|-------|---|
| 0038 29 | 5/10 kA | 48 V | 100 V | 1 | 12262 | 1 |
|---------|---------|------|-------|---|-------|---|

DX³ changeover switches

| Cat.Nos | Description | MRP* ₹ / Unit | Pack |
|---------|-------------|------------------|------|
|---------|-------------|------------------|------|

Changeover Switches

Single pole - two way - 250 V AC

| | | | |
|---------|------|------|--------|
| 4129 00 | 32 A | 3082 | 10/100 |
|---------|------|------|--------|

Double pole - two way - 400 V AC

| | | | |
|---------|------|------|------|
| 4129 01 | 32 A | 3082 | 5/50 |
|---------|------|------|------|

Double pole - two way with centre off - 400 V AC

| | | | |
|---------|------|------|------|
| 4129 03 | 32 A | 3228 | 5/50 |
|---------|------|------|------|

Four pole - two way with centre off - 400 V AC

| | | | |
|---------|------|------|------|
| 6040 22 | 40 A | 4878 | 2/20 |
|---------|------|------|------|

* MRP - Maximum Retail Price Inclusive of all taxes including GST.

¹ 1P+N and 3P+N: L-N and N-PE protection modes (common and differential modes), the N pole being protected by encapsulated spark gaps. Also called sometimes 1+1 and 3+1

Bold Cat.Nos are products normally available with Legrand (India) Stockists. Cat.Nos that are not bold - delivery within 4 - 8 weeks from the date of order. Bold packing quantity is our mandatory packing. Orders to be placed by Legrand (India) Stockist in multiples of the same.

ACCL

AUTOMATIC CHANGEOVER WITH CURRENT LIMITER

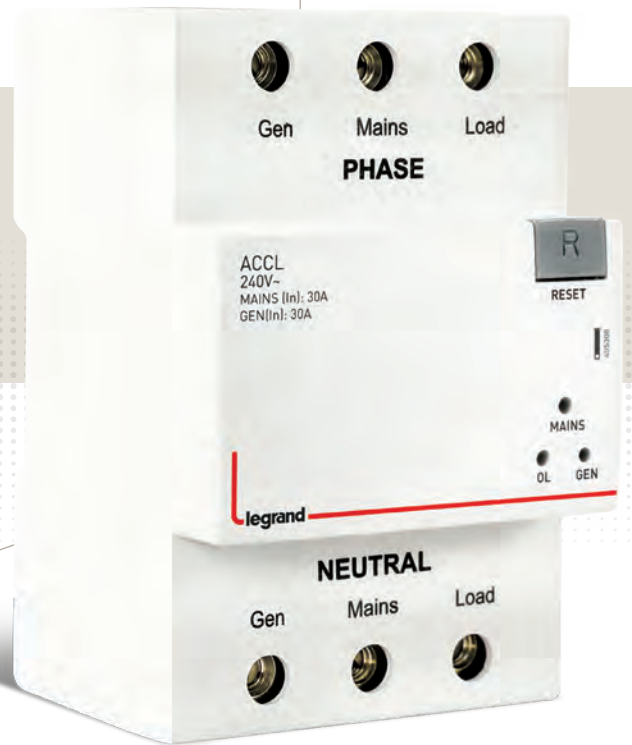

Seamless and uninterrupted switchover for smart spaces

- Intelligent micro-controller based design
- Automatic source change over between Mains & Generator supply
- Manual reset for restoring supply in sleep mode
- Break before make change over system
- Direct mount on DIN rail channel
- Buzzer and LED light indication of status-Overload, Mains, Gen
- Current limitation function prevents over loading of the generator
- Neutral isolation

Automatic changeover with current limiter(ACCL)

| Cat.Nos | Description | MRP* ₹ / Unit | Pack |
|---------|-------------|------------------|------|
|---------|-------------|------------------|------|

Automatic changeover with current limiter(ACCL)

Intelligent micro controller based design
Automatic source change over between Mains & Generator supply
Break before make change over system
Buzzer and Led Indication of status
Current limitation prevents overloading of the generator

NEW!

| | | | |
|---------|------------|------|------|
| 4053 00 | SPN 30/3A | 1990 | 1/15 |
| 4053 01 | SPN 30/4A | 1990 | 1/15 |
| 4053 02 | SPN 30/5A | 1990 | 1/15 |
| 4053 03 | SPN 30/6A | 1990 | 1/15 |
| 4053 04 | SPN 30/9A | 1990 | 1/15 |
| 4053 05 | SPN 30/12A | 1990 | 1/15 |
| 4053 06 | SPN 30/15A | 1990 | 1/15 |
| 4053 07 | SPN 30/20A | 1990 | 1/15 |
| 4053 08 | SPN 30/30A | 1990 | 1/15 |

DX³ push button

Push button cum switch

Push button cum switch - 1 module - 20 A-250 V AC

Single function

| Cat.Nos | Description | MRP* ₹ / Unit | Pack |
|---------|-----------------|------------------|--------|
| 4129 08 | Contact 1 NO | 2688 | 10/100 |
| 4129 09 | Contact 1 NC | 2688 | 10/60 |
| 4129 10 | Contact 2 NO | 2688 | 10/60 |

Dual function

| | | | |
|---------|-------------------------------------|------|--------|
| 4129 14 | Contact - 1 NO + green indicator | 2688 | 10/100 |
| 4129 15 | Contact - 1 NC + red indicator | 2688 | 10/60 |

DX³ indicators

Single indicators - 1 module - 250 V AC

Possible to replace E10 lamps and diffusers.
E10 - 1.2 Watt, 230 V AC

| | | | |
|---------|-------------------------------------|------|--------|
| 4129 26 | Colour - Green | 674 | 10/100 |
| 4129 27 | Colour - Red | 674 | 10/100 |
| 4129 28 | Colour - Orange | 674 | 10/100 |
| 4129 29 | Colour - Blue | 674 | 10/100 |
| 4129 32 | White + White + White | 1344 | 10/100 |
| 4129 33 | Red + Red + Red time delay relay | 1344 | 10/100 |
| 4129 34 | Red + Yellow + Green | 1826 | 10/100 |
| 4129 35 | Red + Yellow + Blue | 1344 | 10/100 |

Lexic dimmer

Dimmer

1000 W remote dimmer

| | | | |
|---------|---|-------|------|
| 0036 71 | 1000 W universal remote control dimmer 6 module | 39155 | 1/10 |
|---------|---|-------|------|

Lexic time switches

Multifunction time delay relay

- Supply voltage : 12 to 230 V AC 50/60 Hz and DC
- Output : 8 A - 250 V AC, $\cos\phi = 1$
- Contact NO

| | | | |
|---------|-----------------------------------|-------|---|
| 0047 44 | Multifunction time delay relay | 12878 | 1 |
|---------|-----------------------------------|-------|---|

* MRP - Maximum Retail Price Inclusive of all taxes including GST.

Rex modular time switches

| Cat.Nos | Description | MRP* ₹ / Unit | Pack |
|---------|-------------|------------------|------|
|---------|-------------|------------------|------|

Time lag switch

| | | | |
|---------|---|------|--------|
| 0047 02 | Time lag switch long time (1 module) | 6706 | 10/100 |
|---------|---|------|--------|

Rex surface mounting time switches

MaxiRex

| | | | |
|----------|---|------|------|
| 6499 15 | MaxiRex 4QT (daily) | 5370 | 1/30 |
| 6499 14A | MaxiRex 4QTB (daily with IP 53 box) | 6198 | 1 |
| 6499 39 | MaxiRex 5QW (weekly) | 6298 | 1/30 |
| 6499 36A | MaxiRex 4QWB (weekly with IP 53 box) | 6828 | 1 |

EconoRex

| | | | |
|---------|------------------------|------|------|
| 0499 86 | EconoRex MQT (24 hrs.) | 5652 | 1/30 |
|---------|------------------------|------|------|

Accessories

| | | | |
|---------|---|-----|------|
| 0498 32 | Clip on support frame for facia mounting of MaxiRex QTT and QWT | 344 | 1/5 |
| 0044 09 | DIN rail adaptor for MaxiRex QTT and QWT | 262 | 1 |
| 0044 07 | DIN rail adaptor for EconoRex BQTAP | 252 | 1 |
| 6499 49 | Terminal cover for 4/5 nominal time switch | 290 | 1/30 |
| 6499 48 | IP53 box for MaxiRex 4 and 5 | 882 | 1/10 |

Current transformers

- Used with ammeters, electricity meters
- Supply a current of 5 A to the secondary which is proportional to the primary current.
- Fix to plate or rail EN 60715

| | | | |
|---------|---|------|------|
| 4121 01 | 50/5 Precision in % - 1 Power in VA - 1.5 | 2614 | 1/12 |
| 4121 03 | 100/5 Precision in % - 1 Power in VA - 1.5 | 3490 | 1/12 |
| 4121 06 | 200/5 Precision in % - 0.5 Power in VA - 4 | 3490 | 1/12 |
| 4121 24 | 300/5 Precision in % - 0.5 Power in VA - 5 | 3490 | 1/12 |
| 4121 25 | 400/5 Precision in % - 0.5 Power in VA - 8 | 3616 | 1/12 |
| 4121 36 | 600/5 Precision in % - 0.5 Power in VA - 12 | 3668 | 1/12 |
| 4121 38 | 800/5 Precision in % - 0.5 Power in VA - 8 | 5374 | 1/12 |
| 4121 39 | 1000/5 Precision in % - 0.5 Power in VA - 10 | 5678 | 1/12 |
| 4121 42 | 1250/5 Precision in % - 0.5 Power in VA - 12 | 6624 | 1/12 |

Bold Cat.Nos are products normally available with Legrand (India) Stockists. Cat.Nos that are not bold - delivery within 4 - 8 weeks from the date of order. Bold packing quantity is our mandatory packing. Orders to be placed by Legrand (India) Stockist in multiples of the same.

EKINOX³

REINVENTED ENERGY DISTRIBUTION

Ekinox³ is an experience unlike any other. Imagine a distribution board built with incredible features which keep you away from the worry of constantly maintaining it. Ekinox³ is designed to work as beautifully as it looks.



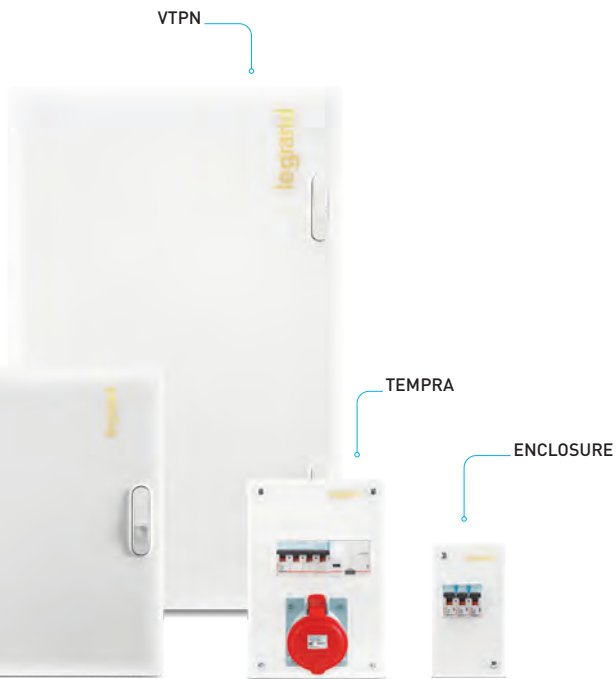

EKINOX³

MIVAN CONSTRUCTION COMPATIBLE EKINOX³ DB



Mivan Construction Compatible Ekinox3 distribution boards are made with thick sheets to withstand extreme pressures during the Mivan construction process. The sleek, minimalistic and stylish design enhance the overall ambience of the spaces.

SALIENT FEATURES

Easily removable knock outs for cable glanding

Full proof solution

Innovative door knob

Integrated door earthing system

Door separately packed

Plain look with rounded corners

Stronger glanding plates

Nut inserts for longer installation life

Increased sheet thickness to withstand Mivan Construction challenges

Slimmest DB with 71 mm depth

IP 43 degree of protection

Wire set, Din rail components, Neutral and Earth bar packed separately in inner assembly set

Ekinox³ ETPN DB's

for DX³ MCB, Isolator, RCCB and RCBO

| Cat.Nos | Number of ways | No. of modules | MRP* ₹ / Unit | Pack |
|---------|----------------|----------------|------------------|------|
|---------|----------------|----------------|------------------|------|

- As per IEC 61439-3
- Suitable for Flush Mounting and Surface Mounting
- With 100 A Copper Busbar
- With Neutral bar, Earthbar and Cable ties for Cable management
- Fully shrouded Neutral bars
- Prefitted masking sheet
- Reversible Door for IP 43 & IP 54 DB's

IP 30 - #IK 08

| | | | | |
|---------|--------|----|------|---|
| 5076 00 | 4 way | 4 | 1260 | 1 |
| 5076 01 | 8 way | 8 | 1582 | 1 |
| 5076 02 | 12 way | 12 | 1872 | 1 |
| 5076 03 | 16 way | 16 | 2308 | 1 |
| 5076 04 | 18 way | 18 | 2688 | 1 |
| 5076 05 | 20 way | 20 | 2760 | 1 |

IP 43 - #IK 09 with metal door

| | | | | |
|---------|--------|----|------|---|
| 5076 10 | 4 way | 4 | 1694 | 1 |
| 5076 11 | 8 way | 8 | 2102 | 1 |
| 5076 12 | 12 way | 12 | 2524 | 1 |
| 5076 13 | 16 way | 16 | 3168 | 1 |
| 5076 14 | 18 way | 18 | 3230 | 1 |
| 5076 15 | 20 way | 20 | 3918 | 1 |

IP 43 - #IK 09 with acrylic door

| | | | | |
|---------|--------|----|------|---|
| 5076 20 | 4 way | 4 | 2202 | 1 |
| 5076 21 | 8 way | 8 | 2550 | 1 |
| 5076 22 | 12 way | 12 | 3098 | 1 |
| 5076 23 | 16 way | 16 | 3850 | 1 |
| 5076 24 | 18 way | 18 | 4224 | 1 |
| 5076 25 | 20 way | 20 | 4516 | 1 |

IP 54 - #IK 09

| | | | | |
|---------|--------|----|------|---|
| 5076 40 | 4 way | 4 | 5784 | 1 |
| 5076 41 | 8 way | 8 | 6800 | 1 |
| 5076 42 | 12 way | 12 | 7810 | 1 |
| 5076 43 | 16 way | 16 | 8690 | 1 |
| 5076 44 | 18 way | 18 | 9130 | 1 |
| 5076 45 | 20 way | 20 | 9642 | 1 |

Ekinox³ ETPN DB's

for DX³ MCB, Isolator, RCCB and RCBO

- As per IEC 61439-3
- Suitable for Flush Mounting and Surface Mounting
- With 100 A Copper Busbar for each phase
- With Neutral bar, Earthbar and Cable ties for Cable management
- Fully insulated busbar & shrouded Neutral bars
- Improved Pan assembly for ease of installation
- Prefitted masking sheet
- Reversible Door for IP 43 & IP 54 DB's
- With provision for FP MCB/Isolator/RCCB/RCBO as incomer and SP MCB's as outgoing
- Supplied with wireset
- Can be converted to PPI DB at site using conversion kit

IP 30 - #IK 08

| | | | | |
|---------|--------|------|-------|---|
| 5076 60 | 4 way | 8+12 | 3482 | 1 |
| 5076 61 | 6 way | 8+18 | 4296 | 1 |
| 5076 62 | 8 way | 8+24 | 5050 | 1 |
| 5076 63 | 12 way | 8+36 | 7482 | 1 |
| 5076 64 | 16 way | 8+48 | 9222 | 1 |
| 5076 66 | 20 way | 8+60 | 12868 | 1 |

* MRP - Maximum Retail Price Inclusive of all taxes including GST.
#IK - Refer pg - 59 for ready reckoner table.

Ekinox³ ETPN DB's

for DX³ MCB, Isolator, RCCB and RCBO

| Cat.Nos | Number of ways | No. of modules | MRP* ₹ / Unit | Pack |
|---------|----------------|----------------|------------------|------|
|---------|----------------|----------------|------------------|------|

IP 43 - #IK 09 with metal door

| | | | | |
|---------|--------|------|-------|---|
| 5076 70 | 4 way | 8+12 | 4138 | 1 |
| 5076 71 | 6 way | 8+18 | 5104 | 1 |
| 5076 72 | 8 way | 8+24 | 6122 | 1 |
| 5076 73 | 12 way | 8+36 | 9170 | 1 |
| 5076 74 | 16 way | 8+48 | 11368 | 1 |
| 5076 76 | 20 way | 8+60 | 15914 | 1 |

IP 43 - #IK 09 with acrylic door

| | | | | |
|---------|--------|------|-------|---|
| 5076 80 | 4 way | 8+12 | 5484 | 1 |
| 5076 81 | 6 way | 8+18 | 6772 | 1 |
| 5076 82 | 8 way | 8+24 | 8124 | 1 |
| 5076 83 | 12 way | 8+36 | 12462 | 1 |
| 5076 84 | 16 way | 8+48 | 14952 | 1 |
| 5076 86 | 20 way | 8+60 | 20930 | 1 |

IP 54 - #IK 09

| | | | | |
|---------|--------|------|-------|---|
| 5076 90 | 4 way | 8+12 | 13782 | 1 |
| 5076 91 | 6 way | 8+18 | 16584 | 1 |
| 5076 92 | 8 way | 8+24 | 18138 | 1 |
| 5076 93 | 12 way | 8+36 | 25562 | 1 |
| 5076 94 | 16 way | 8+48 | 30676 | 1 |
| 5076 96 | 20 way | 8+60 | 38382 | 1 |

Ekinox³ Flexy DB

for DX³ DIN modular products

| Cat.Nos | Number of row | No. of modules | MRP* ₹ / Unit | Pack |
|---------|---------------|----------------|------------------|------|
|---------|---------------|----------------|------------------|------|

- As per IEC 61439-3
- Suitable for Flush Mounting and Surface Mounting
- Completely flexible to organise the distribution as per site requirements
- Busbars to be selected as per distribution requirements
- With Neutral and Earth bars
- Fully shrouded Neutral bars
- Improved Pan assembly for ease of installation
- Prefitted masking sheet
- Reversible door for IP 43

IP 30 - #K 08

| | | | | |
|---------|---------------|----|------|---|
| 5077 01 | 2 row of 14 M | 28 | 4454 | 1 |
| 5077 02 | 3 row of 14 M | 42 | 5346 | 1 |
| 5077 03 | 4 row of 14 M | 56 | 6124 | 1 |

IP 43 - #IK 09 with metal door

| | | | | |
|---------|--|----|------|---|
| 5077 05 | 2 row of 14 M | 28 | 5252 | 1 |
| 5077 06 | 3 row of 14 M | 42 | 6308 | 1 |
| 5077 07 | 4 row of 14 M | 56 | 6872 | 1 |
| 5077 14 | 4 row of 8 M | 32 | 5468 | 1 |
| 5077 15 | 4 row of 10 M | 40 | 5670 | 1 |
| 5077 12 | 3 row of 14 M MCCB for DPX ³ 160 MCCB | 42 | 6870 | 1 |

IP 43 - #IK 09 with acrylic door

| | | | | |
|---------|--|----|------|---|
| 5077 09 | 2 row of 14 M | 28 | 5608 | 1 |
| 5077 10 | 3 row of 14 M | 42 | 6878 | 1 |
| 5077 11 | 4 row of 14 M | 56 | 7792 | 1 |
| 5077 13 | 3 row of 14 M MCCB for DPX ³ 160 MCCB | 42 | 8100 | 1 |

Bold Cat.Nos are products normally available with Legrand (India) Stockists.
Cat.Nos that are not bold - delivery within 4 - 8 weeks from the date of order.
Bold packing quantity is our mandatory packing. Orders to be placed by Legrand (India) Stockist in multiples of the same.

Ekinox³ TPN DB-VTPN DPX³ 160 MCCB DB's

| Cat.Nos | Number of ways | No. of modules | MRP* ₹ / Unit | Pack |
|---------|----------------|----------------|------------------|------|
|---------|----------------|----------------|------------------|------|

- As per IEC 61439-3
- Suitable for Flush Mounting and Surface Mounting
- With 100 A Copper Busbar for each phase
- With 2 Neutral bar, 2 Earthbar and Cable ties for Cable management
- Fully insulated busbar & shrouded Neutral bars
- Improved Pan assembly for ease of installation
- Prefitted masking sheet
- Reversible Door for IP 43 & IP 54 DB's
- With provision for FP MCB/Isolator/RCCB/RCBO as incomer and SP/TP MCB's as outgoing



5077 20

IP 30 - #IK 08

| | | | | |
|---------|--------|------|-------|---|
| 5077 20 | 4 way | 8+12 | 9804 | 1 |
| 5077 21 | 6 way | 8+18 | 10782 | 1 |
| 5077 22 | 8 way | 8+24 | 11968 | 1 |
| 5077 23 | 12 way | 8+36 | 17282 | 1 |

IP 43 - #IK 09 with metal door

| | | | | |
|---------|--------|------|-------|---|
| 5077 25 | 4 way | 8+12 | 10304 | 1 |
| 5077 26 | 6 way | 8+18 | 11336 | 1 |
| 5077 27 | 8 way | 8+24 | 13106 | 1 |
| 5077 28 | 12 way | 8+36 | 17804 | 1 |

IP 43 - #IK 09 with acrylic door

| | | | | |
|---------|--------|------|-------|---|
| 5077 30 | 4 way | 8+12 | 14092 | 1 |
| 5077 31 | 6 way | 8+18 | 15500 | 1 |
| 5077 32 | 8 way | 8+24 | 17914 | 1 |
| 5077 33 | 12 way | 8+36 | 23900 | 1 |



5077 31

IP 54 - #IK 09

| | | | | |
|---------|--------|------|-------|---|
| 5077 35 | 4 way | 8+12 | 22320 | 1 |
| 5077 36 | 6 way | 8+18 | 24556 | 1 |
| 5077 37 | 8 way | 8+24 | 26848 | 1 |
| 5077 38 | 12 way | 8+36 | 35096 | 1 |



5076 61

Ekinox³ TPN DB-VTPN DPX³ 160 MCCB DB's

- As per IEC 61439-3
- Suitable for Flush Mounting and Surface Mounting
- With 250 A Copper Busbar for each phase
- With 2 Neutral bar, 2 Earthbar and Cable ties for Cable management
- Fully insulated busbar & shrouded Neutral bars
- Improved Pan assembly for ease of installation
- Prefitted masking sheet
- Reversible Door for IP 43 & IP 54 DB's
- With provision for DPX³ 160 MCCB as incomer and SP/TP MCB's as outgoing

IP 30 - #IK 08

| | | | | |
|---------|--------|-------------------------|-------|---|
| 5077 40 | 4 way | DPX ³ 160+12 | 11196 | 1 |
| 5077 41 | 6 way | DPX ³ 160+18 | 12092 | 1 |
| 5077 42 | 8 way | DPX ³ 160+24 | 13250 | 1 |
| 5077 43 | 12 way | DPX ³ 160+36 | 20032 | 1 |

IP 43 - #IK 09 with metal door

| | | | | |
|---------|--------|-------------------------|-------|---|
| 5077 45 | 4 way | DPX ³ 160+12 | 12298 | 1 |
| 5077 46 | 6 way | DPX ³ 160+18 | 13972 | 1 |
| 5077 47 | 8 way | DPX ³ 160+24 | 15378 | 1 |
| 5077 48 | 12 way | DPX ³ 160+36 | 20964 | 1 |



5077 81

* MRP - Maximum Retail Price Inclusive of all taxes including GST.
#IK - Refer pg - 59 for ready reckoner table.

Ekinox³ TPN DB-VTPN DPX³ 160 MCCB DB's

| Cat.Nos | Number of ways | No. of modules | MRP* ₹ / Unit | Pack |
|---------|----------------|----------------|------------------|------|
|---------|----------------|----------------|------------------|------|

IP 54 - #IK 09

| | | | | |
|---------|--------|-------------------------|-------|---|
| 5077 50 | 4 way | DPX ³ 160+12 | 25686 | 1 |
| 5077 51 | 6 way | DPX ³ 160+18 | 29536 | 1 |
| 5077 52 | 8 way | DPX ³ 160+24 | 30876 | 1 |
| 5077 53 | 12 way | DPX ³ 160+36 | 40674 | 1 |

Ekinox³ TPN DB-VTPN DPX³ 250 MCCB DB's

- As per IEC 61439-3
- Suitable for Flush Mounting and Surface Mounting
- With 250 A Copper Busbar for each phase
- With 2 Neutral bar, 2 Earthbar and Cable ties for Cable management
- Fully insulated busbar & shrouded Neutral bars
- Improved Pan assembly for ease of installation
- Prefitted masking sheet
- Reversible Door for IP 43 & IP 54 DB's
- With provision for DPX³ 250 MCCB as incomer and SP/TP MCB's as outgoing

IP 30 - #IK 08

| | | | | |
|---------|--------|-------------------------|-------|---|
| 5077 55 | 4 way | DPX ³ 250+12 | 20394 | 1 |
| 5077 56 | 8 way | DPX ³ 250+24 | 21894 | 1 |
| 5077 57 | 12 way | DPX ³ 250+36 | 24400 | 1 |

IP 43 - #IK 09 with metal door

| | | | | |
|---------|--------|-------------------------|-------|---|
| 5077 58 | 4 way | DPX ³ 250+12 | 22768 | 1 |
| 5077 59 | 8 way | DPX ³ 250+24 | 26584 | 1 |
| 5077 60 | 12 way | DPX ³ 250+36 | 28020 | 1 |

IP 54 - #IK 09

| | | | | |
|---------|--------|-------------------------|-------|---|
| 5077 61 | 4 way | DPX ³ 250+12 | 36214 | 1 |
| 5077 62 | 8 way | DPX ³ 250+24 | 40900 | 1 |
| 5077 63 | 12 way | DPX ³ 250+36 | 47890 | 1 |

Ekinox³ TPN DB-Phase selector DB's for DX³ MCB, Isolator, RCCB and RCBO

- As per IEC 61439-3
- With inbuilt 3 nos of 63 A Phase selector switches and 3 Nos Piano Switches
- Suitable for Flush Mounting and Surface Mounting
- With 100 A Copper Busbar for each phase
- With Neutral bar, Earthbar and Cable ties for Cable management
- Fully insulated busbar & shrouded Neutral bars
- With provision for FP MCB/Isolator/RCCB/RCBO as incomer and SP MCB's as outgoing
- Supplied with wire set

IP 30 - #IK 08

| | | | | |
|---------|--------|------|-------|---|
| 5077 70 | 4 way | 8+12 | 13176 | 1 |
| 5077 71 | 6 way | 8+18 | 14014 | 1 |
| 5077 72 | 8 way | 8+24 | 15526 | 1 |
| 5077 73 | 12 way | 8+36 | 17194 | 1 |

IP 43 - #IK 09 with metal door

| | | | | |
|---------|--------|------|-------|---|
| 5077 80 | 4 way | 8+12 | 14252 | 1 |
| 5077 81 | 6 way | 8+18 | 14480 | 1 |
| 5077 82 | 8 way | 8+24 | 15514 | 1 |
| | 12 way | 8+36 | 17464 | 1 |

Bold Cat.Nos are products normally available with Legrand (India) Stockists.
Cat.Nos that are not bold - delivery within 4 - 8 weeks from the date of order.
Bold packing quantity is our mandatory packing. Orders to be placed by Legrand (India) Stockist in multiples of the same.

Ekinox³ TPN DB - 7 segment DB's for DX³ MCB, Isolator, RCCB and RCBO

| Cat.Nos | Number of ways | No. of modules | MRP* ₹ / Unit | Pack |
|---------|----------------|----------------|------------------|------|
|---------|----------------|----------------|------------------|------|

- As per IEC 61439-3
- Separate compartment for incomer, sub-incomer & outgoing devices
- Suitable for Flush Mounting and Surface Mounting
- With 100 A Copper Busbar for each phase
- With Neutral bar, Earthbar and Cable ties for Cable management
- Fully insulated busbar & shrouded Neutral bars
- With provision for FP MCB/Isolator/RCCB/RCBO as incomer, DP RCCB/RCBO as sub incomer and SP MCB's as outgoing
- Supplied with wire set
- DB with phase segmentation and separation between incomer and outgoing

IP 30 - #IK 08

| | | | | |
|---------|--------|---------|-------|---|
| 5078 80 | 4 way | 8+12+12 | 9752 | 1 |
| 5078 81 | 6 way | 8+12+18 | 10380 | 1 |
| 5078 82 | 8 way | 8+12+24 | 11280 | 1 |
| 5078 83 | 12 way | 8+12+36 | 12982 | 1 |

IP 43 - #IK 09 with metal door

| | | | | |
|---------|--------|---------|-------|---|
| 5078 85 | 4 way | 8+12+12 | 10646 | 1 |
| 5078 86 | 6 way | 8+12+18 | 11990 | 1 |
| 5078 87 | 8 way | 8+12+24 | 13388 | 1 |
| 5078 88 | 12 way | 8+12+36 | 16646 | 1 |

Ekinox³ TPN DB - 7 segment DB's for 160 A DPX³ MCCB

- As per IEC 61439-3
- DB with phase segmentation and separation between incomer and Outgoings
- Suitable for Flush Mounting and Surface Mounting
- With 100 A Copper Busbar for each phase
- With Neutral bar, Earthbar and Cable ties for Cable management
- Fully Color Shrouded Insulated bus bar and Neutral bars
- With provision for DPX³ 160 MCCB as incomer DP MCB/ Isolator/RCCB/RCBO as sub incomers and SP MCB's as outgoing
- Supplied with wire set

IP 30 - #IK 08

| | | | | |
|---------|--------|-------------------------------|-------|---|
| 5078 90 | 4 way | DPX ³ 160+12+12 | 13800 | 1 |
| 5078 91 | 6 way | DPX ³ 160+12+18 | 15878 | 1 |
| 5078 92 | 8 way | DPX ³ 160+12+24 | 18246 | 1 |
| 5078 93 | 12 way | DPX ³ 160+12+36 | 21184 | 1 |

* MRP - Maximum Retail Price Inclusive of all taxes including GST.
#IK - Refer pg - 59 for ready reckoner table.

Ekinox³ TPN DB - 7 segment DB's for 160 A DPX³ MCCB

| Cat.Nos | Number of ways | No. of modules | MRP* ₹ / Unit | Pack |
|---------|----------------|----------------|------------------|------|
|---------|----------------|----------------|------------------|------|

IP 43 - #IK 09 with metal door

| | | | | |
|---------|--------|-------------------------------|-------|---|
| 5078 95 | 4 way | DPX ³ 160+12+12 | 15196 | 1 |
| 5078 96 | 6 way | DPX ³ 160+12+18 | 17394 | 1 |
| 5078 97 | 8 way | DPX ³ 160+12+24 | 19916 | 1 |
| 5078 98 | 12 way | DPX ³ 160+12+36 | 22684 | 1 |

Ekinox³ Metra plug & socket DB's for DX³ MCB, RCCB and RCBO

| Cat.Nos | Description | No. of modules | MRP* ₹ / Unit | Pack |
|---------|-------------|----------------|------------------|------|
|---------|-------------|----------------|------------------|------|

- As per IEC 61439-3
- Suitable for Flush Mounting and Surface Mounting
- Suitable for protection of appliances like AC/Geyser etc
- Supplied with Neutral Links
- With provision for mounting modular devices

#IK 08

| | | | | |
|---------|-----------------------|---|------|---|
| 5078 10 | 10 A SP, 2P+E | 1 | 1658 | 1 |
| 5078 11 | 20 A SP, 2P+E | 1 | 1786 | 1 |
| 5078 14 | 20 A DP, 2P+E | 2 | 1940 | 1 |
| 5078 17 | 20 A TP, 3P+E | 3 | 3290 | 1 |
| 5078 18 | 32 A TP, 3P+E | 3 | 3902 | 1 |
| 5078 20 | 20 A DP RCBO, 2P+E | 4 | 1878 | 1 |
| 5078 21 | 20 A FP RCBO, 2P+E | 8 | 3284 | 1 |
| 5078 22 | 32 A FP RCBO, 3P+E | 8 | 3872 | 1 |

Ekinox³ P-17 Tempra plug & socket DB's for DX³ MCB, RCCB and RCBO

- As per IEC 61439-3
- Suitable for Flush Mounting and Surface Mounting
- Supplied with Neutral Links
- With provision for mounting modular devices

#IK 08

| | | | | |
|---------|-------------------|---|-------|---|
| 5078 60 | 16 A 2P+E-DP | 2 | 2738 | 1 |
| 5078 63 | 32 A 2P+E-DP | 2 | 2954 | 1 |
| 5078 61 | 32 A 3P+E-FP | 8 | 4950 | 1 |
| 5078 62 | 32 A 3P+N+E-FP | 8 | 4960 | 1 |
| 5078 64 | 63 A 3P+N+E-FP | 8 | 12344 | 1 |

Bold Cat.Nos are products normally available with Legrand (India) Stockists.
Cat.Nos that are not bold - delivery within 4 - 8 weeks from the date of order.
Bold packing quantity is our mandatory packing. Orders to be placed by Legrand (India) Stockist in multiples of the same.

Ekinox³ Metal enclosures

for DX³ MCB, RCCB, RCBO and DPX³ MCCB's

| Cat.Nos | Discription | No. of modules | MRP* ₹ / Unit | Pack |
|---------|-------------|----------------|---------------|------|
|---------|-------------|----------------|---------------|------|

- As per IEC 61439-3
- For independent mounting of DX³ MCB, RCCB, RCBO, DPX³ 160, DPX³ 250, DPX³ 630 & DRX MCCB's
- #IK 08

#IK 08

| | | | | |
|---------|-------------------|---|------|---|
| 5077 90 | SP enclosure | 1 | 450 | 1 |
| 5077 91 | DP enclosure | 2 | 656 | 1 |
| 5077 92 | TP enclosure | 3 | 656 | 1 |
| 5077 93 | FP enclosure | 4 | 656 | 1 |
| 5077 94 | FP RCBO enclosure | 8 | 1108 | 1 |

Metal one way enclosures for MCCB

| | | | | |
|---------|-------------------------------------|-----|------|---|
| 5078 01 | DPX ³ 160 MCCB enclosure | 3&4 | 3690 | 1 |
| 5078 02 | DPX ³ 250 MCCB enclosure | 3&4 | 6554 | 1 |
| 5078 04 | DPX ³ 630 MCCB enclosure | 3&4 | 9936 | 1 |
| 5078 05 | DRX 100 MCCB enclosure-TP | 3 | 1972 | 1 |
| 5078 06 | DRX 100 MCCB enclosure-FP | 4 | 1972 | 1 |

Ekinox³ cable end box

| Cat.Nos | Discription | MRP* ₹ / Unit | Pack |
|---------|-------------|---------------|------|
|---------|-------------|---------------|------|

- Useful for keeping extra cables
- Possible to mount on the top or bottom of the DB
- Provision for mounting terminal blocks
- Can be used as a terminal box adaptor also

For IP 30 DB's

| | | | |
|---------|-------------------------------|------|---|
| 5079 10 | For SPN 4 W IP30 | 638 | 1 |
| 5079 12 | For SPN 8 W IP30 | 742 | 1 |
| 5079 14 | For SPN 12 W/ VTPN/Flexy | 822 | 1 |
| 5079 16 | For SPN 16 W/ ETPN 6 way DB | 1158 | 1 |
| 5079 25 | For ETPN 8 way DB | 2070 | 1 |
| 5079 27 | For ETPN 12 way DB | 2758 | 1 |
| 5079 29 | For ETPN 16 way DB | 2758 | 1 |
| 5079 31 | For ETPN 18 way DB | 3136 | 1 |
| 5079 33 | For ETPN 20 way DB | 3032 | 1 |
| 5079 35 | For ETPN 4 way VTPN/FLEXY MCB | 822 | 1 |
| 5079 37 | For all VTPN MCCB DBS | 3048 | 1 |

For IP 43 DB's

| | | | |
|---------|-------------------------------|-----|---|
| 5079 11 | For SPN 4 way DB | 742 | 1 |
| 5079 13 | For SPN 8 way DB | 854 | 1 |
| 5079 15 | For SPN 12 way/ VTPN/Flexy DB | 958 | 1 |

* MRP - Maximum Retail Price Inclusive of all taxes including GST.
#IK - Refer pg - 59 for ready reckoner table.

Ekinox³ cable end box

| Cat.Nos | Discription | MRP* ₹ / Unit | Pack |
|---------|-------------|---------------|------|
|---------|-------------|---------------|------|

For IP 43 DB's

| | | | |
|---------|--------------------------------|------|---|
| 5079 17 | For SPN 16 way/ ETPN 6 way DB | 1358 | 1 |
| 5079 18 | For SPN 18 way DB | 1388 | 1 |
| 5079 19 | For SPN 20/ETPN 8 way DB | 1422 | 1 |
| 5079 28 | For ETPN 12 way DB | 3168 | 1 |
| 5079 30 | For ETPN 16 way DB | 3168 | 1 |
| 5079 32 | For ETPN 18 way DB | 3600 | 1 |
| 5079 34 | For ETPN 20 way DB | 3482 | 1 |
| 5079 36 | For all ETPN 4W/VTPN/Flexy MCB | 958 | 1 |
| 5079 38 | For all VTPN MCCB DBs | 3432 | 1 |
| 5079 00 | For 7 segment 4 way DB | 3324 | 1 |
| 5079 01 | For 7 segment 6 way DB | 3646 | 1 |
| 5079 02 | For 7 segment 8 way DB | 4068 | 1 |
| 5079 03 | For 7 segment 12 way DB | 4596 | 1 |

Ekinox³ DBs

meter box

- Suitable for Mounting DX³ Metering products
- Possible to mount on the top or bottom of the DB
- Provision for mounting Ammeter/Voltmeter/ASS/VSS
- #IK09

Provision for mounting meters

| | | | |
|---------|---------------------------|------|---|
| 5079 40 | For VTPN MCB INCOM IP 30 | 4150 | 1 |
| 5079 41 | For VTPN MCB INCOM IP 43 | 4984 | 1 |
| 5079 42 | For VTPN MCCB INCOM IP 30 | 4614 | 1 |
| 5079 43 | For VTPN MCCB INCOM IP 43 | 5536 | 1 |

Per phase Isolation kit

| | | | |
|---------|---------------------------------------|------|---|
| 5079 44 | PPI conversion kit for ETPN 4 way DB | 2360 | 1 |
| 5079 45 | PPI conversion kit for ETPN 6 way DB | 2660 | 1 |
| 5079 46 | PPI conversion kit for ETPN 8 way DB | 3078 | 1 |
| 5079 47 | PPI conversion kit for ETPN 12 way DB | 3432 | 1 |
| 5079 48 | PPI conversion kit for ETPN 16 way DB | 3854 | 1 |

Panel locks

| | | | |
|---------|----------------------|-----|---|
| 5079 52 | Panel knob for IP 43 | 272 | 1 |
| 5079 51 | Panel knob with key | 574 | 1 |

Bold Cat.Nos are products normally available with Legrand (India) Stockists. Cat.Nos that are not bold - delivery within 4 - 8 weeks from the date of order. Bold packing quantity is our mandatory packing. Orders to be placed by Legrand (India) Stockist in multiples of the same.

Ekinox™ distribution boards

| Cat.Nos | Number of ways | MRP* ₹ / Unit | Pack |
|---------|----------------|------------------|------|
|---------|----------------|------------------|------|

Plexo³ boxes for DX³

Self-extinguishing: resistance to incandescent wire 650 °C

Conform to EN 60439-3

Weatherproof cabinets - IP 65 - IK 09 - Class II

Door and cabinet fully reversible

Removable chassis and faceplates from 2-row versions up

2-position rail for modular products and moulded cases

Spacing between rails 150 mm

Box colour light grey L750A, cover colour dark grey R746A



6019 94

| | | | |
|---------|---------------|------|---|
| 6019 32 | 2 (+1) Module | 1630 | 1 |
| 6019 94 | 4 Module | 1736 | 1 |
| 6019 96 | 6 Module | 1990 | 1 |
| 6019 98 | 8 Module | 2488 | 1 |

Cabinets with 12 modules per row



6018 32

| | | | |
|---------|-------------------|------|---|
| 6018 31 | 1 row 12 modules | 3920 | 1 |
| 6018 32 | 2 rows 24 modules | 5436 | 1 |
| 6018 33 | 3 rows 36 modules | 7576 | 1 |

Cabinets with 18 modules per row

| | | | |
|---------|---------------------|-------|---|
| 6018 35 | 18 modules x 1 row | 4834 | 1 |
| 6018 36 | 18 modules x 2 rows | 8360 | 1 |
| 6018 37 | 18 modules x 3 rows | 11758 | 1 |
| 6018 38 | 18 modules x 4 rows | 18294 | 1 |

Multifunction sleeves for P17



6018 32 + 0019 17

| | | | |
|---------|--------------------|------|---|
| 0019 17 | For 2 row cabinets | 3168 | 1 |
| 0019 18 | For 3 row cabinets | 4750 | 1 |
| 0019 67 | Joining kit | 924 | 1 |



Ekinox³
reinvented
electrical safety

* MRP - Maximum Retail Price Inclusive of all taxes including GST.
Refer instruction manual for MIVAN (Aluminum shuttering) compatible DB's

Distribution boards

| Cat.Nos | No. of devices connected | No. of 17.5 mm modules | MRP* ₹ / Unit | Pack |
|---------|--------------------------|------------------------|------------------|------|
|---------|--------------------------|------------------------|------------------|------|

Supply busbars - insulated

63 A copper

Pin type

SP I/C & SP O/G

| | | | | |
|---------|----|----|------|---|
| 4049 26 | 13 | 13 | 320 | 1 |
| 4049 37 | 57 | 57 | 1242 | 1 |

SPN I/C & SPN O/G

| | | | | |
|---------|----|----|------|---|
| 4049 38 | 6 | 12 | 564 | 1 |
| 4049 39 | 28 | 56 | 2324 | 1 |

TPN I/C & SPN O/G

| | | | | |
|---------|----|----|------|------|
| 4049 40 | 5 | 12 | 582 | 3/30 |
| 4049 41 | 27 | 56 | 5678 | 5/10 |

TP I/C & TP O/G

| | | | | |
|---------|----|----|------|---|
| 4049 42 | 4 | 12 | 582 | 1 |
| 4049 43 | 19 | 57 | 5734 | 1 |

FP I/C & FP O/G

| | | | | |
|---------|----|----|------|------|
| 4049 44 | 3 | 12 | 1400 | 3/30 |
| 4049 45 | 14 | 56 | 5678 | 5/10 |

Fork type

SP I/C & SP O/G

| | | | | |
|---------|----|----|------|---|
| 4049 11 | 13 | 12 | 320 | 1 |
| 4049 12 | 57 | 57 | 1218 | 1 |

SPN I/C & SPN O/G250

| | | | | |
|---------|----|----|------|---|
| 4049 14 | 28 | 56 | 2324 | 1 |
|---------|----|----|------|---|

TP I/C & TP O/G

| | | | | |
|---------|----|----|------|---|
| 4049 17 | 4 | 12 | 582 | 1 |
| 4049 18 | 19 | 57 | 5678 | 1 |

FP I/C & FP O/G

| | | | | |
|---------|----|----|------|------|
| 4049 20 | 14 | 56 | 5678 | 5/10 |
|---------|----|----|------|------|

| Cat.Nos | Description | MRP* ₹ / Unit | Pack |
|---------|-------------|------------------|------|
|---------|-------------|------------------|------|

Accessories for fork and pin type busbars

| | | | |
|---------|----------------------|----|--------|
| 4049 89 | End caps for SP | 8 | 6 |
| 4049 90 | End caps for DP & TP | 36 | 6 |
| 4049 91 | End caps for FP | 70 | 20/840 |

| Cat.Nos | Number of ways | MRP* ₹ / Unit | Pack |
|---------|----------------|------------------|------|
|---------|----------------|------------------|------|

Blanking plates

| | | | |
|---------|---|----|----|
| 6014 70 | - | 14 | 10 |
|---------|---|----|----|

Bold Cat.Nos are products normally available with Legrand (India) Stockists. Cat.Nos that are not bold - delivery within 4 - 8 weeks from the date of order. Bold packing quantity is our mandatory packing. Orders to be placed by Legrand (India) Stockist in multiples of the same.

Ekinox³

For converting ETPN DB to PPI DB

PPI DB IP 30 - IK 08

| No. of ways | Combine | | No. of modules |
|-------------|------------------|----------------------|----------------|
| | ETPN DB | PPI Kit | |
| 4 way | 4 way 507660 | 4 way kit 507944 | 8+12 |
| 6 way | 6 way 507661 | 6 way kit 507945 | 8+18 |
| 8 way | 8 way 507662 | 8 way kit 507946 | 8+24 |
| 12 way | 12 way 507663 | 12 way kit 507947 | 8+36 |
| 16 way | 16 way 507664 | 16 way kit 507948 | 8+48 |

PPI DB IP 43 - IK 09 with metal door

| No. of ways | Combine | | No. of modules |
|-------------|------------------|----------------------|----------------|
| | ETPN DB | PPI Kit | |
| 4 way | 4 way 507670 | 4 way kit 507944 | 8+12 |
| 6 way | 6 way 507671 | 6 way kit 507945 | 8+18 |
| 8 way | 8 way 507672 | 8 way kit 507946 | 8+24 |
| 12 way | 12 way 507673 | 12 way kit 507947 | 8+36 |
| 16 way | 16 way 507674 | 16 way kit 507948 | 8+48 |

PPI DB IP 43 - IK 09 with acrylic door

| No. of ways | Combine | | No. of modules |
|-------------|------------------|----------------------|----------------|
| | ETPN DB | PPI Kit | |
| 4 way | 4 way 507680 | 4 way kit 507944 | 8+12 |
| 6 way | 6 way 507681 | 6 way kit 507945 | 8+18 |
| 8 way | 8 way 507682 | 8 way kit 507946 | 8+24 |
| 12 way | 12 way 507683 | 12 way kit 507947 | 8+36 |
| 16 way | 16 way 507684 | 16 way kit 507948 | 8+48 |

PPI DB IP 54 - IK 09

| No. of ways | Combine | | No. of modules |
|-------------|------------------|----------------------|----------------|
| | ETPN DB | PPI Kit | |
| 4 way | 4 way 507690 | 4 way kit 507944 | 8+12 |
| 6 way | 6 way 507691 | 6 way kit 507945 | 8+18 |
| 8 way | 8 way 507692 | 8 way kit 507946 | 8+24 |
| 12 way | 12 way 507693 | 12 way kit 507947 | 8+36 |
| 16 way | 16 way 507694 | 16 way kit 507948 | 8+48 |

IK

Protection against mechanical impact: protection index - IK

According to standard:

IEC 62262, BS EN 62262 and NF EN 62262

• This table can be used to ascertain the resistance of a product to an impact given in Joules from the IK code (graduated from 00 to 10)

It can also be used to ascertain the correspondence with the old IP code 3rd digit and the corresponding external "Ag" conditions

| IK | Tests | Impact energy (in Joules) | "AG" of NF C 15-100 |
|-------|-------|---------------------------|---------------------|
| IK 00 | | 0 | |
| IK 01 | | 0.15 | |
| IK 02 | | 0.2 | AG1 |
| IK 03 | | 0.35 | |
| IK 04 | | 0.5 | |
| IK 05 | | 0.7 | |
| IK 06 | | 1 | |
| IK 07 | | 2 | AG2 |
| IK 08 | | 5 | AG3 |
| IK 09 | | 10 | |
| IK 10 | | 20 | AG4 |

IPXX

Index of protection

IP*** index of protection of enclosures of electrical equipment in accordance with standards IEC 529, BS 5490, DIN 400 50 and NF C 20-010

Up to 1000 V± and 1500 V= (standard UTE C 20 010)

1st figure:- protection against solid bodies

| IP | tests | |
|----|-------|--|
| 0 | | No protection |
| 1 | | Protected against solid bodies larger than 50 mm (eg.: accidental contact with the hand) |
| 2 | | Protected against solid bodies larger than 12 mm (eg.: finger) |
| 3 | | Protected against solid bodies larger than 2.5 mm (eg.: tools, wires) |
| 4 | | Protected against solid bodies larger than 1 mm (eg.: fine tools and small wires) |
| 5 | | Protected against dust (no harmful deposit) |
| 6 | | Completely protected against dust |

2nd figure:- protection against liquids

| IP | tests | |
|----|-------|---|
| 0 | | No protection |
| 1 | | Protected against vertically-falling drops of water (condensation) |
| 2 | | Protected against drops of water falling at up to 15° from the vertical |
| 3 | | Protected against drops of rain water at up to 60° from the vertical |
| 4 | | Protected against projections of water from all directions |
| 5 | | Protected against jets of water from all directions |
| 6 | | Protected against jets of water of similar force to heavy seas |
| 7 | | Protected against the effects of immersion |
| 8 | | Protected against prolonged effects of immersion under pressure |

The contents of all the above charts are for guidance only, if you have any doubt as to the interpretation of the information contained therein, please refer either to the standard itself or contact Legrand.

In accordance with our policy of continuous improvement, Legrand reserves the right to change specifications and designs without notice. All information given here is correct at the time of going to press.

SUPER COMPACT (SCP)

THE POWER SOLUTIONS FOR INDUSTRIAL AND SERVICE SECTOR APPLICATION

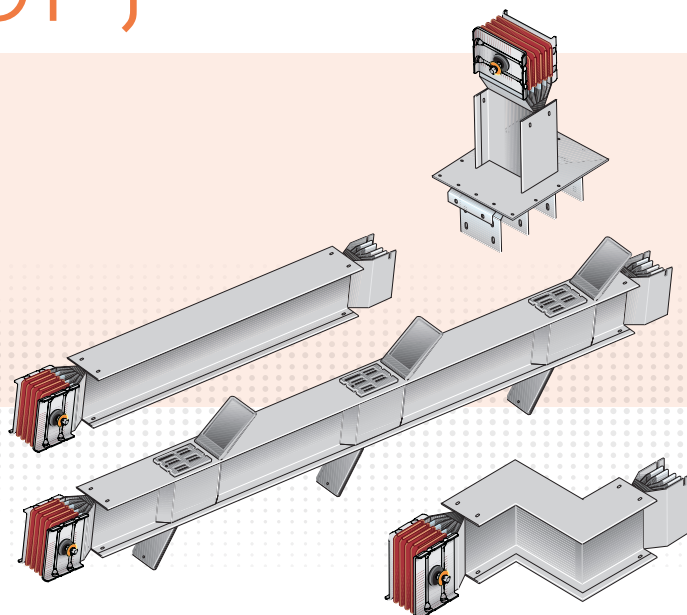

FEATURES

- Availability in the standard range from 630 A to 5000 A* with Aluminum alloy conductors and from 800 A to 6300 A* with copper conductors.
- Low impedance of the circuit;
- Availability with a wide selection of tap-off boxes that range from 63 A upto 1250 A, thus allowing you to locally protect and feed different types of loads by housing protective devices such as fuses, MCCBs and motorized switches.
- Compliance with the IES 61439-6 standard

ULTRA- COMPACT SIZES

- The super-compact dimensions enhance its resistance to short circuit stresses; in addition. They can reduce the impedance of the circuit by controlling the voltage drops and allow for the installation of high power electrical systems, even in extremely confined spaces.



Horizontal elbow



Vertical elbow



Connection interface

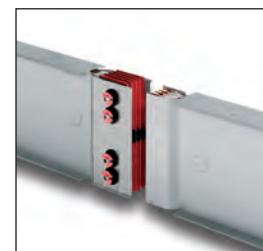

Junction

ARTEOR™

VERSATILITY AND A
GLOBAL VISION FOR ANY
INSTALLATION LEVEL



Arteor™ is the innovative answer to the increasingly complex requirements in the building business all over the world. Arteor™ excels by its unique aesthetics and a rich choice of innovative designs and ergonomical options.

The range extends from wiring devices, through innovative IoT based solutions, up to fully networked home automation systems based on BUS technology, which can also be integrated into third party solutions.



ARTEOR™

DESIGN FOR A GLOBAL LIFESTYLE



DESIGN OPTIONS FOR CONTROL FUNCTIONS

Arteor™ offers a wide choice of ergonomics and finishes to satisfy the most demanding customers. All stand-alone control functions are available in two shapes of rockers – round or square – and in three colours – white, magnesium and champagne.



Round rocker White



Round rocker Magnesium

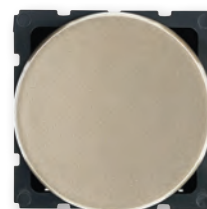

Round rocker Champagne



Square rocker White



Square rocker Magnesium



Square rocker Champagne



ARTEOR™

THE IDEAL SOLUTION,
ALWAYS AND
EVERYWHERE

Its versatility makes Arteor™ the ideal choice for every kind of project, anywhere in the world at any installation level. Arteor™ suits any requirement in terms of design and function for every kind of building, from residential to commercial.



Fan regulator



TV socket

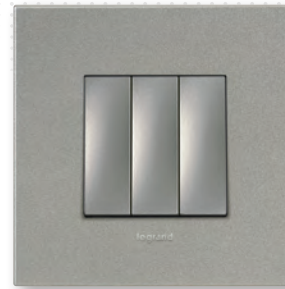

1-way switch - 3 gang



Bell push



Power unit



Switch & socket



Skirting light

HOME



MODERN HOME



6AX switch*



PIR Sensor



Triple RCA socket



Skirting light



USB charger



Time delay switch

*Switch compatible with LED light

ARTEOR™

OFFICE AND HOTEL SOLUTIONS

Offices and collective spaces require specific solutions and maximum flexibility: lighting adapted to each situation (meeting, conference, etc.), access security, comprehensive multimedia connections. The Arteor™ range meets all these expectations with perfect adaptability.



Automatic switch



6 A 1 way switch



Preterminated HDMI sockets



USB socket



RJ45



Female HD15 + Jack



Universal touch dimmer*



Universal dimmer*

OFFICE



*For all loads including LED

HOTEL



4-Scenario touch control



S-Video socket



Keycard switch



External unit



Desk and entrance light



TV/R/SAT



Internal unit



Bed light and curtain aswitch



Data sockets

From hotel room door to the beside table, Arteor™ provides all the solutions for the specific need of today's hotel industry. Comfort that extends to the hotel's communal areas, whether dedicated to the relaxation or work. The multitude of small details, gives the comfort feeling of being at home to the traveller.

ARTEOR™

A RICH CHOICE
OF FINISHES

NEUTRAL

White



Magnesium



MIRROR

Mirror Black



GRAPHIC

Casual



METAL

Stainless Steel



WOOD

Grey Oak



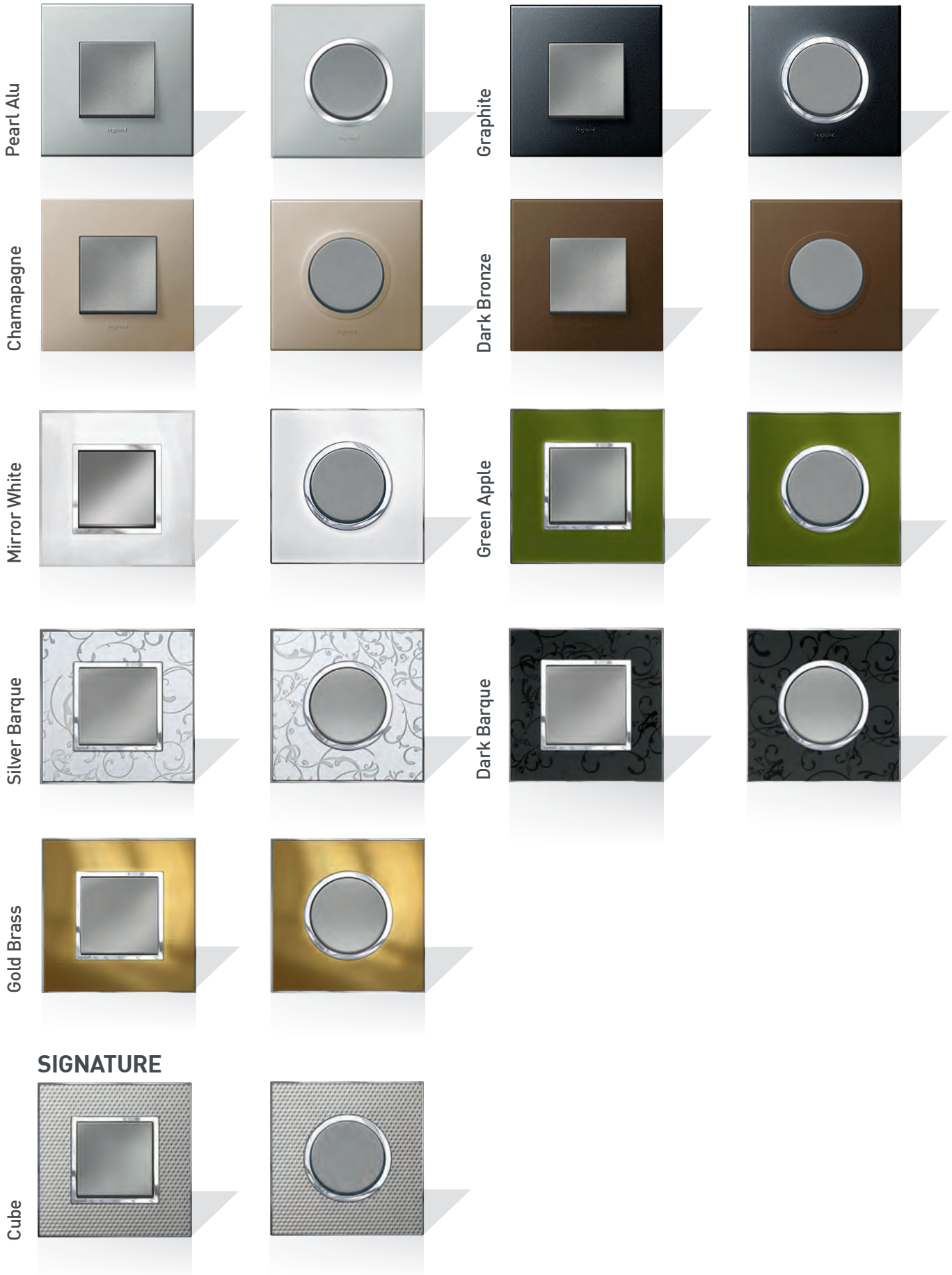

SIGNATURE

ARTEOR™

VERSATILITY AND
MODULARITY FOR
UNRIVALLED FLEXIBILITY

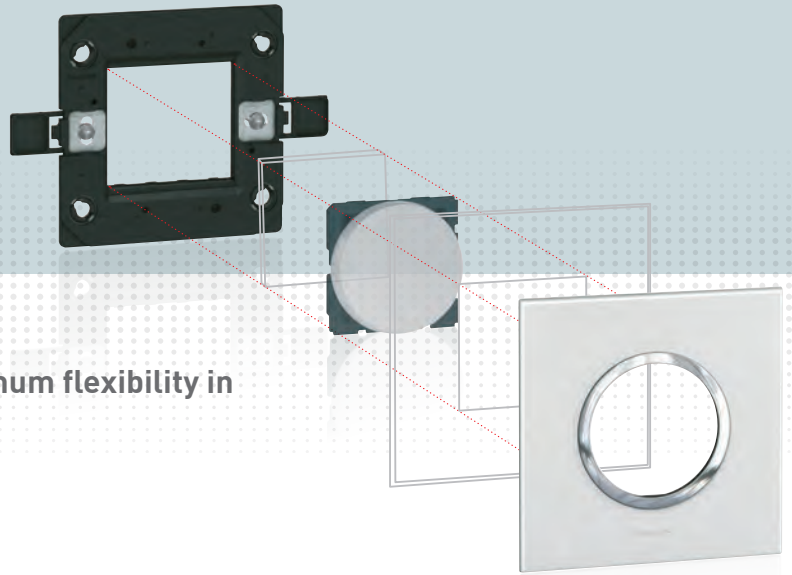

Arteor™ is a modular range offering maximum flexibility in terms of installation and configuration.

Protection at every step of the installation process

Support frames and plates are each supplied with special shrink wrap protection should be removed only once site work is fully completed.

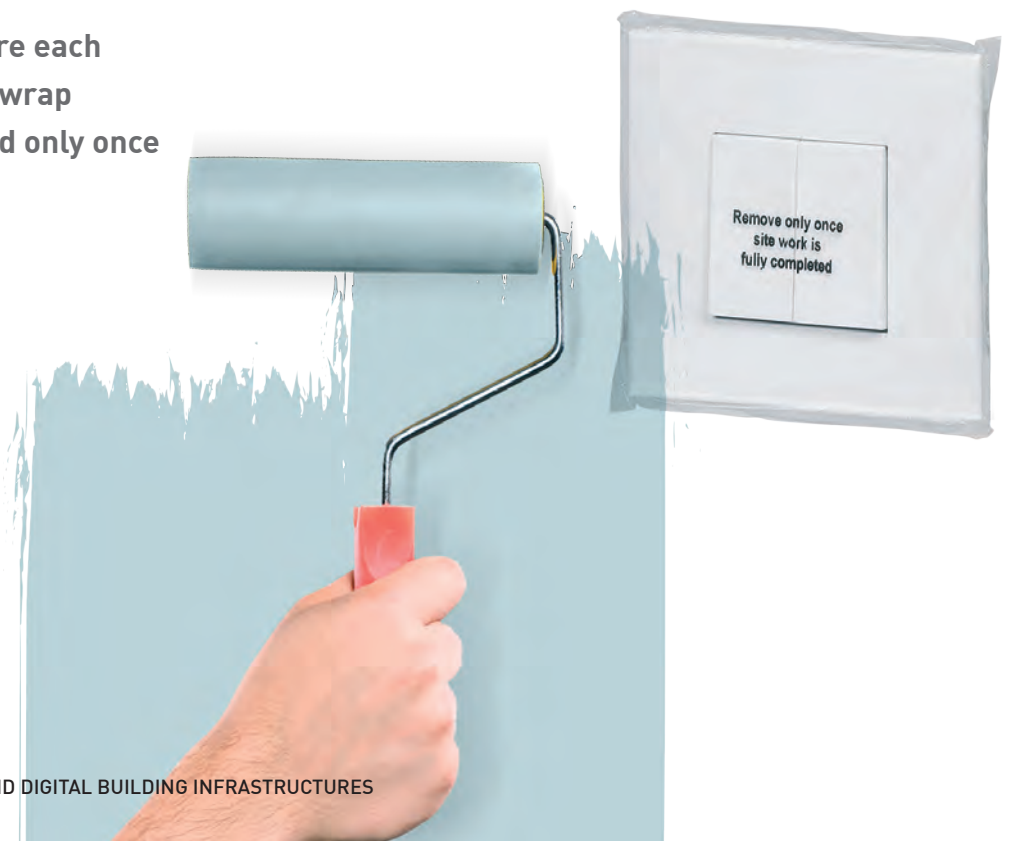

Features that set ARTEOR™ apart



- ① Finger-proof terminals for IP 20 protection against accidental contact.
- ② Captive "never to loose screws"



- ① Tunnel terminals preventing screwdrivers from slipping.
- ② Laser marking on mechanisms. Arrow showing the correct orientation of the mechanism.
- ③ The latest IS 3854 : 1997.



Sockets with ISI mark, conforming to IS 1293. Fan regulator with ISI mark, conforming to IS 11037.



Fully shrouded internal mechanism under the rocker preventing visibility of sparks.



- ① Stripping templates on sockets for stripping off exact length of insulation.



Sockets are shuttered for child's safety against electric shocks.



Possibility of weather proofing mechanisms using Plexo IP 55 and IP 66 boxes.



For switches with LED lamps, life of LED is 50000 burning hours. Consumes power (0.76W) next to NIL.

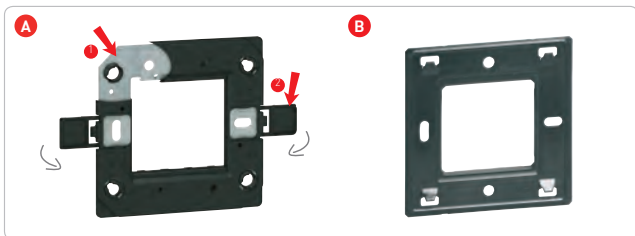

A. For all high end plates
Metal frame providing solid support to base.
Bi-material frame - electrical safety IP20.
Screw caps can be closed once the support frame is installed, ensuring total insulation.



2x2 way switch - 3 controls possible in 2 module plate. In round and square design possible.

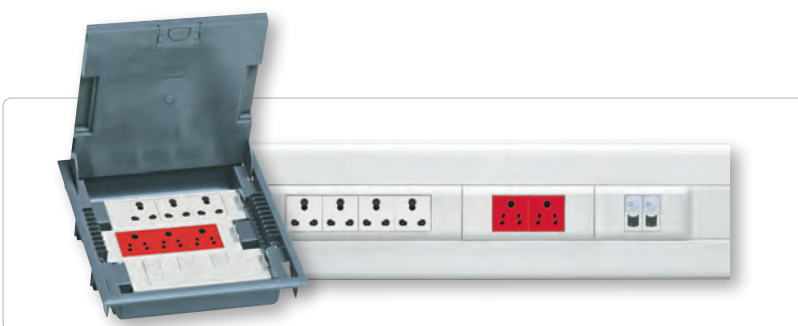

Mechanisms compatible with DLP trunking systems, columns, floor boxes and VDI installations.

ARTEOR™ IoT

ADD A TOUCH OF SMARTNESS

THE SMART RADIO SOLUTION

Arteor IoT offer, a radio-based solution for the connected home. The intelligent products communicate with one another via radio ZigBee 3.0 (2.4 GHz waveband). This means there is no need for specific or extensive cabling. Also, although the range only contains a few products, these can be used to create lots of individual solutions for a more customized feel at home.

SIMPLE, ADAPTABLE, OPEN

Radio-based Arteor has been designed and developed as a simple solution to make every house more individual, convenient and secure. Simple for planners, who are able to integrate many useful functions without having to provide for complicated cabling. Simple for installers, who are able to install the system without a great deal of effort or specialist knowledge. Simple for users, who will find it convenient to operate, easy to extend and are able to make changes at any time.



THE HOME + CONTROL APP FOR SMARTPHONE OR TABLET

The app on the smartphone or tablet opens up new options: monitoring of instantaneous power consumption, remote surveillance of the connected home, and control over various functions when the user is out and about.



LOCAL CONTROL GUARANTEED

Of course, all functions can still be used in the traditional way via switches on the wall. If furniture needs to be rearranged or small children need to be able to reach a switch, the wireless switches can be repositioned easily at any time.



Home + Control App

iPhone, iPod and iPad are registered trademarks of Apple Inc., registered in the US and other countries. HomeKit is a trademark of Apple Inc. App store is a service mark of Apple Inc., Google, Android, Google Play, and the Google Play logo are trademarks of Google LLC. Amazon, Alexa and all related logos are trademarks of Amazon.com, Inc. or its affiliates.

ARTEOR™ MyHOME_UP

THE BEAUTIFUL SIMPLICITY
OF HOME AUTOMATION

Put the finishing touch to your homes with the hometouch screen. get total control of your home with just a touch. see the full range of home automation solutions provided by arteor MyHOME_Up on legrand.co.in



THE FINISHING TOUCH



UX FOR UPSCALE HOTELS

FIVE STAR SOLUTION

Designed specifically for premium level establishments, UX for Upscale Hotels provides top quality solutions with its brand-new touchplates and enhanced functionalities. Operating on an open protocol, the guest room management system can seamlessly integrate with third party building management systems, thus raising hospitality to new heights across the world. In conjunction with Arteor or other Legrand wiring device ranges.



EXTERNAL READER

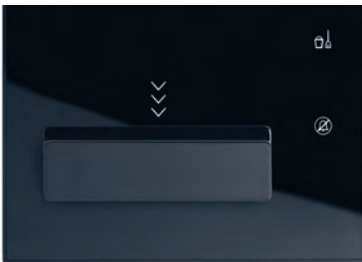

KEYCARD READER

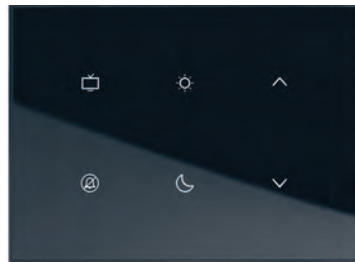

6-GANG TOUCH PLATE

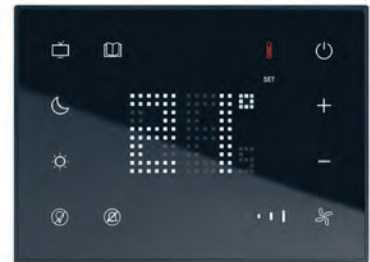

BEDSIDE PANEL



Arteor™ square - white mechanisms

| Cat.Nos | Description | MRP* ₹ / Unit | Pack |
|---------|-------------|------------------|------|
|---------|-------------|------------------|------|

Switches – 6 A - 250 V AC

| | | | |
|---------|--|-----|--------|
| 5734 00 | Switch - 6 A - SP - 1 way 1 module | 174 | 20/200 |
| 5734 01 | Switch - 6 A - SP - 1 way with indicator - 1 module | 270 | 20/200 |
| 5734 02 | Switch - 6 A - SP - 2 way 1 module | 240 | 20/200 |
| 5734 03 | Switch - 6 A - SP - 2 way with indicator - 1 module | 340 | 20/200 |

Switches – 10 A - 250 V AC

| | | | |
|---------|---|------|--------|
| 5734 50 | Switch - 10 A - SP - 1 way 2 module | 278 | 10/100 |
| 5734 51 | Switch - 10 A - SP - 2 way 2 module | 328 | 10/100 |
| 5720 37 | Switch - 10 A - SP - 2 way with indicator & label holder - 2 module | 1554 | 10/100 |
| 5720 38 | Intermediate switch - 2 module | 1858 | 10/100 |

Switches – 20 A - 250 V AC

| | | | |
|---------|---|-----|--------|
| 5734 10 | Switch - 20 A - SP - 1 way - 1 module | 316 | 20/200 |
| 5734 52 | Switch - 20 A - SP - 1 way - 2 module | 378 | 10/100 |
| 5720 63 | Switch - 20 A - SP - 1 way with indicator - 1 module | 326 | 20/200 |
| 5734 11 | Switch - 20 A - SP - 2 way with indicator - 1 module | 456 | 20/200 |
| 5720 42 | Switch - 20 A - SP - 2 way with indicator - 2 module | 496 | 10/100 |
| 5720 43 | Switch - 20 A - 3 gang - 1 way - 2 module | 892 | 10/100 |
| 5720 44 | Switch - 20 A - 3 gang - 2x2 way + 1x1 way - 2 module | 976 | 10/100 |
| 5734 54 | Switch - 20 A - DP - 1 way with indicator - 2 module | 702 | 10/100 |
| 5720 49 | Switch - 20 A - DP - 1 way with indicator and water heater marking - 2 module | 738 | 10/100 |

Accessory for switch with indicator

| | | | |
|---------|---|----|------|
| 5738 06 | LED for switch with indicator (blue) | 56 | 5/50 |
| 5738 05 | LED for switch with indicator (red) | 48 | 5/50 |

Switches – 25 A - 230 V AC

| | | | |
|---------|----------------------------|-----|--------|
| 5734 17 | 25 A switch with indicator | 424 | 20/200 |
|---------|----------------------------|-----|--------|

Switches – 32 A / 40 A - 250 V AC

| | | | |
|---------|--|------|--------|
| 5734 12 | Switch - 32 A - DP - 1 way with indicator - 2 module | 1000 | 10/100 |
| 5735 30 | Switch - 40 A - DP - 1 way with indicator - fits on 1/2 module box | 1156 | 1/5/20 |

Push button – 6 A - 250 V AC

| | | | |
|---------|--|-----|--------|
| 5734 13 | Bell push - 6 A - SP - 1 way - 1 module | 256 | 20/200 |
| 5734 59 | Bell push - 6 A - SP - 1 way - 2 module | 358 | 10/100 |
| 5734 04 | Push button - 6 A - SP - 1 way - 1 module | 270 | 20/200 |

* MRP - Maximum Retail Price Inclusive of all taxes including GST.
■ Price available on request

Arteor™ square - white mechanisms

| Cat.Nos | Description | MRP* ₹ / Unit | Pack |
|---------|-------------|------------------|------|
|---------|-------------|------------------|------|

Push button – 6 A - 250 V AC

| | | | |
|---------|--|-----|--------|
| 5734 05 | Push button - 6 A-SP - 1 way with indicator - 1 module | 342 | 20/200 |
| 5734 14 | Bell push - 6 A-SP - 1 way with indicator - 1 module | 340 | 20/200 |
| 5734 60 | Bell push - 6 A-SP - 1 way with indicator - 2 module | 482 | 10/100 |

Electric roller blinds control

| | | | |
|---------|--|-----|--------|
| 5722 20 | Double switch for electric shutter - 2 module | 626 | 10/100 |
|---------|--|-----|--------|

Dimmers and fan regulators

| | | | |
|---------|---|------|----------|
| 5734 62 | Light dimmer 60 to 400 watts - 2 module | 1002 | 10/100 |
| 5734 16 | Fan step regulator 100 watts - 1 module | 828 | 1/5/50 |
| 5734 63 | Fan step regulator 100 watts - 2 module | 1022 | 1/10/100 |
| 5734 69 | Fan step regulator 120 watts - 2 module (for 48 & 56" fans) | 1092 | 1/10/100 |
| 5734 68 | Fan step regulator - 2 module for energy saving fans | 1088 | 1/10/100 |

Electronic dimmers

| | | | |
|---------|---|------|------|
| 5734 65 | Universal touch dimmer 3 M | 6290 | 1/10 |
| 5722 39 | Universal dimmer without neutral 400 W - 2 module | ■ | 1/10 |

Indian standard sockets

| | | | |
|---------|--|------|--------|
| 5734 70 | Socket shuttered - 6 A - 2/3 pin - universal India 2 module | 314 | 20/200 |
| 5734 71 | Socket shuttered - 6/16 A - 3 pin - Indian - 2 module | 418 | 10/100 |
| 5734 67 | Socket shuttered - 6/16 A - 3 pin - Indian - 3 module | 504 | 5/50 |
| 5734 72 | Socket - 13 A - 3 pin - 2P+E BS - 2 module | 656 | 10/100 |
| 5735 10 | Socket with switch - 16 A - 3 pin - 2P+E - Indian - 3 module | 1184 | 5/50 |
| 5721 04 | Socket - 15/16 A - 2P - Euro/US - 1 module | 338 | 10/100 |
| 5737 79 | Socket - 6 A/13 A/15 A for 127 V, - double multistandard - 4 module | 728 | 5/50 |
| 5734 73 | Multistandard socket - 6/10/13 A - 2/3 pin for 250 V AC, 15 A for 127 V type - 2 pin - 2 module | 398 | 10/100 |
| 5734 66 | 25 A socket - 2 module | 510 | 10/100 |
| 5721 16 | Euro/US - 15 A-127 V/16 A - 250 V, 2P + E with shutter 2 module | 590 | 10/100 |

Bold Cat.Nos are products normally available with Legrand (India) Stockists.
Cat.Nos that are not bold - delivery within 4 - 8 weeks from the date of order.
Bold packing quantity is our mandatory packing. Orders to be placed by
Legrand (India) Stockist in multiples of the same.

Arteor™ square - white mechanisms

| Cat.Nos | Description | MRP* ₹ / Unit | Pack |
|---------|-------------|------------------|------|
|---------|-------------|------------------|------|

Energy plugs

| | | | |
|---------|-----------|-----|----------|
| 5738 86 | 6 A plug | 124 | 1/10/100 |
| 5738 88 | 16 A plug | 164 | 1/10/100 |
| 5738 07 | 25 A plug | 188 | 1/10/100 |

USB chargers (IS13252 (Part 1) / IEC 60950-1)

| | | | |
|-----------------|--------------------------------|------|----------|
| 5734 21 | USB Charger 1 M 1000 mA | 1508 | 1/5/50 |
| 5734 41* | USB Charger 1 M 1500 mA | 1734 | 1/5/50 |
| 5734 22 | Double USB Charger 2 M 2400 mA | 2404 | 1/10/100 |

RJ 11 telephone sockets (Jack type)

| | | | |
|---------|---|-----|--------|
| 5734 27 | Telephone socket - double RJ11 - 1 module | 370 | 20/200 |
| 5734 26 | Telephone socket - RJ11 with shutter - 1 module | 216 | 20/200 |

Information outlets - toolless

| | | | |
|---------|---|-----|--------|
| 5734 29 | Information socket - category 5e-UTP - 1 module | 512 | 20/200 |
| 5734 75 | Information socket - category 5e-UTP - 2 module | 550 | 10/100 |
| 5734 28 | Information socket - category 6-UTP - 1 module | 788 | 20/200 |
| 5734 74 | Information socket - category 6-UTP - 2 module | 828 | 10/100 |

TV sockets

| | | | |
|---------|-------------------------------|-----|--------|
| 5734 25 | TV Co-Axial socket - 1 module | 224 | 20/200 |
|---------|-------------------------------|-----|--------|

Electronic chime

| | | | |
|---------|--------------------------------|-----|----------|
| 5734 43 | Bell ding dong 230V - 2 module | 340 | 1/10/100 |
|---------|--------------------------------|-----|----------|

Buzzer

| | | | |
|---------|---------------------------|------|--------|
| 5734 42 | Buzzer - 230 V - 1 module | 1206 | 20/200 |
|---------|---------------------------|------|--------|

Bell call indicator & register - 6A - 250V AC

| | | | |
|---------|---|------|--------|
| 5734 15 | Bell call indicator with register - 6 A - 1 way - SP - 1 module | 1506 | 20/200 |
| 5736 06 | Set of labels for bell call indicator (1-20) | 408 | 5/50 |

Lighting

| | | | |
|---------|---|-------|--------|
| 5734 64 | Skirting light with LED - 230 V - 3 module | 812 | 1/5/25 |
| 5722 26 | Skirting light with detector (LED) - 230 V - 2 module | 14922 | 1/20 |
| 5722 34 | Miniature emergency skirting light unit - 2 module | 8178 | 1/20 |
| 5724 53 | Over door light unit (Red) 2 module | 454 | 10/100 |
| 5722 23 | Over door light unit (White) 2 module | 372 | 10/100 |
| 5724 52 | Indicator unit with transparent LED with coloured labels - 1 module | 606 | 10/100 |

* MRP - Maximum Retail Price Inclusive of all taxes including GST.
 * To be Introduced Shortly
 (1) Supplied with white plate
 ■ Price available on request

Arteor™ square - white mechanisms

| Cat.Nos | Description | MRP* ₹ / Unit | Pack |
|---------|-------------|------------------|------|
|---------|-------------|------------------|------|

Power strip and power units

| | | | |
|------------------------|---|------|------|
| 5737 80 | Set of 3 multistandard socket + Switch pre-wired - 8 module | 2124 | 1/10 |
| 5735 42 ⁽¹⁾ | 1 Power unit (AC & Geyser) 16 A - 4 module | 1334 | 1/5 |
| 5721 54 | Power unit (AC & Geyser) 32 A (with cable output) | 1500 | 1/5 |

MCB

| | | | |
|---------|---------------------------|------|---|
| 5723 61 | MCB - 16 A-SPN - 2 module | 3444 | 1 |
|---------|---------------------------|------|---|

RCBO

| | | | |
|---------|----------------------------|-------|---|
| 5734 85 | RCBO - 16 A-SPN - 2 module | 11748 | 1 |
|---------|----------------------------|-------|---|

Protectors

| | | | |
|---------|----------------------------|------|--------|
| 5734 40 | Surge protector - 1 module | 3588 | 20/200 |
| 5734 48 | Surge protector - 2 module | 4192 | 10/100 |

Hotel "DND and MMR" functions

| | | | |
|---------|---|------|--------|
| 5734 61 | DND and MMR indicator with bell push 1+1 module | 1618 | 5/50 |
| 5734 58 | Internal control unit for DND & MMR 1+1 module | 1162 | 10/100 |

Hotel keycard switch

| | | | |
|---------|-------------------------------------|------|-------|
| 5722 44 | 16 A key card switch 230 V 2 module | 4424 | 1/20 |
| 5722 59 | Key fob for above | 1206 | 10/50 |

Shaver socket

| | | | |
|---------|--|------|---|
| 5721 53 | Shaver socket 230 V / 120 - 230 V with earth connector | 4602 | 1 |
|---------|--|------|---|

Infrared sensors

| | | | |
|---------|---------------------------------------|------|------|
| 5740 47 | PIR sensor with neutral 2 module | 7746 | 1/20 |
| 5740 09 | PIR sensor without neutral - 2 module | 6366 | 1/20 |

Time switch

| | | | |
|---------|----------------------------|------|------|
| 5720 55 | Time delay switch 2 module | 5812 | 1/20 |
|---------|----------------------------|------|------|

Audio-video sockets

| | | | |
|---------|--|---|------|
| 5722 72 | Double RCA socket (audio) 1 module | ■ | 1/20 |
| 5722 73 | Triple RCA socket (audio & video) 1 module | ■ | 1/20 |
| 5722 74 | Female 3.5 mm Jack - 1 module | ■ | 1/20 |
| 5722 76 | Female BNC 75 jack - 1 module | ■ | 1/20 |
| 5722 83 | Female XLR jack - 2 module | ■ | 1/20 |
| 5723 70 | Kit HD 15 + jack amplified transceiver | ■ | 1 |
| 5720 97 | Preterminated sockets Female HD15 - 1 module | ■ | 1 |
| 5720 96 | Preterminated sockets HDMI 1.4 - 1 module | ■ | 1 |

Bold Cat.Nos are products normally available with Legrand (India) Stockists. Cat.Nos that are not bold - delivery within 4 - 8 weeks from the date of order. Bold packing quantity is our mandatory packing. Orders to be placed by Legrand (India) Stockist in multiples of the same.

Arteor™ square - white mechanisms

| Cat.Nos | Description | MRP* ₹ / Unit | Pack |
|---------|-------------|------------------|------|
|---------|-------------|------------------|------|

Audio-video sockets

| | | | |
|---------|--|---|------|
| 5722 84 | Line dying down 100 V (25-30W) 2 module | ■ | 1 |
| 5722 77 | Male XLR jack 2 module | ■ | 1/20 |
| 5722 78 | Female 3.5 mm Jack - solder - 1 module | ■ | 1/20 |
| 5722 75 | USB socket - 1 module | ■ | 1/20 |
| 5744 01 | S-VIDEO socket - 1 module | ■ | 1/40 |
| 5722 88 | Female HD15 + Jack 3.5 mm - 2 module | ■ | 1/20 |

Cable outlet

| | | | |
|---------|--|-----|--------|
| 5734 80 | 45 A cable outlet 2 module | 904 | 5/50 |
| 5734 33 | Cord outlet with 8 mm diameter - 1 module | 288 | 20/200 |
| 5734 79 | Standard cord outlet - 2 module | 412 | 10/100 |

Blanking plate

| | | | |
|---------|--------------------------------------|-----|--------|
| 5734 49 | 1 module blank | 46 | 20/200 |
| 5723 44 | 2 modules blank | 66 | 10/100 |
| 5758 10 | Blanking plate + frame - 2 module | 378 | 10/100 |

Mounting accessories for panel

| | | | |
|---------|--------------------------------------|-----|--------|
| 5760 15 | Panel mounting support - 1 module | 240 | 10/100 |
| 5760 16 | Panel mounting support - 2 module | 252 | 10/100 |
| 5760 50 | DIN rail support 2 module | 302 | 10/100 |

Square - magnesium mechanisms

Switches – 6 A - 250 V AC

| | | | |
|---------|--|-----|--------|
| 5736 00 | Switch - 6 A-SP - 1 way - 1 module | 196 | 20/200 |
| 5736 01 | Switch - 6 A-SP - 1 way with indicator - 1 module | 310 | 20/200 |
| 5736 02 | Switch - 6 A-SP - 2 way - 1 module | 278 | 20/200 |
| 5736 03 | Switch - 6 A-SP - 2 way with indicator - 1 module | 396 | 20/200 |

Switches – 10 A - 250 V AC

| | | | |
|---------|---|------|--------|
| 5736 50 | Switch - 10 A-SP - 1 way - 2 module | 296 | 10/100 |
| 5736 51 | Switch - 10 A-SP - 2 way - 2 module | 350 | 10/100 |
| 5725 37 | Switch - 10 A-SP - 2 way with indicator & label holder - 2 module | 1750 | 10/100 |
| 5725 38 | Intermediate switch - 2 module | 2142 | 10/100 |

Switches – 20 A - 250 V AC

| | | | |
|---------|--------------------------------------|-----|--------|
| 5736 10 | Switch - 20 A-SP - 1 way 1 module | 358 | 20/200 |
| 5736 52 | Switch - 20 A-SP - 1 way 2 module | 422 | 10/100 |

* MRP - Maximum Retail Price Inclusive of all taxes including GST.
■ Price available on request

Arteor™ square - magnesium mechanisms

| Cat.Nos | Description | MRP* ₹ / Unit | Pack |
|---------|-------------|------------------|------|
|---------|-------------|------------------|------|

Switches – 20 A - 250 V AC

| | | | |
|---------|---|------|--------|
| 5725 63 | Switch - 20 A-SP - 1 way with indicator - 1 module | 378 | 20/200 |
| 5736 11 | Switch - 20 A-SP - 2 way with indicator - 1 module | 518 | 20/200 |
| 5725 42 | Switch - 20 A-SP - 2 way with indicator - 2 module | 554 | 10/100 |
| 5725 43 | Switch - 20 A-3 gang - 1 way - 2 module | 1022 | 10/100 |
| 5725 44 | Switch - 20 A-3 gang - 2x2 way + 1x1 way - 2 module | 1068 | 10/100 |
| 5736 54 | Switch 20 A-DP - 1 way with indicator - 2 module | 828 | 10/100 |
| 5725 49 | Switch - 20 A-DP - 1 way with indicator and water heater marking - 2 module | 882 | 10/100 |

Switches – 25 A - 230 V AC

| | | | |
|---------|---------------------------|-----|--------|
| 5736 17 | 25A switch with indicator | 474 | 20/200 |
|---------|---------------------------|-----|--------|

Switches – 32 A / 40 A - 250 V AC

| | | | |
|---------|--|------|--------|
| 5736 12 | Switch - 32 A-DP - 1 way with indicator - 2 module | 1156 | 10/100 |
| 5737 30 | Switch - 40 A-DP - 1 way with indicator - fits on 1/2 module box | 1328 | 1/5/20 |

Push button – 6 A - 250 V AC

| | | | |
|---------|--|-----|--------|
| 5736 13 | Bell push - 6 A-SP - 1 way - 1 module | 288 | 20/200 |
| 5736 59 | Bell push - 6 A-SP - 1 way - 2 module | 412 | 10/100 |
| 5736 04 | Push button - 6 A-SP - 1 way - 1 module | 298 | 20/200 |
| 5736 05 | Push button - 6 A-SP - 1 way with indicator - 1 module | 398 | 20/200 |
| 5736 14 | Bell push - 6 A-SP - 1 way with indicator - 1 module | 396 | 20/200 |
| 5736 60 | Bell push - 6 A-SP - 1 way with indicator - 2 module | 550 | 10/100 |

Electric roller blinds control

| | | | |
|---------|--|-----|--------|
| 5727 20 | Double switch for electric shutter - 2 module | 724 | 10/100 |
|---------|--|-----|--------|

Dimmers and fan regulators

| | | | |
|---------|---|------|----------|
| 5736 62 | Light dimmer - 60 to 400 watts - 2 module | 1158 | 10/100 |
| 5736 16 | Fan step regulator - 100 watts - 1 module | 954 | 1/5/50 |
| 5736 63 | Fan step regulator - 100 watts - 2 module | 1176 | 1/10/100 |
| 5736 69 | Fan step regulator - 120 watts - 2 module (for 48 & 56" fans) | 1258 | 1/10/100 |
| 5736 68 | Fan step regulator - 2 module for energy saving fan | 1248 | 1/10/100 |

Electronic dimmer

| | | | |
|---------|--|---|------|
| 5727 39 | Universal dimmer without neutral 400 W - 2 module | ■ | 1/10 |
|---------|--|---|------|

Bold Cat.Nos are products normally available with Legrand (India) Stockists.
Cat.Nos that are not bold - delivery within 4 - 8 weeks from the date of order.
Bold packing quantity is our mandatory packing. Orders to be placed by
Legrand (India) Stockist in multiples of the same.

Arteor™ square - magnesium mechanisms



5736 70



5736 71



5739 79



5736 21

NEW!



5736 27



5736 28



5736 25

| Cat.Nos | Description | MRP* ₹ / Unit | Pack |
|---------|-------------|------------------|------|
|---------|-------------|------------------|------|

Indian standard sockets

| | | | |
|---------|--|------|--------|
| 5736 70 | Socket shuttered - 6 A - 2/3 pin - universal India - 2 module | 366 | 20/200 |
| 5736 71 | Socket shuttered - 6/16 A - 3 pin - Indian - 2 module | 482 | 10/100 |
| 5736 67 | Socket shuttered - 6/16 A - 3 pin - Indian - 3 module | 590 | 5/50 |
| 5736 72 | Socket - 13 A - 3 pin - 2P+E BS - 2 module | 758 | 10/100 |
| 5737 10 | Socket with switch - 16 A - 3 pin - 2P+E - Indian 3 module | 1362 | 5/50 |
| 5726 04 | Socket - 15/16 A - 2P - Euro/US - 1 module | 390 | 10/100 |
| 5739 79 | Socket w - 6 A/13 A/15 A for 127 V, - double multistandard - 4 module | 834 | 5/50 |
| 5736 73 | Multistandard socket - 6/10/13 A - 2/3 pin for 250 V AC 15 A for 127 V type - 2 pin 2 module | 446 | 10/100 |
| 5736 66 | 25 A socket - 2 module | 588 | 10/100 |
| 5726 16 | Euro/US 15 A-127 VA/16 A 230 V 2P+E with shutter 2 M | 698 | 10/100 |

USB chargers (IS13252 (Part 1) / IEC 60950-1)

| | | | |
|----------|------------------------------|------|----------|
| 5736 21 | USB Charger 1M 1000mA | 1740 | 1/5/50 |
| 5734 44* | USB Charger 1M 1500 mA | 2000 | 1/5/50 |
| 5736 22 | Double USB Charger 2M 2400mA | 2766 | 1/10/100 |

RJ 11 telephone sockets (Jack type)

| | | | |
|---------|---|-----|--------|
| 5736 27 | Telephone socket - double RJ11 - 1 module | 424 | 20/200 |
| 5736 26 | Telephone socket - RJ11 with shutter - 1 module | 258 | 20/200 |

Information outlets - toolless

| | | | |
|---------|---|-----|--------|
| 5736 29 | Information socket - category 5e - UTP - 1 module | 590 | 20/200 |
| 5736 75 | Information socket - category 5e - UTP - 2 module | 632 | 10/100 |
| 5736 28 | Information socket - category 6 - UTP - 1 module | 898 | 20/200 |
| 5736 74 | Information socket - category 6 - UTP - 2 module | 946 | 10/100 |

TV sockets

| | | | |
|---------|-------------------------------|-----|--------|
| 5736 25 | TV Co-Axial socket - 1 module | 264 | 20/200 |
|---------|-------------------------------|-----|--------|

Electronic chime

| | | | |
|---------|---------------------------------|-----|--------|
| 5736 43 | Bell ding dong 230 V - 2 module | 364 | 10/100 |
|---------|---------------------------------|-----|--------|

* MRP - Maximum Retail Price Inclusive of all taxes including GST.

* To be Introduced Shortly

(1) Supplied with white plate

■ Price available on request

Arteor™ square - magnesium mechanisms



5736 42



5735 64



5737 42



5736 61

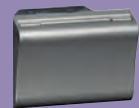

5727 44



5726 53



5740 97



5740 59



5740 84



5727 72

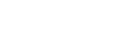

5727 73

| Cat.Nos | Description | MRP* ₹ / Unit | Pack |
|---------|-------------|------------------|------|
|---------|-------------|------------------|------|

Buzzer

| | | | |
|---------|--------------------------|------|--------|
| 5736 42 | Buzzer- 230 V - 1 module | 1320 | 20/200 |
|---------|--------------------------|------|--------|

Bell call indicator & register - 6A - 250V AC

| | | | |
|---------|---|------|--------|
| 5736 15 | Bell call indicator with register - 6 A - 1 way - SP - 1 module | 1740 | 20/200 |
|---------|---|------|--------|

Lighting

| | | | |
|---------|---|-------|--------|
| 5735 64 | Skirting light with LED - 230 V - 3 module | 934 | 1/5/25 |
| 5727 26 | Skirting light with detector (LED) - 230 V - 2 module | 17156 | 1/20 |

Power strip and power units (without plate)

| | | | |
|------------------------|---|------|------|
| 5739 80 | Set of 3 multistandard socket + switch pre-wired - 8 module | 2438 | 1/10 |
| 5737 42 ⁽³⁾ | Power unit (AC & Geyser) 16 A - 4 module | 1548 | 1/5 |
| 5726 54 | Power unit (AC & Geyser) 32 A (with cable output) 4 module | 1760 | 1/5 |

Hotel "DND and MMR " functions

| | | | |
|---------|---|------|--------|
| 5736 61 | DND and MMR indicator with bell push 1+1 module | 1858 | 5/50 |
| 5736 58 | Internal control unit for DND & MMR 1+1 module | 1344 | 10/100 |

Hotel keycard switch

| | | | |
|---------|---|------|-------|
| 5727 44 | 16 A Key card switch 230 V with time delay - 2 module | 4872 | 1/20 |
| 5727 59 | Key fob for above | 1676 | 10/50 |

Shaver socket

| | | | |
|---------|--|------|---|
| 5726 53 | Shaver socket 230 V / 120-230 V with earth connector | 5066 | 1 |
|---------|--|------|---|

Infrared sensors

| | | | |
|---------|---------------------------------------|------|------|
| 5740 97 | PIR sensor with neutral - 2 module | 8912 | 1/20 |
| 5740 59 | PIR sensor without neutral - 2 module | 7788 | 1/20 |

Time switch

| | | | |
|---------|------------------------------|------|------|
| 5740 84 | Time delay switch - 2 module | 6432 | 1/20 |
|---------|------------------------------|------|------|

Audio-video sockets

| | | | |
|---------|--|---|------|
| 5727 72 | Double RCA socket (audio) - 1 module | ■ | 1/20 |
| 5727 73 | Triple RCA socket (audio & video) - 1 module | ■ | 1/20 |
| 5727 74 | Female 3.5 mm Jack - 1 module | ■ | 1/20 |
| 5727 76 | Female BNC 75 jack - 1 module | ■ | 1/20 |

Bold Cat.Nos are products normally available with Legrand (India) Stockists. Cat.Nos that are not bold - delivery within 4 - 8 weeks from the date of order. Bold packing quantity is our mandatory packing. Orders to be placed by Legrand (India) Stockist in multiples of the same.

Arteor™ square - magnesium mechanisms

| Cat.Nos | Description | MRP* ₹ / Unit | Pack |
|---------|-------------|------------------|------|
|---------|-------------|------------------|------|

Audio-video sockets

| | | | |
|---------|---|---|------|
| 5727 83 | Female XLR jack - 2 module | ■ | 1/20 |
| 5728 70 | Kit HD 15 + Jack Amplified transceiver - 3*4 module | ■ | 1 |
| 5725 97 | Preterminated sockets Female HD15 - 1 module | ■ | 1 |

Audio-video sockets

| | | | |
|---------|---|---|------|
| 5725 96 | Preterminated sockets HDMI 1.4 - 1 module | ■ | 1 |
| 5727 84 | Line dying down 100 V (25-30 W) 2 module | ■ | 1 |
| 5727 77 | Male XLR jack 2 module | ■ | 1/20 |
| 5727 78 | Female 3.5 mm Jack - solder - 1 module | ■ | 1/20 |
| 5727 75 | USB socket - 1 module | ■ | 1/20 |
| 5744 51 | S-VIDEO socket - 1 module | ■ | 1/40 |
| 5727 88 | Female HD15 + Jack 3.5 mm - 2 module | ■ | 1/20 |

Blanking plate

| | | | |
|---------|-----------------|----|--------|
| 5736 49 | 1 module blank | 46 | 20/200 |
| 5728 44 | 2 modules blank | 72 | 10/100 |

Dedicated switches

| | | | |
|---------|---|-----|--------|
| 5738 00 | Dedicated switch - 6 A - 1 way - SP - red - 1 module | 230 | 20/200 |
| 5738 01 | Dedicated switch - 10 A - 1 way - SP - red - 1 module | 232 | 20/200 |
| 5738 02 | Dedicated switch - 20 A - 1 way - DP - red - 1 module | 800 | 5/40 |

Tamper proof and dedicated sockets

| | | | |
|---------|--|------|----------|
| 5738 08 | Tamperproof red Indian socket 6 A (2/3 pin) - 2 module | 638 | 20/200 |
| 5738 10 | Dedicated socket with switch - 16 A - 3 pin - 2P+E - Indian - 3 module | 1672 | 5/50 |
| 5738 09 | Insert for tamper proof Indian socket - 6 A | 84 | 1/20/200 |

Square - Champagne mechanisms

Switches – 6 A - 250 V AC

| | | | |
|---------|---|-----|--------|
| 5748 00 | Switch - 6 A-SP - 1 way - 1 module | 196 | 20/200 |
| 5748 01 | Switch - 6 A-SP - 1 way with indicator - 1 module | 310 | 20/200 |
| 5748 02 | Switch - 6 A-SP - 2 way - 1 module | 278 | 20/200 |
| 5748 03 | Switch - 6 A-SP - 2 way with indicator - 1 module | 396 | 20/200 |

Arteor™ square - champagne mechanisms

| Cat.Nos | Description | MRP* ₹ / Unit | Pack |
|---------|-------------|------------------|------|
|---------|-------------|------------------|------|

Switches – 10 A - 250 V AC

| | | | |
|---------|---|------|--------|
| 5748 04 | Switch - 10 A-SP - 1 way - 2 module | 296 | 10/100 |
| 5748 05 | Switch - 10 A-SP - 2 way - 2 module | 350 | 10/100 |
| 5748 06 | Switch - 10 A-SP - 2 way with indicator & label holder - 2 module | 1750 | 10/100 |
| 5748 07 | Intermediate switch - 2 module | 2142 | 10/100 |

Switches – 20 A - 250 V AC

| | | | |
|---------|---|------|--------|
| 5748 08 | Switch - 20 A-SP - 1 way 1 module | 358 | 20/200 |
| 5748 09 | Switch - 20 A-SP - 1 way 2 module | 422 | 10/100 |
| 5748 10 | Switch - 20 A-SP - 1 way with indicator - 1 module | 378 | 20/200 |
| 5748 11 | Switch - 20 A-SP - 2 way with indicator - 1 module | 518 | 20/200 |
| 5748 12 | Switch - 20 A-SP - 2 way with indicator - 2 module | 554 | 10/100 |
| 5748 13 | Switch - 20 A-3 gang - 1 way - 2 module | 1022 | 10/100 |
| 5748 14 | Switch - 20 A-3 gang - 2x2 way + 1x1 way - 2 module | 1068 | 10/100 |
| 5748 15 | Switch 20 A-DP - 1 way with indicator - 2 module | 828 | 10/100 |
| 5748 16 | Switch - 20 A-DP - 1 way with indicator and water heater marking - 2 module | 882 | 10/100 |

Switches – 25 A - 230 V AC

| | | | |
|---------|---------------------------|-----|--------|
| 5748 17 | 25A switch with indicator | 474 | 20/200 |
|---------|---------------------------|-----|--------|

Switches – 32 A / 40 A - 250 V AC

| | | | |
|---------|--|------|--------|
| 5748 18 | Switch - 32 A-DP - 1 way with indicator - 2 module | 1156 | 10/100 |
| 5748 19 | Switch - 40 A-DP - 1 way with indicator - fits on 1/2 module box | 1328 | 1/5/20 |

Push button – 6 A - 250 V AC

| | | | |
|---------|--|-----|--------|
| 5748 23 | Bell push - 6 A-SP - 1 way - 1 module | 288 | 20/200 |
| 5748 24 | Bell push - 6 A-SP - 1 way - 2 module | 412 | 10/100 |
| 5748 21 | Push button - 6 A-SP - 1 way - 1 module | 298 | 20/200 |
| 5748 22 | Push button - 6 A-SP - 1 way with indicator - 1 module | 398 | 20/200 |
| 5748 25 | Bell push - 6 A-SP - 1 way with indicator - 1 module | 396 | 20/200 |
| 5748 26 | Bell push - 6 A-SP - 1 way with indicator - 2 module | 550 | 10/100 |

Electric roller blinds control

| | | | |
|---------|---|-----|--------|
| 5748 20 | Double switch for electric shutter - 2 module | 724 | 10/100 |
|---------|---|-----|--------|

* MRP - Maximum Retail Price Inclusive of all taxes including GST.
Red Cat.Nos - new products
■ Price available on request.

Bold Cat.Nos are products normally available with Legrand (India) Stockists. Cat.Nos that are not bold - delivery within 4 - 8 weeks from the date of order. Bold packing quantity is our mandatory packing. Orders to be placed by Legrand (India) Stockist in multiples of the same.



5736 49



5738 01



5738 08



5748 00



5748 01



5748 05



5748 07



5748 11



5748 15



5748 16



5748 17



5748 18



5748 23



5748 26



5748 20

Arteor™ square - champagne mechanisms

Arteor™ square - champagne mechanisms

| Cat.Nos | Description | MRP* ₹ / Unit | Pack |
|--|--|------------------|----------|
| Dimmers and fan regulators | | | |
| 5748 27 | Light dimmer - 60 to 400 watts - 2 module | 1194 | 10/100 |
| 5748 29 | Fan step regulator - 100 watts - 1 module | 954 | 1/5/50 |
| 5748 30 | Fan step regulator - 100 watts - 2 module | 1176 | 1/10/100 |
| 5748 31 | Fan step regulator - 120 watts - 2 module (for 48 & 56" fans) | 1258 | 1/10/100 |
| 5748 32 | Fan step regulator - 2 module for energy saving fan | 1248 | 1/10/100 |
| Indian standard sockets | | | |
| 5748 33 | Socket shuttered - 6 A - 2/3 pin - universal India - 2 module | 364 | 20/200 |
| 5748 34 | Socket shuttered - 6/16 A - 3 pin - Indian - 2 module | 482 | 10/100 |
| 5748 35 | Socket shuttered - 6/16 A - 3 pin - Indian - 3 module | 590 | 5/50 |
| 5748 39 | Socket w - 6 A/13 A/15 A for 127 V, - double multistandard - 4 module | 834 | 5/50 |
| 5748 40 | Multistandard socket - 6/10/13 A - 2/3 pin for 250 V AC 15 A for 127 V type - 2 pin 2 module | 446 | 10/100 |
| 5748 41 | 25 A socket - 2 module | 588 | 10/100 |
| USB chargers (IS13252 (Part 1) / IEC 60950-1) | | | |
| 5748 43 | USB Charger 1M 1000mA | 1740 | 1/5/50 |
| 5734 47* | USB Charger 1M 1500 mA | 2000 | 1/5/50 |
| 5748 44 | Double USB Charger 2M 2400mA | 2766 | 1/10/100 |
| RJ 11 telephone sockets (Jack type) | | | |
| 5748 45 | Telephone socket - double RJ11 - 1 module | 424 | 20/200 |
| 5748 46 | Telephone socket - RJ11 with shutter - 1 module | 258 | 20/200 |
| Information outlets - toolless | | | |
| 5748 47 | Information socket - category 5e - UTP - 1 module | 590 | 20/200 |
| 5748 48 | Information socket - category 5e - UTP - 2 module | 632 | 10/100 |
| 5748 49 | Information socket - category 6 - UTP - 1 module | 898 | 20/200 |
| 5748 50 | Information socket - category 6 - UTP - 2 module | 946 | 10/100 |
| TV sockets | | | |
| 5748 51 | TV Co-Axial socket - 1 module | 264 | 20/200 |

| Cat.Nos | Description | MRP* ₹ / Unit | Pack |
|--|---|------------------|--------|
| Electronic chime | | | |
| 5748 52 | Bell ding dong 230 V - 2 module | 364 | 10/100 |
| Buzzer | | | |
| 5748 53 | Buzzer- 230 V - 1 module | 1320 | 20/200 |
| Bell call indicator & register - 6A - 250V AC | | | |
| 5748 54 | Bell call indicator with register - 6 A - 1 way - SP - 1 module | 1740 | 20/200 |
| Lighting | | | |
| 5748 55 | Skirting light with LED - 230 V - 3 module | 934 | 1/5/25 |
| Hotel "DND and MMR" functions | | | |
| 5748 56 | DND and MMR indicator with bell push 1+1 module | 1858 | 5/50 |
| 5748 57 | Internal control unit for DND & MMR 1+1 module | 1344 | 10/100 |
| Hotel keycard switch | | | |
| 5748 58 | 16 A Key card switch 230 V with time delay - 2 module | 4872 | 1/20 |
| 5727 59 | Key fob for above | 1676 | 10/50 |
| Blanking plate | | | |
| 5748 63 | 1 module blank | 46 | 20/200 |
| 5748 64 | 2 modules blank | 72 | 10/100 |
| Round - white mechanisms | | | |
| Switches - 6 A - 250 V AC | | | |
| 5733 00 | Switch - 6 A-SP - 1 way left - 1 module | 232 | 20/200 |
| 5733 01 | Switch - 6 A-SP - 1 way right - 1 module | 232 | 20/200 |
| 5733 12 | Switch - 6 A-SP - 1 way - middle - 1 module | 232 | 20/200 |
| 5733 05 | Switch - 6 A-SP - 2 way - left - 1 module | 286 | 20/200 |
| 5733 06 | Switch - 6 A-SP - 2 way - right - 1 module | 286 | 20/200 |
| 5733 02 | Switch - 6 A-SP - 1 way with indicator - left - 1 module | 326 | 20/200 |
| 5733 04 | Switch - 6 A-SP - 1 way with indicator - right - 1 module | 326 | 20/200 |
| 5733 03 | Switch - 6 A-SP - 1 way with indicator - middle - 1 module | 326 | 20/200 |
| 5733 07 | Switch - 6 A-SP - 2 way with indicator - left - 1 module | 410 | 20/200 |
| 5733 08 | Switch - 6 A-SP - 2 way with indicator - right - 1 module | 410 | 20/200 |

* MRP - Maximum Retail Price Inclusive of all taxes including GST.
 * To be Introduced Shortly
 Red Cat.Nos - new products
 (1) Supplied with white plate
 ■ Price available on request

Bold Cat.Nos are products normally available with Legrand (India) Stockists.
 Cat.Nos that are not bold - delivery within 4 - 8 weeks from the date of order.
 Bold packing quantity is our mandatory packing. Orders to be placed by Legrand (India) Stockist in multiples of the same.

Arteor™ round - white mechanisms

| Cat.Nos | Description | MRP* ₹ / Unit | Pack |
|---------|-------------|------------------|------|
|---------|-------------|------------------|------|

Switches – 20 A - 250 V AC

| | | | |
|---------|---|------|--------|
| 5733 20 | Switch - 20 A-SP - 1 way - left - 1 module | 382 | 20/200 |
| 5733 21 | Switch - 20 A-SP - 1 way - right - 1 module | 382 | 20/200 |
| 5730 21 | Switch - 20 A-SP - 1 way - middle - 1 module | 386 | 20/200 |
| 5733 40 | Switch - 20 A-SP - 1 way - 2 module | 444 | 10/100 |
| 5720 64 | Switch - 20 A-SP - 1 way with indicator-left - 1 module | 394 | 20/200 |
| 5720 65 | Switch - 20 A-SP - 1 way with indicator-right - 1 module | 394 | 20/200 |
| 5730 24 | Switch - 20 A-SP - 2 way - middle - 1 module | 394 | 20/200 |
| 5733 22 | Switch - 20 A-SP - 2 way with indicator-left - 1 module | 548 | 20/200 |
| 5733 23 | Switch - 20 A-SP - 2 way with indicator-right - 1 module | 548 | 20/200 |
| 5730 71 | Switch - 20 A-SP - 2 way with indicator - 2 module | 484 | 10/100 |
| 5730 72 | Switch - 20 A-3 gang - 1 way - 2 module | 1066 | 10/100 |
| 5730 73 | Switch - 20 A-3 gang - 2x2 way+1x1 way - 2 module | 1174 | 10/100 |
| 5733 42 | Switch 20 A-DP - 1 way with indicator - 2 module | 828 | 10/100 |
| 5730 27 | Switch - 20 A-SP - 2 way with indicator - middle - 1 module | 548 | 20/200 |

Switches - 32 A

| | | | |
|---------|--|------|--------|
| 5733 26 | Switch - 32 A-DP - 1 way with indicator - 2 module | 1204 | 10/100 |
|---------|--|------|--------|

Push button – 6 A - 250 V AC

| | | | |
|---------|--|-----|--------|
| 5733 31 | Bell push - 6 A-SP - 1 way - right - 1 module | 298 | 20/200 |
| 5733 30 | Bell push - 6 A-SP - 1 way - left - 1 module | 298 | 20/200 |
| 5733 46 | Bell push - 6 A-SP - 1 way - 2 module | 424 | 10/100 |
| 5733 09 | Push button - 6 A-SP - 1 way - left - 1 module | 316 | 20/200 |
| 5733 11 | Push button - 6 A-SP - 1 way - right - 1 module | 316 | 20/200 |
| 5733 47 | Bell push - 6 A-SP - 1 way with indicator - 2 module | 576 | 10/100 |
| 5733 10 | Push button - 6 A-SP - 1 way - middle - 1 module | 316 | 20/200 |

Electric roller blinds control

| | | | |
|---------|------------------------------------|-----|--------|
| 5732 20 | Double pole switch 10 A - 2 module | 754 | 10/100 |
|---------|------------------------------------|-----|--------|

Dimmers and fan regulators

| | | | |
|---------|--|------|----------|
| 5730 66 | Light dimmer - 60 to 400 Watts - 2 module | 1210 | 1/10/100 |
| 5730 03 | Fan step regulator - 100 Watts - 2 module | 1228 | 1/10/100 |
| 5730 69 | Fan step regulator - 120 Watts - 2 module | 1330 | 1/10/100 |
| 5730 04 | Fan step regulator - 2 module for energy saving fans | 1300 | 1/10/100 |

* MRP - Maximum Retail Price Inclusive of all taxes including GST.
■ Price available on request.

Arteor™ round - white mechanisms

| Cat.Nos | Description | MRP* ₹ / Unit | Pack |
|---------|-------------|------------------|------|
|---------|-------------|------------------|------|

Electronic dimmer

| | | | |
|---------|---|---|------|
| 5743 19 | Universal dimmer without neutral 400 W - 2 module | ■ | 1/10 |
|---------|---|---|------|

Multistandard sockets

| | | | |
|---------|--|-----|--------|
| 5734 89 | Multistandard socket 6/10/13 A - 2/3 pin for 250 V AC 15 A for 127 V type - 2 pin 2 module | 452 | 10/100 |
|---------|--|-----|--------|

USB chargers (IS13252 (Part 1) / IEC 60950-1)

| | | | |
|---------|------------------------------|------|----------|
| 5734 23 | Double USB Charger 2M 2400mA | 2660 | 1/10/100 |
|---------|------------------------------|------|----------|

Information outlets - toolless

| | | | |
|---------|--|------|--------|
| 5723 24 | Information socket - category 6-UTP - 2 module | 1054 | 10/100 |
|---------|--|------|--------|

Hotel internal control units

| | | | |
|---------|--|------|------|
| 5720 74 | Internal control unit for DND & MMR - 1+1 module | 1626 | 5/50 |
| 5720 67 | DND & MMR indicator with bell push - 2 module | 2042 | 5/40 |

Audio-video sockets

| | | | |
|---------|--|---|------|
| 5732 72 | Double RCA socket (audio) - 2 module | ■ | 1/20 |
| 5732 73 | Triple RCA socket (audio & video) - 2 module | ■ | 1/20 |
| 5722 85 | HDMI socket - 2 module | ■ | 1/20 |
| 5745 01 | S-VIDEO socket - 2 module | ■ | 1/20 |
| 5722 89 | Female HD15 + Jack 3.5 mm - 2 module | ■ | 1/20 |

Blanking plate

| | | | |
|---------|-----------------|----|--------|
| 5730 87 | 2 modules blank | 74 | 10/100 |
|---------|-----------------|----|--------|

Round - magnesium mechanisms

Switches - 6 A - 250 V AC

| | | | |
|---------|--|-----|--------|
| 5733 50 | Switch - 6 A-SP - 1 way - left - 1 module | 270 | 20/200 |
| 5733 51 | Switch - 6 A-SP - 1 way - right - 1 module | 270 | 20/200 |
| 5733 62 | Switch - 6 A-SP - 1 way - middle - 1 module | 270 | 20/200 |
| 5733 55 | Switch - 6 A-SP - 2 way - left - 1 module | 330 | 20/200 |
| 5733 56 | Switch - 6 A-SP - 2 way - right - 1 module | 330 | 20/200 |
| 5733 52 | Switch - 6 A-SP - 1 way with indicator - left - 1 module | 368 | 20/200 |

Switches - 6 A - 250 V AC

| | | | |
|---------|--|-----|--------|
| 5733 54 | Switch - 6 A-SP - 1 way with indicator - right - 1 module | 368 | 20/200 |
| 5733 53 | Switch - 6 A-SP - 1 way with indicator - middle - 1 module | 368 | 20/200 |
| 5733 57 | Switch - 6 A-SP - 2 way with indicator - left - 1 module | 474 | 20/200 |
| 5733 58 | Switch - 6 A-SP - 2 way with indicator - right - 1 module | 474 | 20/200 |

Bold Cat.Nos are products normally available with Legrand (India) Stockists. Cat.Nos that are not bold - delivery within 4 - 8 weeks from the date of order. Bold packing quantity is our mandatory packing. Orders to be placed by Legrand (India) Stockist in multiples of the same.

Arteor™ round - magnesium mechanisms

| Cat.Nos | Description | MRP* ₹ / Unit | Pack |
|---------|-------------|------------------|------|
|---------|-------------|------------------|------|

Switches - 20 A - 250 V AC

| | | | |
|---------|---|------|--------|
| 5733 70 | Switch - 20 A-SP - 1 way - left - 1 module | 426 | 20/200 |
| 5733 71 | Switch - 20 A-SP - 1 way - right - 1 module | 426 | 20/200 |
| 5731 21 | Switch - 20 A-SP- 1 way - middle - 1 module | 426 | 20/200 |
| 5733 90 | Switch - 20 A-SP - 1 way - 2 module | 506 | 10/100 |
| 5725 64 | Switch - 20 A-SP - 1 way with indicator - left - 1 module | 444 | 20/200 |
| 5725 65 | Switch - 20 A-SP - 1 way with indicator - right - 1 module | 444 | 20/200 |
| 5731 24 | Switch - 20 A-SP - 2 way - middle - 1 module | 450 | 20/200 |
| 5733 72 | Switch - 20 A-SP - 2 way with indicator - left - 1 module | 620 | 20/200 |
| 5733 73 | Switch - 20 A-SP - 2 way with indicator - right - 1 module | 620 | 20/200 |
| 5731 71 | Switch - 20 A-SP - 2 way with indicator - 2 module | 590 | 10/100 |
| 5731 72 | Switch - 20 A-3 gang - 1 way - 2 module | 1224 | 10/100 |
| 5731 73 | Switch - 20 A-3 gang - 2x2 way + 1x1 way - 2 module | 1292 | 10/100 |
| 5733 92 | Switch 20 A-DP - 1 way with indicator - 2 module | 956 | 10/100 |
| 5731 27 | Switch - 20 A-SP - 2 way with indicator - middle - 1 module | 620 | 20/200 |

Switches - 32A

| | | | |
|---------|--|------|--------|
| 5733 76 | Switch - 32 A-DP - 1 way with indicator - 2 module | 1378 | 10/100 |
|---------|--|------|--------|

Push button - 6 A - 250 V AC

| | | | |
|---------|--|-----|--------|
| 5733 81 | Bell push - 6 A-SP - 1 way - right - 1 module | 350 | 20/200 |
| 5733 80 | Bell push - 6 A-SP - 1 way - left - 1 module | 350 | 20/200 |
| 5733 96 | Bell push - 6 A-SP - 1 way - 2 module | 496 | 10/100 |
| 5733 59 | Push button - 6 A-SP - 1 way - left - 1 module | 368 | 20/200 |
| 5733 61 | Push button - 6 A-SP - 1 way - right - 1 module | 368 | 20/200 |
| 5733 97 | Bell push - 6 A-SP - 1 way with indicator - 2 module | 652 | 10/100 |
| 5733 60 | Push button - 6 A-SP - 1 way - middle - 1 module | 368 | 20/200 |

Electronic roller blinds control

| | | | |
|---------|------------------------------------|-----|--------|
| 5737 20 | Double pole switch 10 A - 2 module | 874 | 10/100 |
|---------|------------------------------------|-----|--------|

Dimmers and fan regulators

| | | | |
|---------|--|------|----------|
| 5733 66 | Light dimmer - 60 to 400 watts - 2 module | 1404 | 1/10/100 |
| 5731 03 | Fan step regulator - 100 watts - 2 module | 1408 | 1/10/100 |
| 5731 69 | Fan step regulator - 120 watts - 2 module | 1520 | 1/10/100 |
| 5731 04 | Fan step regulator - 2 module for energy saving fans | 1500 | 1/10/100 |

* MRP - Maximum Retail Price Inclusive of all taxes including GST.
Red Cat.Nos - new products
■ Price available on request.

Arteor™ round - magnesium mechanisms

| Cat.Nos | Description | MRP* ₹ / Unit | Pack |
|---------|-------------|------------------|------|
|---------|-------------|------------------|------|

Electronic dimmer

| | | | |
|---------|---|---|------|
| 5743 39 | Universal dimmer without neutral 400 W - 2 module | ■ | 1/10 |
|---------|---|---|------|

Multistandard sockets

| | | | |
|---------|--|-----|--------|
| 5736 89 | Multistandard socket 6/10/13 A - 2/3 pin for 250 V AC 15 A for 127 V type - 2 pin 2 module | 522 | 10/100 |
|---------|--|-----|--------|

USB chargers (IS13252 (Part 1) / IEC 60950-1)

| | | | |
|---------|------------------------------|------|----------|
| 5736 23 | Double USB Charger 2M 2400mA | 3046 | 1/10/100 |
|---------|------------------------------|------|----------|

Information outlets - toolless

| | | | |
|---------|--|------|--------|
| 5728 24 | Information socket - category 6 - UTP - 2 module | 1206 | 10/100 |
|---------|--|------|--------|

Hotel internal control units

| | | | |
|---------|--|------|------|
| 5725 74 | Internal control unit for DND & MMR - 1+1 module | 1866 | 5/50 |
| 5725 67 | DND & MMR Indicator with bell push - 2 module | 2230 | 5/40 |

Audio-video sockets

| | | | |
|---------|--|---|------|
| 5737 72 | Double RCA socket (audio) - 2 module | ■ | 1/20 |
| 5737 73 | Triple RCA socket (audio & video) - 2 module | ■ | 1/20 |
| 5727 85 | HDMI socket - 2 module | ■ | 1/20 |
| 5745 51 | S-VIDEO socket - 2 module | ■ | 1/20 |
| 5727 89 | Female HD15 + jack 3.5 mm - 2 module | ■ | 1/20 |

Blanking plate

| | | | |
|---------|-----------------|----|--------|
| 5731 87 | 2 modules blank | 86 | 10/100 |
|---------|-----------------|----|--------|

Round - champagne mechanisms

Switches - 6 A - 250 V AC

| | | | |
|---------|--|-----|--------|
| 5749 00 | Switch - 6 A-SP - 1 way - left - 1 module | 270 | 20/200 |
| 5749 01 | Switch - 6 A-SP - 1 way - right - 1 module | 270 | 20/200 |
| 5749 02 | Switch - 6 A-SP - 1 way - middle - 1 module | 270 | 20/200 |
| 5749 03 | Switch - 6 A-SP - 2 way - left - 1 module | 330 | 20/200 |
| 5749 04 | Switch - 6 A-SP - 2 way - right - 1 module | 330 | 20/200 |
| 5749 05 | Switch - 6 A-SP - 1 way with indicator - left - 1 module | 368 | 20/200 |
| 5749 06 | Switch - 6 A-SP - 1 way with indicator - right - 1 module | 368 | 20/200 |
| 5749 07 | Switch - 6 A-SP - 1 way with indicator - middle - 1 module | 368 | 20/200 |
| 5749 08 | Switch - 6 A-SP - 2 way with indicator - left - 1 module | 474 | 20/200 |
| 5749 09 | Switch - 6 A-SP - 2 way with indicator - right - 1 module | 474 | 20/200 |

Bold Cat.Nos are products normally available with Legrand (India) Stockists. Cat.Nos that are not bold - delivery within 4 - 8 weeks from the date of order. Bold packing quantity is our mandatory packing. Orders to be placed by Legrand (India) Stockist in multiples of the same.

Arteor™ round - champagne mechanisms

| Cat.Nos | Description | MRP* ₹ / Unit | Pack |
|---------|-------------|------------------|------|
|---------|-------------|------------------|------|

Switches - 20 A - 250 V AC

| | | | |
|---------|--|------|--------|
| 5749 10 | Switch - 20 A-SP - 1 way - left - 1 module | 426 | 20/200 |
| 5749 11 | Switch - 20 A-SP - 1 way - right - 1 module | 426 | 20/200 |
| 5749 12 | Switch - 20 A-SP - 1 way - middle - 1 module | 426 | 20/200 |
| 5749 13 | Switch - 20 A-SP - 1 way - 2 module | 506 | 10/100 |
| 5749 14 | Switch - 20 A-SP - 1 way with indicator - left - 1 module | 444 | 20/200 |
| 5749 15 | Switch - 20 A-SP - 1 way with indicator - right - 1 module | 444 | 20/200 |
| 5749 16 | Switch - 20 A-SP - 2 way - middle - 1 module | 450 | 20/200 |
| 5749 17 | Switch - 20 A-SP - 2 way with indicator - left - 1 module | 620 | 20/200 |
| 5749 18 | Switch - 20 A-SP - 2 way with indicator - right - 1 module | 620 | 20/200 |
| 5749 19 | Switch - 20 A-SP - 2 way with indicator - 2 module | 590 | 10/100 |
| 5749 20 | Switch - 20 A-3 gang - 1 way - 2 module | 1224 | 10/100 |
| 5749 21 | Switch - 20 A-3 gang - 2x2 way + 1x1 way - 2 module | 1292 | 10/100 |
| 5749 22 | Switch 20 A-DP - 1 way with indicator - 2 module | 956 | 10/100 |

Push button - 6 A - 250 V AC

| | | | |
|---------|--|-----|--------|
| 5749 23 | Bell push - 6 A-SP - 1 way - right - 1 module | 350 | 20/200 |
| 5749 24 | Bell push - 6 A-SP - 1 way - left - 1 module | 350 | 20/200 |
| 5749 25 | Bell push - 6 A-SP - 1 way - 2 module | 496 | 10/100 |
| 5749 26 | Bell push - 6 A-SP - 1 way with indicator - 2 module | 652 | 10/100 |

Dimmers and fan regulators

| | | | |
|---------|--|------|----------|
| 5749 27 | Light dimmer - 60 to 400 watts - 2 module | 1446 | 1/10/100 |
| 5749 29 | Fan step regulator - 100 watts - 2 module | 1408 | 1/10/100 |
| 5749 30 | Fan step regulator - 120 watts - 2 module | 1520 | 1/10/100 |
| 5749 31 | Fan step regulator - 2 module for energy saving fans | 1500 | 1/10/100 |

Multistandard sockets

| | | | |
|---------|--|-----|--------|
| 5749 40 | Multistandard socket 6/10/13 A - 2/3 pin for 250 V AC 15 A for 127 V type - 2 pin 2 module | 522 | 10/100 |
|---------|--|-----|--------|

USB chargers (IS13252 (Part 1) / IEC 60950-1)

| | | | |
|---------|------------------------------|------|----------|
| 5749 44 | Double USB Charger 2M 2400mA | 3046 | 1/10/100 |
|---------|------------------------------|------|----------|

Blanking plate

| | | | |
|---------|-----------------|----|--------|
| 5749 64 | 2 modules blank | 86 | 10/100 |
|---------|-----------------|----|--------|

* MRP - Maximum Retail Price Inclusive of all taxes including GST.
Red Cat.Nos - new products

Arteor™ square cover plates

| Cat.Nos | Description | MRP* ₹ / Unit | Pack |
|---------|-------------|------------------|------|
|---------|-------------|------------------|------|

Square cover plates with Metal Frame White cover plates with Metal frame

| | | | |
|---------|--|------|--------|
| 5757 00 | White plate - 1 module | 166 | 10/100 |
| 5757 10 | White plate - 2 module | 176 | 10/100 |
| 5757 20 | White plate - 3 module | 194 | 10/100 |
| 5757 30 | White plate - 4 module | 208 | 5/50 |
| 5757 40 | White plate - 6 module | 376 | 5/30 |
| 5757 50 | White plate - 8 module | 420 | 5/30 |
| 5757 60 | White plate - 2x4 module | 526 | 2/20 |
| 5757 70 | White plate - 2x6 module | 644 | 2/16 |
| 5757 80 | White plate - 2x8 module | 772 | 2/16 |
| 5757 90 | White plate - 3x6 module | 854 | 2/12 |
| 5758 00 | White plate - 3x8 module | 1020 | 2/12 |
| 5750 70 | White plate for shaver socket 3 module | 294 | 5/50 |

Pearl Aluminium cover plates with Metal frame

| | | | |
|---------|------------------------------------|------|--------|
| 5759 73 | Pearl Aluminium plate - 1 module | 246 | 10/100 |
| 5759 74 | Pearl Aluminium plate - 2 module | 258 | 10/100 |
| 5759 75 | Pearl Aluminium plate - 3 module | 278 | 10/100 |
| 5759 76 | Pearl Aluminium plate - 4 module | 314 | 5/50 |
| 5759 77 | Pearl Aluminium plate - 6 module | 536 | 5/30 |
| 5759 78 | Pearl Aluminium plate - 8 module | 592 | 5/30 |
| 5759 79 | Pearl Aluminium plate - 2x4 module | 750 | 2/20 |
| 5759 80 | Pearl Aluminium plate - 2x6 module | 978 | 2/16 |
| 5759 81 | Pearl Aluminium plate - 2x8 module | 1108 | 2/16 |
| 5759 82 | Pearl Aluminium plate - 3x6 module | 1290 | 2/12 |
| 5759 83 | Pearl Aluminium plate - 3x8 module | 1472 | 2/12 |

Graphite cover plates with Metal frame

| | | | |
|---------|-----------------------------|------|--------|
| 5759 61 | Graphite plate - 1 module | 246 | 10/100 |
| 5759 62 | Graphite plate - 2 module | 258 | 10/100 |
| 5759 63 | Graphite plate - 3 module | 278 | 10/100 |
| 5759 64 | Graphite plate - 4 module | 314 | 5/50 |
| 5759 66 | Graphite plate - 6 module | 536 | 5/30 |
| 5759 67 | Graphite plate - 8 module | 592 | 5/30 |
| 5759 68 | Graphite plate - 2x4 module | 750 | 2/20 |
| 5759 69 | Graphite plate - 2x6 module | 978 | 2/16 |
| 5759 70 | Graphite plate - 2x8 module | 1108 | 2/16 |
| 5759 71 | Graphite plate - 3x6 module | 1290 | 2/12 |
| 5759 72 | Graphite plate - 3x8 module | 1472 | 2/12 |

Magnesium cover plates with Metal frame

| | | | |
|---------|------------------------------|------|--------|
| 5755 89 | Magnesium plate - 1 module | 246 | 10/100 |
| 5755 90 | Magnesium plate - 2 module | 258 | 10/100 |
| 5755 91 | Magnesium plate - 3 module | 278 | 10/100 |
| 5755 93 | Magnesium plate - 4 module | 312 | 5/50 |
| 5755 94 | Magnesium plate - 6 module | 534 | 5/30 |
| 5755 95 | Magnesium plate - 8 module | 592 | 5/30 |
| 5755 96 | Magnesium plate - 2x4 module | 750 | 2/20 |
| 5755 97 | Magnesium plate - 2x6 module | 978 | 2/16 |
| 5755 98 | Magnesium plate - 2x8 module | 1108 | 2/16 |
| 5755 99 | Magnesium plate - 3x6 module | 1290 | 2/12 |

Champagne cover plates with Metal frame

| | | | |
|---------|----------------------------|-----|--------|
| 5759 84 | Champagne plate - 1 module | 246 | 10/100 |
| 5759 85 | Champagne plate - 2 module | 258 | 10/100 |
| 5759 86 | Champagne plate - 3 module | 278 | 10/100 |
| 5759 87 | Champagne plate - 4 module | 312 | 5/50 |

Bold Cat.Nos are products normally available with Legrand (India) Stockists.
Cat.Nos that are not bold - delivery within 4 - 8 weeks from the date of order.
Bold packing quantity is our mandatory packing. Orders to be placed by Legrand (India) Stockist in multiples of the same.

Arteor™ square cover plates

| Cat.Nos | Description | MRP* ₹ / Unit | Pack |
|---------|-------------|------------------|------|
|---------|-------------|------------------|------|

Champagne cover plates with Metal frame

| | | | |
|----------------|------------------------------|------|------|
| 5759 88 | Champagne plate - 6 module | 534 | 5/30 |
| 5759 89 | Champagne plate - 8 module | 592 | 5/30 |
| 5759 90 | Champagne plate - 2x4 module | 750 | 2/20 |
| 5759 91 | Champagne plate - 2x6 module | 978 | 2/16 |
| 5759 92 | Champagne plate - 2x8 module | 1108 | 2/16 |
| 5759 93 | Champagne plate - 3x6 module | 1290 | 2/12 |

Dark Bronze cover plates with Metal frame

| | | | |
|----------------|--------------------------------|------|--------|
| 5756 79 | Dark Bronze plate - 1 module | 246 | 10/100 |
| 5756 80 | Dark Bronze plate - 2 module | 258 | 10/100 |
| 5756 81 | Dark Bronze plate - 3 module | 278 | 10/100 |
| 5756 83 | Dark Bronze plate - 4 module | 312 | 5/50 |
| 5756 84 | Dark Bronze plate - 6 module | 534 | 5/30 |
| 5756 85 | Dark Bronze plate - 8 module | 592 | 5/30 |
| 5756 86 | Dark Bronze plate - 2x4 module | 750 | 2/20 |
| 5756 87 | Dark Bronze plate - 2x6 module | 978 | 2/16 |
| 575688 | Dark Bronze plate - 2x8 module | 1108 | 2/16 |
| 5756 89 | Dark Bronze plate - 3x6 module | 1290 | 2/12 |

Pearl aluminium cover plates with Overmoulded frame

| | | | |
|---------|--|------|--------|
| 5757 01 | Pearl aluminium plate - 1 module | 274 | 10/100 |
| 5757 11 | Pearl aluminium plate - 2 module | 288 | 10/100 |
| 5757 21 | Pearl aluminium plate - 3 module | 306 | 10/100 |
| 5757 31 | Pearl aluminium plate - 4 module | 346 | 5/50 |
| 5757 41 | Pearl aluminium plate - 6 module | 594 | 5/30 |
| 5757 51 | Pearl aluminium plate - 8 module | 658 | 5/30 |
| 5757 61 | Pearl aluminium plate - 2x4 module | 834 | 2/20 |
| 5757 71 | Pearl aluminium plate - 2x6 module | 1084 | 2/16 |
| 5757 81 | Pearl aluminium plate - 2x8 module | 1228 | 2/16 |
| 5757 91 | Pearl aluminium plate - 3x6 module | 1436 | 2/12 |
| 5758 01 | Pearl aluminium plate - 3x8 module | 1636 | 2/12 |
| 5750 71 | Pearl aluminium plate for shaver socket 3 module | 468 | 5/50 |

Graphite cover plates with Overmoulded frame

| | | | |
|---------|---|------|--------|
| 5757 02 | Graphite plate - 1 module | 274 | 10/100 |
| 5757 12 | Graphite plate - 2 module | 288 | 10/100 |
| 5757 22 | Graphite plate - 3 module | 306 | 10/100 |
| 5757 32 | Graphite plate - 4 module | 346 | 5/50 |
| 5757 42 | Graphite plate - 6 module | 594 | 5/30 |
| 5757 52 | Graphite plate - 8 module | 658 | 5/30 |
| 5757 62 | Graphite plate - 2x4 module | 834 | 2/20 |
| 5757 72 | Graphite plate - 2x6 module | 1084 | 2/16 |
| 5757 82 | Graphite plate - 2x8 module | 1228 | 2/16 |
| 5757 92 | Graphite plate - 3x6 module | 1436 | 2/12 |
| 5758 02 | Graphite plate - 3x8 module | 1636 | 2/12 |
| 5750 72 | Graphite plate for shaver socket 3 module | 468 | 5/50 |

* MRP - Maximum Retail Price Inclusive of all taxes including GST.
Red Cat.Nos - new products

Arteor™ square cover plates

| Cat.Nos | Description | MRP* ₹ / Unit | Pack |
|---------|-------------|------------------|------|
|---------|-------------|------------------|------|

Magnesium cover plates with Overmoulded frame

| | | | |
|---------|--|------|--------|
| 5758 11 | Magnesium plate - 1 module | 274 | 10/100 |
| 5758 12 | Magnesium plate - 2 module | 288 | 10/100 |
| 5758 13 | Magnesium plate - 3 module | 306 | 10/100 |
| 5758 14 | Magnesium plate - 4 module | 344 | 5/50 |
| 5758 15 | Magnesium plate - 6 module | 592 | 5/30 |
| 5758 16 | Magnesium plate - 8 module | 658 | 5/30 |
| 5758 17 | Magnesium plate - 2x4 module | 834 | 2/20 |
| 5758 18 | Magnesium plate - 2x6 module | 1084 | 2/16 |
| 5758 19 | Magnesium plate - 2x8 module | 1228 | 2/16 |
| 5758 20 | Magnesium plate - 3x6 module | 1436 | 2/12 |
| 5758 21 | Magnesium plate for shaver socket 3 module | 468 | 5/50 |

Champagne cover plates with Overmoulded frame

| | | | |
|----------------|--|------|--------|
| 5758 22 | Champagne plate - 1 module | 274 | 10/100 |
| 5758 23 | Champagne plate - 2 module | 288 | 10/100 |
| 5758 24 | Champagne plate - 3 module | 306 | 10/100 |
| 5758 25 | Champagne plate - 4 module | 344 | 5/50 |
| 5758 26 | Champagne plate - 6 module | 592 | 5/30 |
| 5758 27 | Champagne plate - 8 module | 658 | 5/30 |
| 5758 28 | Champagne plate - 2x4 module | 834 | 2/20 |
| 5758 29 | Champagne plate - 2x6 module | 1084 | 2/16 |
| 5758 30 | Champagne plate - 2x8 module | 1228 | 2/16 |
| 5758 31 | Champagne plate - 3x6 module | 1436 | 2/12 |
| 5758 32 | Champagne plate for shaver socket 3 module | 468 | 5/50 |

Dark Bronze cover plates with Overmoulded frame

| | | | |
|----------------|--|------|--------|
| 5758 33 | Dark Bronze plate - 1 module | 274 | 10/100 |
| 5758 34 | Dark Bronze plate - 2 module | 288 | 10/100 |
| 5758 35 | Dark Bronze plate - 3 module | 306 | 10/100 |
| 5758 36 | Dark Bronze plate - 4 module | 344 | 5/50 |
| 5758 37 | Dark Bronze plate - 6 module | 592 | 5/30 |
| 5758 38 | Dark Bronze plate - 8 module | 658 | 5/30 |
| 5758 39 | Dark Bronze plate - 2x4 module | 834 | 2/20 |
| 5758 40 | Dark Bronze plate - 2x6 module | 1084 | 2/16 |
| 5758 41 | Dark Bronze plate - 2x8 module | 1228 | 2/16 |
| 5758 42 | Dark Bronze plate - 3x6 module | 1436 | 2/12 |
| 5758 43 | Dark Bronze plate for shaver socket 3 module | 468 | 5/50 |

Mirror finish cover plates with Overmoulded frame

| | | | |
|---------|---|------|--------|
| 5757 03 | Mirror black plate - 1 module | 1532 | 1/5/30 |
| 5757 13 | Mirror black plate - 2 module | 1638 | 1/5/30 |
| 5757 23 | Mirror black plate - 3 module | 1758 | 1/20 |
| 5757 33 | Mirror black plate - 4 module | 1866 | 1/20 |
| 5757 43 | Mirror black plate - 6 module | 3398 | 1/5 |
| 5757 53 | Mirror black plate - 8 module | 3740 | 1/5 |
| 5757 63 | Mirror black plate - 2x4 module | 4738 | 1/10 |
| 5757 73 | Mirror black plate - 2x6 module | 5830 | 1/8 |
| 5750 73 | Mirror black plate for shaver socket 3 module | 2406 | 1/5/50 |
| 5757 04 | Mirror white plate - 1 module | 1532 | 1/5/30 |
| 5757 14 | Mirror white plate - 2 module | 1638 | 1/5/30 |
| 5757 24 | Mirror white plate - 3 module | 1758 | 1/20 |
| 5757 34 | Mirror white plate - 4 module | 1866 | 1/20 |
| 5757 44 | Mirror white plate - 6 module | 3398 | 1/5 |
| 5757 54 | Mirror white plate - 8 module | 3740 | 1/5 |

Bold Cat.Nos are products normally available with Legrand (India) Stockists. Cat.Nos that are not bold - delivery within 4 - 8 weeks from the date of order. Bold packing quantity is our mandatory packing. Orders to be placed by Legrand (India) Stockist in multiples of the same.

Arteor™ square cover plates

| Cat.Nos | Description | MRP* ₹ / Unit | Pack |
|---------|-------------|------------------|------|
|---------|-------------|------------------|------|

Mirror finish cover plates with Overmoulded frame

| | | | |
|----------------|---|------|--------|
| 5757 64 | Mirror white plate - 2x4 module | 4830 | 1/10 |
| 5757 74 | Mirror white plate - 2x6 module | 5830 | 1/8 |
| 5750 74 | Mirror white plate for shaver socket 3 module | 2406 | 1/5/50 |
| 5758 44 | Green Apple plate - 1 module | 1532 | 1/5/30 |
| 5758 45 | Green Apple plate - 2 module | 1638 | 1/5/30 |
| 5758 46 | Green Apple plate - 3 module | 1758 | 1/20 |
| 5758 47 | Green Apple plate - 4 module | 1866 | 1/20 |
| 5758 48 | Green Apple plate - 6 module | 3398 | 1/5 |
| 5758 49 | Green Apple plate - 8 module | 3740 | 1/5 |
| 5758 50 | Green Apple plate - 2x4 module | 4828 | 1/10 |
| 5758 51 | Green Apple plate - 2x6 module | 5830 | 1/8 |
| 5758 52 | Green Apple plate for shaver socket 3 module | 2556 | 1/5/50 |

Graphic cover plates with Overmoulded frame

| | | | |
|---------|---|------|--------|
| 5762 91 | Graphic casual plate - 1 module | 1860 | 1/5/30 |
| 5763 11 | Graphic casual plate - 2 module | 2004 | 1/5/30 |
| 5763 31 | Graphic casual plate - 3 module | 2154 | 1/5/20 |
| 5763 51 | Graphic casual plate - 4 module | 2298 | 1/20 |
| 5763 81 | Graphic casual plate - 6 module | 4156 | 1/5 |
| 5764 01 | Graphic casual plate - 8 module | 4584 | 1/5 |
| 5758 89 | Graphic casual plate - 2x4 module | 5774 | 1/10 |
| 5758 90 | Graphic casual plate - 2x6 module | 7150 | 1/8 |
| 5761 61 | Graphic casual for shaver socket 3 module | 2940 | 1/5/50 |

Silver Baroque plates with Overmoulded frame

| | | | |
|---------|---|------|--------|
| 5758 53 | Silver Baroque plate - 1 module | 1860 | 1/5/30 |
| 5758 54 | Silver Baroque plate - 2 module | 2004 | 1/5/30 |
| 5758 55 | Silver Baroque plate - 3 module | 2154 | 1/20 |
| 5758 56 | Silver Baroque plate - 4 module | 2298 | 1/20 |
| 5758 57 | Silver Baroque plate - 6 module | 4156 | 1/5 |
| 5758 58 | Silver Baroque plate - 8 module | 4584 | 1/5 |
| 5758 59 | Silver Baroque plate - 2x4 module | 5774 | 1/10 |
| 5758 60 | Silver Baroque plate - 2x6 module | 7150 | 1/8 |
| 5758 61 | Silver Baroque plate for shaver socket 3 module | 2940 | 1/5/50 |

Dark Baroque plates with Overmoulded frame

| | | | |
|---------|---|------|--------|
| 5758 62 | Dark Baroque plate - 1 module | 1860 | 1/5/30 |
| 5758 63 | Dark Baroque plate - 2 module | 2004 | 1/5/30 |
| 5758 64 | Dark Baroque plate - 3 module | 2154 | 1/20 |
| 5758 65 | Dark Baroque plate - 4 module | 2298 | 1/20 |
| 5758 66 | Dark Baroque plate - 6 module | 4156 | 1/5 |
| 5758 67 | Dark Baroque plate - 8 module | 4584 | 1/5 |
| 5758 68 | Dark Baroque plate - 2x4 module | 5774 | 1/10 |
| 5758 69 | Dark Baroque plate - 2x6 module | 7150 | 1/8 |
| 5758 70 | Dark Baroque plate for shaver socket 3 module | 2940 | 1/5/50 |

Metal finish cover plates with Overmoulded frame

| | | | |
|---------|-----------------------------|------|--------|
| 5762 90 | Gold brass plate - 1 module | 2498 | 1/5/30 |
| 5763 10 | Gold brass plate - 2 module | 2674 | 1/5/30 |

* MRP - Maximum Retail Price Inclusive of all taxes including GST.
Red Cat.Nos - new products

Arteor™ square cover plates

| Cat.Nos | Description | MRP* ₹ / Unit | Pack |
|---------|-------------|------------------|------|
|---------|-------------|------------------|------|

Metal finish cover plates with Overmoulded frame

| | | | |
|---------|--|------|--------|
| 5763 30 | Gold brass plate - 3 module | 2876 | 1/20 |
| 5763 50 | Gold brass plate - 4 module | 3052 | 1/20 |
| 5763 80 | Gold brass plate - 6 module | 5554 | 1/5 |
| 5764 00 | Gold brass plate - 8 module | 6106 | 1/5 |
| 5761 60 | Gold brass plate - for shaver socket 3 module | 3276 | 1/5/50 |
| 5757 06 | Stainless steel plate - 1 module | 2498 | 1/5/30 |
| 5757 16 | Stainless steel plate - 2 module | 2674 | 1/5/30 |
| 5757 26 | Stainless steel plate - 3 module | 2876 | 1/20 |
| 5757 36 | Stainless steel plate - 4 module | 3052 | 1/20 |
| 5757 46 | Stainless steel plate - 6 module | 5554 | 1/5 |
| 5757 66 | Stainless steel plate - 2x4 module | 7720 | 1/10 |
| 5757 56 | Stainless steel plate - 8 module | 6106 | 1/5 |
| 5757 76 | Stainless steel plate - 2x6 module | 9514 | 1/8 |
| 5750 76 | Stainless steel plate - for shaver socket 3 module | 3276 | 1/5/50 |

Wood cover plates with Overmoulded frame

| | | | |
|---------|---|------|--------|
| 5758 80 | Grey Oak plate - 1 module | 1464 | 1/5/30 |
| 5758 81 | Grey Oak plate - 2 module | 1550 | 1/5/30 |
| 5758 82 | Grey Oak plate - 3 module | 1918 | 1/20 |
| 5758 83 | Grey Oak plate - 4 module | 2124 | 1/20 |
| 5758 84 | Grey Oak plate - 6 module | 3156 | 1/5 |
| 5758 85 | Grey Oak plate - 8 module | 3800 | 1/5 |
| 5758 86 | Grey Oak plate - 2x4 module | 4506 | 1/10 |
| 5758 87 | Grey Oak plate - 2x6 module | 6040 | 1/8 |
| 5758 88 | Grey Oak plate for shaver socket 3 module | 1872 | 1/5/50 |

Signature cover plates with Overmoulded frame

| | | | |
|---------|---------------------------------------|-------|--------|
| 5758 71 | Cube plate - 1 module | 4790 | 1/5/30 |
| 5758 72 | Cube plate - 2 module | 4876 | 1/5/30 |
| 5758 73 | Cube plate - 3 module | 5574 | 1/20 |
| 5758 74 | Cube plate - 4 module | 5760 | 1/20 |
| 5758 75 | Cube plate - 6 module | 7504 | 1/5 |
| 5758 76 | Cube plate - 8 module | 7880 | 1/5 |
| 5758 77 | Cube plate - 2x4 module | 11772 | 1/10 |
| 5758 78 | Cube plate - 2x6 module | 13040 | 1/8 |
| 5758 79 | Cube plate for shaver socket 3 module | 5348 | 1/5/50 |

Round cover plates with Metal Frame

White cover plates with Metal frame

| | | | |
|---------|--------------------------|-----|--------|
| 5759 00 | White plate - 2 module | 256 | 10/100 |
| 5759 10 | White plate - 3 module | 266 | 10/100 |
| 5759 20 | White plate - 4 module | 282 | 5/50 |
| 5759 30 | White plate - 6 module | 514 | 5/30 |
| 5765 80 | White plate - 8 module | 568 | 5/30 |
| 5759 40 | White plate - 2x4 module | 602 | 2/20 |
| 5759 50 | White plate - 2x6 module | 878 | 2/16 |

Pearl Aluminium cover plates with Metal frame

| | | | |
|----------------|------------------------------------|------|--------|
| 5757 93 | Pearl Aluminium plate - 2 module | 336 | 10/100 |
| 5757 94 | Pearl Aluminium plate - 3 module | 360 | 10/100 |
| 5757 95 | Pearl Aluminium plate - 4 module | 408 | 5/50 |
| 5757 96 | Pearl Aluminium plate - 6 module | 698 | 5/30 |
| 5757 97 | Pearl Aluminium plate - 8 module | 772 | 5/30 |
| 5757 98 | Pearl Aluminium plate - 2x4 module | 976 | 2/20 |
| 5757 99 | Pearl Aluminium plate - 2x6 module | 1270 | 2/16 |

Bold Cat.Nos are products normally available with Legrand (India) Stockists. Cat.Nos that are not bold - delivery within 4 - 8 weeks from the date of order. Bold packing quantity is our mandatory packing. Orders to be placed by Legrand (India) Stockist in multiples of the same.

Arteor™ round cover plates

| Cat.Nos | Description | MRP* ₹ / Unit | Pack |
|---------|-------------|------------------|------|
|---------|-------------|------------------|------|

Graphite cover plates with Metal frame

| | | | |
|---------|-----------------------------|------|--------|
| 5758 03 | Graphite plate - 2 module | 336 | 10/100 |
| 5758 04 | Graphite plate - 3 module | 360 | 10/100 |
| 5758 05 | Graphite plate - 4 module | 408 | 5/50 |
| 5758 06 | Graphite plate - 6 module | 698 | 5/30 |
| 5758 07 | Graphite plate - 8 module | 772 | 5/30 |
| 5758 08 | Graphite plate - 2x4 module | 976 | 2/20 |
| 5758 09 | Graphite plate - 2x6 module | 1270 | 2/16 |

Magnesium cover plates with Metal frame

| | | | |
|---------|------------------------------|------|--------|
| 5756 23 | Magnesium plate - 2 module | 336 | 10/100 |
| 5756 24 | Magnesium plate - 3 module | 360 | 10/100 |
| 5756 25 | Magnesium plate - 4 module | 406 | 5/50 |
| 5756 26 | Magnesium plate - 6 module | 696 | 5/30 |
| 5756 27 | Magnesium plate - 8 module | 772 | 5/30 |
| 5756 28 | Magnesium plate - 2x4 module | 976 | 2/20 |
| 5756 29 | Magnesium plate - 2x6 module | 1270 | 2/16 |

Champagne cover plates with Metal frame

| | | | |
|---------|------------------------------|------|--------|
| 5758 91 | Champagne plate - 2 module | 336 | 10/100 |
| 5758 92 | Champagne plate - 3 module | 360 | 10/100 |
| 5758 93 | Champagne plate - 4 module | 406 | 5/50 |
| 5758 94 | Champagne plate - 6 module | 696 | 5/30 |
| 5758 95 | Champagne plate - 8 module | 772 | 5/30 |
| 5758 96 | Champagne plate - 2x4 module | 976 | 2/20 |
| 5758 97 | Champagne plate - 2x6 module | 1270 | 2/16 |

Dark Bronze cover plates with Metal frame

| | | | |
|---------|--------------------------------|------|--------|
| 5756 93 | Dark Bronze plate - 2 module | 336 | 10/100 |
| 5756 94 | Dark Bronze plate - 3 module | 360 | 10/100 |
| 5756 95 | Dark Bronze plate - 4 module | 406 | 5/50 |
| 5756 96 | Dark Bronze plate - 6 module | 696 | 5/30 |
| 5756 97 | Dark Bronze plate - 8 module | 772 | 5/30 |
| 5756 98 | Dark Bronze plate - 2x4 module | 976 | 2/20 |
| 5756 99 | Dark Bronze plate - 2x6 module | 1270 | 2/16 |

Pearl aluminium cover plates with Overmoulded frame

| | | | |
|---------|------------------------------------|------|--------|
| 5759 01 | Pearl aluminium plate - 2 module | 380 | 10/100 |
| 5759 11 | Pearl aluminium plate - 3 module | 400 | 10/100 |
| 5759 21 | Pearl aluminium plate - 4 module | 426 | 5/50 |
| 5759 31 | Pearl aluminium plate - 6 module | 772 | 5/30 |
| 5765 81 | Pearl aluminium plate - 8 module | 850 | 5/30 |
| 5759 41 | Pearl aluminium plate - 2x4 module | 892 | 2/20 |
| 5759 51 | Pearl aluminium plate - 2x6 module | 1322 | 2/16 |

Graphite cover plates with Overmoulded frame

| | | | |
|---------|-----------------------------|------|--------|
| 5759 02 | Graphite plate - 2 module | 380 | 10/100 |
| 5759 12 | Graphite plate - 3 module | 400 | 10/100 |
| 5759 22 | Graphite plate - 4 module | 426 | 5/50 |
| 5759 32 | Graphite plate - 6 module | 772 | 5/30 |
| 5765 82 | Graphite plate - 8 module | 850 | 5/30 |
| 5759 42 | Graphite plate - 2x4 module | 892 | 2/20 |
| 5759 52 | Graphite plate - 2x6 module | 1322 | 2/16 |

Magnesium cover plates with Overmoulded frame

| | | | |
|---------|----------------------------|-----|--------|
| 5768 41 | Magnesium plate - 2 module | 380 | 10/100 |
| 5768 42 | Magnesium plate - 3 module | 402 | 10/100 |
| 5768 43 | Magnesium plate - 4 module | 428 | 5/50 |

* MRP - Maximum Retail Price Inclusive of all taxes including GST.
Red Cat.Nos - new products

Arteor™ square cover plates

| Cat.Nos | Description | MRP* ₹ / Unit | Pack |
|---------|-------------|------------------|------|
|---------|-------------|------------------|------|

Magnesium cover plates with Overmoulded frame

| | | | |
|---------|------------------------------|------|------|
| 5768 44 | Magnesium plate - 6 module | 772 | 5/30 |
| 5768 45 | Magnesium plate - 8 module | 850 | 5/30 |
| 5768 46 | Magnesium plate - 2x4 module | 892 | 2/20 |
| 5768 47 | Magnesium plate - 2x6 module | 1320 | 2/16 |

Champagne cover plates with Overmoulded frame

| | | | |
|---------|------------------------------|------|--------|
| 5768 48 | Champagne plate - 2 module | 380 | 10/100 |
| 5768 49 | Champagne plate - 3 module | 402 | 10/100 |
| 5768 50 | Champagne plate - 4 module | 428 | 5/50 |
| 5768 51 | Champagne plate - 6 module | 772 | 5/30 |
| 5768 52 | Champagne plate - 8 module | 850 | 5/30 |
| 5768 53 | Champagne plate - 2x4 module | 892 | 2/20 |
| 5768 54 | Champagne plate - 2x6 module | 1320 | 2/16 |

Dark Bronze cover plates with Overmoulded frame

| | | | |
|---------|--------------------------------|------|--------|
| 5768 55 | Dark Bronze plate - 2 module | 380 | 10/100 |
| 5768 56 | Dark Bronze plate - 3 module | 402 | 10/100 |
| 5768 57 | Dark Bronze plate - 4 module | 428 | 5/50 |
| 5768 58 | Dark Bronze plate - 6 module | 772 | 5/30 |
| 5768 59 | Dark Bronze plate - 8 module | 850 | 5/30 |
| 5768 60 | Dark Bronze plate - 2x4 module | 892 | 2/20 |
| 5768 61 | Dark Bronze plate - 2x6 module | 1320 | 2/16 |

Mirror finish cover plates with Overmoulded frame

| | | | |
|---------|---------------------------------|------|--------|
| 5759 03 | Mirror black plate - 2 module | 1812 | 1/5/30 |
| 5759 13 | Mirror black plate - 3 module | 1936 | 1/20 |
| 5759 23 | Mirror black plate - 4 module | 2060 | 1/20 |
| 5759 33 | Mirror black plate - 6 module | 3730 | 1/5 |
| 5765 83 | Mirror black plate - 8 module | 4120 | 1/5 |
| 5759 43 | Mirror black plate - 2x4 module | 4858 | 1/10 |
| 5759 53 | Mirror black plate - 2x6 module | 6422 | 1/8 |
| 5759 04 | Mirror white plate - 2 module | 1812 | 1/5/30 |
| 5759 14 | Mirror white plate - 3 module | 1936 | 1/20 |
| 5759 24 | Mirror white plate - 4 module | 2060 | 1/20 |
| 5759 34 | Mirror white plate - 6 module | 3730 | 1/5 |
| 5765 84 | Mirror white plate - 8 module | 4120 | 1/5 |
| 5759 44 | Mirror white plate - 2x4 module | 4958 | 1/10 |
| 5759 54 | Mirror white plate - 2x6 module | 6422 | 1/8 |
| 5768 62 | Green Apple plate - 2 module | 1812 | 1/5/30 |
| 5768 63 | Green Apple plate - 3 module | 1936 | 1/20 |
| 5768 64 | Green Apple plate - 4 module | 2060 | 1/20 |
| 5768 65 | Green Apple plate - 6 module | 3730 | 1/5 |
| 5768 66 | Green Apple plate - 8 module | 4120 | 1/5 |
| 5768 67 | Green Apple plate - 2x4 module | 4958 | 1/10 |
| 5768 68 | Green Apple plate - 2x6 module | 6422 | 1/8 |

Graphic cover plates with overmoulded frames

| | | | |
|---------|-----------------------------------|------|--------|
| 5763 01 | Graphic casual plate - 2 module | 2208 | 1/5/30 |
| 5763 21 | Graphic casual plate - 3 module | 2364 | 1/20 |
| 5763 41 | Graphic casual plate - 4 module | 2520 | 1/20 |
| 5763 61 | Graphic casual plate - 6 module | 4578 | 1/5 |
| 5763 91 | Graphic casual plate - 8 module | 5038 | 1/5 |
| 5768 97 | Graphic casual plate - 2x4 module | 6048 | 1/10 |
| 5768 98 | Graphic casual plate - 2x6 module | 7860 | 1/8 |

Bold Cat.Nos are products normally available with Legrand (India) Stockists.
Cat.Nos that are not bold - delivery within 4 - 8 weeks from the date of order.
Bold packing quantity is our mandatory packing. Orders to be placed by Legrand (India) Stockist in multiples of the same.

Arteor™ round cover plates

| Cat.Nos | Description | MRP* ₹ / Unit | Pack |
|---------|-------------|------------------|------|
|---------|-------------|------------------|------|

Round cover plates Silver Baroque cover plates with Overmoulded frame

| | | | |
|---------|-----------------------------------|------|--------|
| 5768 69 | Silver Baroque plate - 2 module | 2208 | 1/5/30 |
| 5768 70 | Silver Baroque plate - 3 module | 2364 | 1/20 |
| 5768 71 | Silver Baroque plate - 4 module | 2520 | 1/20 |
| 5768 72 | Silver Baroque plate - 6 module | 4578 | 1/5 |
| 5768 73 | Silver Baroque plate - 8 module | 5038 | 1/5 |
| 5768 74 | Silver Baroque plate - 2x4 module | 6048 | 1/10 |
| 5768 75 | Silver Baroque plate - 2x6 module | 7860 | 1/8 |

Dark Baroque cover plates with Overmoulded frame

| | | | |
|---------|---------------------------------|------|--------|
| 5768 76 | Dark Baroque plate - 2 module | 2208 | 1/5/30 |
| 5768 77 | Dark Baroque plate - 3 module | 2364 | 1/20 |
| 5768 78 | Dark Baroque plate - 4 module | 2520 | 1/20 |
| 5768 79 | Dark Baroque plate - 6 module | 4578 | 1/5 |
| 5768 80 | Dark Baroque plate - 8 module | 5038 | 1/5 |
| 5768 81 | Dark Baroque plate - 2x4 module | 6048 | 1/10 |
| 5768 82 | Dark Baroque plate - 2x6 module | 7860 | 1/8 |

Metal finish cover plates with Overmoulded frame

| | | | |
|---------|------------------------------------|-------|--------|
| 5763 00 | Gold brass plate - 2 module | 2946 | 1/5/30 |
| 5763 20 | Gold brass plate - 3 module | 3148 | 1/20 |
| 5763 40 | Gold brass plate - 4 module | 3360 | 1/20 |
| 5763 60 | Gold brass plate - 6 module | 6102 | 1/5 |
| 5763 90 | Gold brass plate - 8 module | 6722 | 1/5 |
| 5759 06 | Stainless steel plate - 2 module | 2946 | 1/5/30 |
| 5759 16 | Stainless steel plate - 3 module | 3148 | 1/20 |
| 5759 26 | Stainless steel plate - 4 module | 3360 | 1/20 |
| 5759 36 | Stainless steel plate - 6 module | 6102 | 1/5 |
| 5765 86 | Stainless steel plate - 8 module | 6722 | 1/5 |
| 5759 46 | Stainless steel plate - 2x4 module | 8504 | 1/10 |
| 5759 56 | Stainless steel plate - 2x6 module | 10464 | 1/8 |

Wood cover plates with Overmoulded frame

| | | | |
|---------|-----------------------------|------|--------|
| 5768 90 | Grey Oak plate - 2 module | 1550 | 1/5/30 |
| 5768 91 | Grey Oak plate - 3 module | 2294 | 1/20 |
| 5768 92 | Grey Oak plate - 4 module | 2380 | 1/20 |
| 5768 93 | Grey Oak plate - 6 module | 3378 | 1/5 |
| 5768 94 | Grey Oak plate - 8 module | 4116 | 1/5 |
| 5768 95 | Grey Oak plate - 2x4 module | 4400 | 1/10 |
| 5768 96 | Grey Oak plate - 2x6 module | 5634 | 1/8 |

Signature cover plates with Overmoulded frame

| | | | |
|---------|-------------------------|-------|--------|
| 5768 83 | Cube plate - 2 module | 4876 | 1/5/30 |
| 5768 84 | Cube plate - 3 module | 5928 | 1/20 |
| 5768 85 | Cube plate - 4 module | 6036 | 1/20 |
| 5768 86 | Cube plate - 6 module | 7726 | 1/5 |
| 5768 87 | Cube plate - 8 module | 8194 | 1/5 |
| 5768 88 | Cube plate - 2x4 module | 11400 | 1/10 |
| 5768 89 | Cube plate - 2x6 module | 12900 | 1/8 |

* MRP - Maximum Retail Price Inclusive of all taxes including GST.
Red Cat.Nos - new products

Arteor™ round cover plates

| Cat.Nos | Description | MRP* ₹ / Unit | Pack |
|---------|-------------|------------------|------|
|---------|-------------|------------------|------|

Accessories

Plastic surface boxes

| | | | |
|---------|----------------------------|-----|-------|
| 5734 91 | Surface box - 1/2 module | 102 | 10/50 |
| 5735 20 | Surface box - 3 module | 126 | 5/35 |
| 5735 70 | Surface box - 4 module | 154 | 5/25 |
| 5735 71 | Surface box - 6 module | 186 | 1/10 |
| 5723 94 | Surface box - 8 module | 208 | 1/10 |
| 5735 74 | Surface box - 2x4 module | 256 | 2/10 |
| 5735 72 | Surface box - 12/16 module | 650 | 2/10 |
| 5735 73 | Surface box - 18/24 module | 690 | 2/8 |

Metal flush boxes

| | | | |
|---------|---|-----|----|
| 6890 07 | Metal flush mounting Box - 1/2 module | 102 | 40 |
| 6890 08 | Metal flush mounting Box - 3 module | 102 | 40 |
| 6890 09 | Metal flush mounting Box - 4 module | 138 | 40 |
| 6890 10 | Metal flush mounting Box - 6 module | 218 | 40 |
| 6890 42 | Metal flush mounting Box - 8 module | 256 | 40 |
| 6890 31 | Metal flush mounting Box - 4x2 module | 254 | 20 |
| 6890 11 | Metal flush mounting Box - 12 /16 module | 384 | 10 |
| 6890 12 | Metal flush mounting Box - 18 / 24 module | 484 | 10 |

IP 55 Plexo box and accessories

| | | | |
|---------|---|------|--------|
| 0696 51 | Grey Plexo box for 2 module | 272 | 10/100 |
| 0696 72 | Grey Plexo box for 2 x 2 module use two nos. of 0695 80 | 884 | 5/50 |
| 0696 80 | use two nos. of 0695 80 Grey Plexo box for 2 x 2 x 2 module | 1186 | 5/25 |
| 0696 89 | White Plexo box for 2 module | 332 | 10/100 |

IP 55 Plexo box and accessories

| | | | |
|---------|---|------|--------|
| 0695 80 | Grey/White adaptor for IP 55 Plexo with smoked polycarbonate flap for 2 modules | 1016 | 10/100 |
| 6846 38 | Grey Plexo box & adaptor with transparent flap for 3 modules, IP 66 | 4062 | 1 |

IP 55 Plexo box with PVC membrane

| | | | |
|---------|---|------|----|
| 6806 11 | Grey Plexo box & adaptor with PVC membrane - 1 module | 894 | 10 |
| 6806 12 | Grey Plexo box & adaptor with PVC membrane - module | 916 | 10 |
| 6806 13 | Grey Plexo box & adaptor with PVC membrane - module | 1218 | 10 |
| 6806 14 | Grey Plexo box & adaptor with PVC membrane - 4 module | 1826 | 5 |
| 6806 19 | Grey Plexo box & adaptor with PVC membrane - 2 row x 4 module | 2966 | 5 |
| 6806 33 | Grey Plexo flush adaptor with membrane for 3 module Arteor™ box | 976 | 20 |



5735 70



6890 07



6890 08



6890 09



6890 10



0695 80



6846 38



6806 12



6806 13



6806 19



6806 33

Bold Cat.Nos are products normally available with Legrand (India) Stockists. Cat.Nos that are not bold - delivery within 4 - 8 weeks from the date of order. Bold packing quantity is our mandatory packing. Orders to be placed by Legrand (India) Stockist in multiples of the same.

MYRIUS™

MORE IS ON



The Myrius's range of plates is crafted with unique features & flawless designs, it perfectly defines aestheticism. These minimalistic and flawless designs are available in neutral tones of grainy matte black and glossy white to suit any décor.



Black Beauty

A mystic black shade with a grainy matte finish truly complements any décor.



Snowy White

Its gleaming white shade and a perfect glossy finish creates a soothing décor.



MORE AESTHETICS

Flat, sleek and smooth, Myrius with its curved edges gives it a distinct and appealing look to everyone. Moreover, its minimalistic design makes it look absolutely stunning and desirable. But what makes Myrius truly beautiful is a classic black and white shade that offers an aura of comfort and timelessness.



VSP - Voltage Surge protectors

- Protects electrical devices like laptops, computers, printers and other office equipments from voltage surge
- Blends very well with the modular range of wiring devices



Motion sensor

- Infrared detectors that detect human movements
- Programmed to automatically switch the device on and switch off when not in use, thus, saves energy



Motor Starter

- Complete protection against overload
- Aesthetically appealing
- For ACs/Geysers etc.



Skirting light

- Fitted into the walls at skirting level
- Provides a dim lighting
- Creates a path light during night
- Uses LEDs that saves energy



Remote control switch for light and fan

- Can control 4 lights & 1 fan
- 10 different speed options for fan
- Night lamp on product panel with manual operation option for all functions

MYRIUS™

MORE IS ON

Myrius range of wiring accessories is a classic creation to increase the customer's comfort and improve the work environment. This wide range of innovative products offers solutions for residential, commercial and hospitality projects, thus making it a range that caters to everyone's needs.



Fan regulator



TV/SAT/FM socket



Telephone Socket



Light Marking



AV Connector



RJ 45 Data Socket



Projector connector



Key Fob Switch



Do not disturb Switch



Shaver socket



USB Charger



Modular MCB



Myrius™ mechanisms - white

| Cat.Nos | Description | MRP* ₹ / Unit | Pack |
|---------|-------------|------------------|------|
|---------|-------------|------------------|------|

Switches - 6 A - 230 VA

| | | | |
|---------|--|-----|--------|
| 6730 00 | 6 A switch 1 W - 1 module | 128 | 20/200 |
| 6730 01 | 6 A switch 2 W - 1 module | 198 | 20/200 |
| 6730 02 | 6 A switch 1 W - 1 module with indicator | 182 | 20/200 |
| 6730 03 | 6 A switch 1 W - 1 module with "Light" marking | 156 | 20/200 |
| 6730 04 | 6 A switch 1 W - 1 module with "Fan" marking | 156 | 20/200 |

Switches - 10 A - 230 VA

| | | | |
|---------|---|------|--------|
| 6730 05 | 10 A switch 1 W - 2 module | 230 | 10/100 |
| 6730 06 | 10 A switch 2 W - 2 module | 270 | 10/100 |
| 6730 17 | 10 A intermediate - 2 module | 1480 | 10/100 |
| 6730 07 | 10 A switch 1 W with indicator - 2 module | 284 | 10/100 |

Switches - 16 A - 230 VA

| | | | |
|---------|---|-----|--------|
| 6730 08 | 16 A switch 1 W - 1 module | 258 | 20/200 |
| 6730 09 | 16 A switch 2 W - 1 module | 296 | 20/200 |
| 6730 10 | 16 A switch 1 W with indicator - 1 module | 314 | 20/200 |

Switches - 20 A - 230 VA

| | | | |
|---------|--|-----|--------|
| 6730 11 | 20 A 1 W switch - 1 module | 342 | 20/200 |
| 6730 12 | 20 A DP 1 W switch - 2 module | 524 | 10/100 |
| 6730 13 | 20 A DP 1 W switch with indicator - 2 module | 556 | 10/100 |
| 6730 14 | 20 A 2 W switch - 2 module | 578 | 10/100 |

Switches - 25 A - 230 VA

| | | | |
|---------|--|-----|--------|
| 6730 15 | 25 A SP 1 W switch with indicator - 1 module | 384 | 20/200 |
|---------|--|-----|--------|

Switches - 32 A - 230 VA

| | | | |
|---------|--|-----|--------|
| 6730 16 | 32 A DP switch with indicator - 2 module | 858 | 10/100 |
|---------|--|-----|--------|

* MRP - Maximum Retail Price Inclusive of all taxes including GST.

Myrius™ mechanisms - white

| Cat.Nos | Description | MRP* ₹ / Unit | Pack |
|---------|-------------|------------------|------|
|---------|-------------|------------------|------|

Push buttons

| | | | |
|---------|--|-----|--------|
| 6730 18 | 6 A push button SP - 1 module | 220 | 20/200 |
| 6730 19 | 6 A push button SP with indicator - 1 module | 284 | 20/200 |
| 6730 20 | 6 A bell push - 1 module | 216 | 20/200 |
| 6730 21 | 6 A bell push with indicator - 1 module | 284 | 20/200 |
| 6730 22 | 6 A bell push - 2 module | 328 | 10/100 |
| 6730 23 | 6 A bell push with indicator - 2 module | 384 | 10/100 |

Accessories for switches with indicator

| | | | |
|---------|----------------------------------|----|------|
| 6732 44 | Lamp for switches / push buttons | 48 | 5/50 |
|---------|----------------------------------|----|------|

Socket - 230 VA

| | | | |
|---------|--|-----|--------|
| 6730 41 | 6/16 A 2 Pin Euro US socket - 1 module | 300 | 20/200 |
| 6730 42 | 16 A 3 Pin switched socket - 3 module | 978 | 5/50 |
| 6730 43 | Multistandard socket 6/10/13 A - 2/3 pin for 250 V AC 15 A for 127 V type - 2 pin 2 module | 328 | 10/100 |
| 6730 44 | 6 A 5 Pin universal socket - 2 module | 282 | 20/200 |
| 6730 83 | 6/16 A socket - 3 module | 456 | 5/50 |
| 6730 45 | 6/16 A socket - 2 module | 382 | 10/100 |
| 6730 46 | 6/16 A - Euro socket - 2 module | 438 | 10/100 |
| 6730 47 | 25 A socket - 2 module | 482 | 10/100 |

Power unit

| | | | |
|---------|--|------|------|
| 6730 74 | Power strip - 8 module 6 A (2 nos.) + 16 A socket (1 no.) + 16 A switch with indicator (1 no.) | 2230 | 1/10 |
| 6730 75 | Power strip - 8 module 5 Pin 6 A (3 nos.) + 16 A switch with indicator (1 no.) | 1750 | 1/10 |
| 6730 76 | Power strip - 8 module multistd socket (3 nos.) + 16 A switch (1 no.) | 1724 | 1/10 |

Bold Cat.Nos are products normally available with Legrand (India) Stockists. Cat.Nos that are not bold - delivery within 4 - 8 weeks from the date of order. Bold packing quantity is our mandatory packing. Orders to be placed by Legrand (India) Stockist in multiples of the same.

Myrius™ mechanisms - white

| Cat.Nos | Description | MRP* ₹ / Unit | Pack |
|---------|-------------|------------------|------|
|---------|-------------|------------------|------|

Dimmer & regulator

| | | | |
|---------|--|------|----------|
| 6730 24 | Rotary dimmer 400 W - 1 module | 946 | 1/5/50 |
| 6730 25 | Rotary dimmer 650 W - 3 module | 1984 | 1/10 |
| 6730 26 | Compact fluorescent lamp dimmer - 2 module | 2630 | 1/10 |
| 6730 27 | Fan step regulator 100 W - 1 module | 736 | 1/5/50 |
| 6730 29 | Fan step regulator 100 W - 2 module | 844 | 1/10/100 |
| 6730 28 | Fan step regulator 120 W - 2 module | 912 | 1/10/100 |
| 6730 77 | Fan step regulator - 2 module for energy saving fans | 884 | 1/10/100 |

Electronic touch dimmer

| | | | |
|---------|----------------------------|------|------|
| 6731 38 | Universal touch dimmer 3 M | 6126 | 1/10 |
|---------|----------------------------|------|------|

Emergency light

| | | | |
|---------|---------------------------------|------|-----|
| 0785 12 | Emergency light unit - 2 module | 5892 | 1/1 |
|---------|---------------------------------|------|-----|

Indicators

| | | | |
|---------|---|-----|-----|
| 0785 73 | Triangular bulkhead - Blue - 2 module | 258 | 1/1 |
| 0785 71 | Triangular bulkhead - colourless - 2 module | 258 | 1/1 |
| 0785 72 | Triangular bulkhead - green - 2 module | 282 | 1/1 |
| 0785 70 | Triangular bulkhead - red - 2 module | 282 | 1/1 |

Skirting light

| | | | |
|---------|--|-----|--------|
| 6730 36 | Skirting light with white LED - 3 module | 714 | 1/5/25 |
|---------|--|-----|--------|

Bell indicator

| | | | |
|---------|------------------------------------|------|--------|
| 6730 33 | Bell indicator - 240 VA - 1 module | 1034 | 20/200 |
|---------|------------------------------------|------|--------|

Buzzer

| | | | |
|---------|----------------------------|------|--------|
| 6730 34 | Buzzer - 230 VA - 1 module | 1018 | 20/200 |
|---------|----------------------------|------|--------|

Remote unit

| | | | |
|---------|----------------------------------|------|--------|
| 6730 73 | Remote control switch - 4 module | 7270 | 1/5/20 |
|---------|----------------------------------|------|--------|

Hospitality functions

Key FOB switch

| | | | |
|---------|--|------|----------|
| 6730 37 | 15 A key card switch monobloc with plate - 2 M | 3410 | 1/10 |
| 6732 37 | 15 A key card switch monobloc with new plate - 2 M White | 3756 | 1/10 |
| 6730 38 | Only key fob for switch Cat.Nos 6730 37 & 6732 37 | 164 | 1/10/100 |

* MRP - Maximum Retail Price Inclusive of all taxes including GST.
 † To be Introduced Shortly

Myrius™ mechanisms - white

| Cat.Nos | Description | MRP* ₹ / Unit | Pack |
|---------|-------------|------------------|------|
|---------|-------------|------------------|------|

"Do Not Distrub" and MMR control unit

| | | | |
|---------|----------------------------|------|--------|
| 6730 39 | External unit - 1+1 module | 1454 | 10/100 |
| 6730 40 | Internal unit - 1+1 module | 972 | 10/100 |

Shaver socket

| | | | |
|---------|---|------|--------|
| 6730 49 | Shaver Socket 230 V / 120 - 230 V monobloc with plate - 4 M | 4292 | 1/5/20 |
| 6730 79 | Shaver Socket 230 V / 120 - 230 V monobloc with new plate - 4 M White | 4500 | 1/5 |

Sockets and connectors

TV socket

| | | | |
|---------|--|------|--------|
| 6730 50 | TV socket - 1 module | 190 | 20/200 |
| 6730 51 | TV / Sat / FM 6 shielded socket 2 module | 1696 | 10/100 |

Data & voice

| | | | |
|---------|--|-----|--------|
| 6730 52 | RJ-11 telephone socket with transparent shutter 1 module | 188 | 20/200 |
| 6730 53 | RJ-11 double telephone socket with shutter 1 module | 288 | 20/200 |
| 6730 54 | UTP cat 5e information outlets toolless system 1 module | 442 | 20/200 |
| 6730 55 | UTP cat 6 - 1 module | 656 | 20/200 |
| 6730 56 | UTP cat 6 - 2 module | 668 | 10/100 |

USB chargers (IS13252 (Part 1) / IEC 60950-1)

| | | | |
|----------|------------------------------|------|----------|
| 6730 80 | USB Charger 1M 1000mA | 1152 | 10/100 |
| 6731 62† | USB Charger 1M 1500mA | 1324 | 10/100 |
| 6731 78 | Double USB Charger 2M 2400mA | 1856 | 1/10/100 |

Audio & video connector

| | | | |
|---------|-----------------------------|------|--------|
| 6730 57 | 3 x female RCA 1 module | 2546 | 1/10 |
| 6730 58 | 3 pole XLR sockets 2 module | 2456 | 10/100 |
| 6730 59 | Female HD 15 - 2 module | 3024 | 1/10 |

Sound (Volume controller)

| | | | |
|---------|---|------|----------|
| 6730 63 | Suitable for 8 Ohms, 3 Watts (RNS) speaker - 2 module | 1214 | 1/10/100 |
|---------|---|------|----------|

Protectors and accessories

Motor starter

| | | | |
|---------|-----------------------------|-----|----------|
| 6730 30 | 16 A motor starter 2 module | 608 | 1/10/100 |
| 6730 31 | 25 A motor starter 2 module | 622 | 1/10/100 |

Modular MCB (IS : 60898-1:2002)

| | | | |
|---------|------------------------|-----|----------|
| 6730 64 | 16 A MCB SP 1M C curve | 368 | 1/10/100 |
| 6730 65 | 20 A MCB SP 1M C curve | 368 | 1/10/100 |
| 6732 05 | 25 A MCB SP 1M C curve | 368 | 1/10/100 |
| 6732 07 | 32A MCB SP 1M C curve | 368 | 1/10/100 |

Bold Cat.Nos are products normally available with Legrand (India) Stockists. Cat.Nos that are not bold - delivery within 4 - 8 weeks from the date of order. Bold packing quantity is our mandatory packing. Orders to be placed by Legrand (India) Stockist in multiples of the same.

Myrius™
mechanisms - white

| Cat.Nos | Description | MRP* ₹ / Unit | Pack |
|---------|-------------|------------------|------|
|---------|-------------|------------------|------|

RCBO

| | | | |
|---------|--|------|-----|
| 6730 78 | Single pole + Neutral - 30 mA, 16 A - 230 VA 2 module | 8098 | 1/1 |
|---------|--|------|-----|

VSP

| | | | |
|---------|---|------|--------|
| 6730 70 | Surge filter (VSP) - 230 VA 1 module | 2480 | 20/200 |
|---------|---|------|--------|

Accessories

| | | | |
|---------|------------------------------------|-----|--------|
| 6730 60 | Cable outlet - 8 mm 1 module | 234 | 20/200 |
| 6730 61 | Blanking plate - 1 module | 42 | 20/200 |
| 6730 62 | Blanking plate - 2 module | 48 | 10/100 |
| 0802 90 | Panel mounting support 1 module | 220 | 10/200 |
| 0802 91 | Panel mounting support 2 module | 226 | 10/200 |

Myrius antibacterial switches & accessories - white

| | | | |
|---------|--|------|----------|
| 6730 84 | 6 A switch 1 W - 1 module | 176 | 20/200 |
| 6730 85 | 6 A switch 2 W - 1 module | 234 | 20/200 |
| 6730 86 | 6 A bell push - 1 module | 262 | 20/200 |
| 6730 89 | 16 A switch 1 way - 1 module | 314 | 20/200 |
| 6730 90 | 16 A switch 2 way - 1 module | 362 | 20/200 |
| 6730 92 | Fan regulator 120 W - 2 module | 1120 | 1/10/100 |
| 6730 93 | Multistandard socket - 2 module | 392 | 10/100 |
| 6730 94 | 6 A 5 pin universal socket 2 module | 340 | 20/200 |
| 6730 95 | 6/16 A socket - 3 module | 556 | 5/50 |
| 0787 00 | Equipotential socket 1 module antibacterial | 1644 | 1/10 |
| 6730 98 | T.V. socket - 1 module | 230 | 20/200 |
| 6730 99 | RJ -11 telephone socket - 1 module | 230 | 20/200 |
| 6730 81 | RJ-45 Cat 6 UTP - 1 module | 804 | 20/200 |
| 6730 82 | Blanking plate - 1 module | 42 | 20/200 |
| 6732 45 | 1 module plate + frame 1 module | 168 | 20/200 |
| 6732 46 | 2 module plate + frame 2 module | 186 | 20/200 |
| 6732 47 | 3 module plate + frame 3 module | 198 | 10/100 |
| 6732 48 | 4 module plate + frame 4 module | 214 | 10/100 |

* MRP - Maximum Retail Price Inclusive of all taxes including GST.

MYRIUS ANTI-BACTERIAL

MORE FOR YOUR WELLNESS



Myrius anti-bacterial products offer anti-bacterial protection. The composition of the product contain Ag+ ions that eliminates the proliferation of bacteria on contact with the surface of the product. It has a smooth and straight design that facilitates in reducing the dust accumulation. It is self disinfecting throughout its lifespan.

- Extremely useful in agri-food premises, healthcare environments & premises with high risk in terms of people's fragility.
- Special protection for the health and hygiene market in the form of an equipotential socket for earthing devices, application to connection of hospital beds and trolleys to medical apparatus to avoid all risk of potential difference during the medical care.

Myrius™ mechanisms - white

| Cat.Nos | Description | MRP* ₹ / Unit | Pack |
|---------|-------------|------------------|------|
|---------|-------------|------------------|------|

Myrius antibacterial switches & accessories - white

| | | | |
|---------|--|-----|------|
| 6732 49 | 8 module plate + frame (horizontal) 8 module | 410 | 5/50 |
| 6732 50 | 8 module plate + frame (4x2) 8 module | 516 | 5/25 |
| 6732 52 | 16 module plate + frame 16 module | 716 | 1/10 |

Myrius™ mechanisms - black Switches – 6 A - 230 VA

| | | | |
|---------|--|-----|--------|
| 6731 00 | 6 A switch 1 W 1 module | 156 | 20/200 |
| 6731 01 | 6 A switch 2 W 1 module | 220 | 20/200 |
| 6731 02 | 6 A switch 1 W with indicator - 1 module | 242 | 20/200 |
| 6731 03 | 6 A switch 1 W with "Light" marking 1 module | 186 | 20/200 |
| 6731 04 | 6 A switch 1 W with "Fan" marking 1 module | 186 | 20/200 |

Switches – 10 A - 230 VA

| | | | |
|---------|---|------|--------|
| 6731 05 | 10 A switch 1 W 2 module | 276 | 10/100 |
| 6731 06 | 10 A switch 2 W 2 module | 296 | 10/100 |
| 6731 17 | 10 A intermediate switch 2 module | 1706 | 10/100 |
| 6731 07 | 10 A switch 1 W with indicator - 2 module | 316 | 10/100 |

Switches – 16 A - 230 VA

| | | | |
|---------|---|-----|--------|
| 6731 08 | 16 A switch 1 way 1 module | 288 | 20/200 |
| 6731 09 | 16 A switch 2 way 1 module | 348 | 20/200 |
| 6731 10 | 16 A switch 1 way with indicator - 1 module | 362 | 20/200 |

Switches – 20 A - 230 VA

| | | | |
|---------|--|-----|--------|
| 6731 11 | 20 A 1 W switch 1 module | 388 | 20/200 |
| 6731 12 | 20 A DP 1 W switch 2 module | 606 | 10/100 |
| 6731 13 | 20 A DP 1 W switch with indicator - 2 module | 642 | 10/100 |
| 6731 14 | 20 A 2 W switch 2 module | 662 | 10/100 |

Switches – 25 A - 230 VA

| | | | |
|---------|--|-----|--------|
| 6731 15 | 25 A SP 1 W switch with indicator - 1 module | 444 | 20/200 |
|---------|--|-----|--------|



6731 01



6731 02



6731 05



6731 10



6731 12



6731 15

Myrius™ mechanisms - black

| Cat.Nos | Description | MRP* ₹ / Unit | Pack |
|---------|-------------|------------------|------|
|---------|-------------|------------------|------|

Switches – 32 A - 230 VA

| | | | |
|---------|--|-----|--------|
| 6731 16 | 32 A DP switch with indicator - 2 module | 990 | 10/100 |
|---------|--|-----|--------|

Push buttons

| | | | |
|---------|--|-----|--------|
| 6731 18 | 6 A push button SP 1 module | 256 | 20/200 |
| 6731 19 | 6 A push button SP with indicator - 1 module | 322 | 20/200 |
| 6731 20 | 6 A bell push - 1 module | 242 | 20/200 |
| 6731 21 | 6 A bell push with indicator - 1 module | 322 | 20/200 |
| 6731 22 | 6 A bell push 2 module | 372 | 10/100 |
| 6731 23 | 6 A bell push with indicator - 2 module | 444 | 10/100 |

Accessories for switches with indicator

| | | | |
|---------|----------------------------------|----|------|
| 6732 44 | Lamp for switches / push buttons | 48 | 5/50 |
|---------|----------------------------------|----|------|

Socket - black

| | | | |
|---------|--|------|--------|
| 6731 41 | 6/16 A 2 pin Euro US socket - 1 module | 346 | 20/200 |
| 6731 42 | 16 A 3 pin switched socket - 3 module | 1118 | 5/50 |
| 6731 43 | Multistandard socket for 250 V AC 15 A for 127 V type - 2 pin 2 module | 382 | 10/100 |
| 6731 44 | 6 A 5 Pin with universal socket 2 module | 310 | 20/200 |
| 6731 83 | 6/16 A socket 3 module | 526 | 5/50 |
| 6731 45 | 6/16 A socket 2 module | 446 | 10/100 |
| 6731 46 | 6/16 A - Euro socket 2 module | 502 | 10/100 |
| 6731 47 | 25 A socket - 2 module | 546 | 10/100 |

Socket - red

| | | | |
|---------|-------------------------------|-----|------|
| 6730 48 | 16 A switched socket 3 module | 992 | 5/50 |
|---------|-------------------------------|-----|------|

Dimmers & regulators

| | | | |
|---------|--|------|----------|
| 6731 24 | Rotary dimmer 400 W 1 module | 1082 | 1/5/50 |
| 6731 25 | Rotary dimmer 650 W 3 module | 2288 | 1/10 |
| 6731 26 | Compact Fluo - 2 module lamp dimmer (Universal load) | 3020 | 1/10 |
| 6731 27 | Fan step regulator 100 W 1 module | 846 | 1/5/50 |
| 6731 29 | Fan step regulator 100 W 2 module | 958 | 1/10/100 |



6731 21



6731 22



6731 41



6731 42



6731 44



6730 48



6731 25



6731 27

* MRP - Maximum Retail Price Inclusive of all taxes including GST.

Bold Cat.Nos are products normally available with Legrand (India) Stockists. Cat.Nos that are not bold - delivery within 4 - 8 weeks from the date of order. Bold packing quantity is our mandatory packing. Orders to be placed by Legrand (India) Stockist in multiples of the same.

Myrius™ mechanisms - black

| Cat.Nos | Description | MRP* ₹ / Unit | Pack |
|---------|-------------|------------------|------|
|---------|-------------|------------------|------|

Dimmers & regulators

| | | | |
|---------|--|------|----------|
| 6731 28 | Fan step regulator 120 W 2 module | 1054 | 1/10/100 |
| 6731 77 | Fan step regulator - 2 module for energy saving fans | 1018 | 1/10/100 |

Skirting light

| | | | |
|---------|--|-----|--------|
| 6731 36 | Skirting light with white LED - 3 module | 822 | 1/5/25 |
|---------|--|-----|--------|

Bell indicator

| | | | |
|---------|------------------------------------|------|--------|
| 6731 33 | Bell Indicator- 240 VA 1 module | 1206 | 20/200 |
|---------|------------------------------------|------|--------|

Buzzer

| | | | |
|---------|--|------|--------|
| 6731 34 | Buzzer - 230 VA sound level 72dB at 1 meter distance 1 module | 1170 | 20/200 |
|---------|--|------|--------|

Remote unit

| | | | |
|---------|-----------------------------------|------|--------|
| 6731 73 | Remote control switch 4 module | 8444 | 1/5/20 |
|---------|-----------------------------------|------|--------|

Hospitality functions

Key FOB switch

| | | | |
|---------|---|------|----------|
| 6731 37 | 15 A key card switch with timedelay 30 sec. monobloc with plate - 2 M | 3920 | 1/10 |
| 6732 67 | 15 A key card switch monobloc with new plate - 2 M Black | 4312 | 1/10 |
| 6730 38 | Only key fob for switch Cat.No 6731 37 & 6732 67 | 164 | 1/10/100 |

"Do Not Distrub" and MMR control unit

| | | | |
|---------|----------------------------|------|--------|
| 6731 39 | External unit - 1+1 module | 1668 | 10/100 |
| 6731 40 | Internal unit - 1+1 module | 1114 | 10/100 |

Shaver socket

| | | | |
|---------|--|------|--------|
| 6731 49 | Shaver socket 220/240 V - 50/60 Hz monobloc with plate - 4 M | 4704 | 1/5/20 |
| 6731 79 | Shaver socket 230 V / 120 - 230 V monobloc with new plate - 4 M Black | 4952 | 1/5 |

TV socket

| | | | |
|---------|--|------|--------|
| 6731 50 | TV socket - 1 module | 230 | 20/200 |
| 6731 51 | TV / Sat / FM shielded sockets 0 - 2400 MHz - 2 module | 1900 | 10/100 |

* MRP - Maximum Retail Price Inclusive of all taxes including GST.
* To be Introduced Shortly

Myrius™ mechanisms - black

| Cat.Nos | Description | MRP* ₹ / Unit | Pack |
|---------|-------------|------------------|------|
|---------|-------------|------------------|------|

Data & voice

| | | | |
|---------|--|-----|--------|
| 6731 52 | RJ-11 telephone socket with transparent shutter 1 module | 220 | 20/200 |
| 6731 53 | RJ-11 double telephone socket with shutter 1 module | 336 | 20/200 |

Data & voice

| | | | |
|---------|--|-----|--------|
| 6731 54 | UTP cat 5e RJ 45 information outlets 1 module | 484 | 20/200 |
| 6731 55 | UTP cat 6 - 1 module | 740 | 20/200 |
| 6731 56 | UTP cat 6 - 2 module | 748 | 10/100 |

USB chargers (IS13252 (Part 1) / IEC 60950-1)

| | | | |
|----------|---------------------------------|------|----------|
| 6731 80 | USB Charger 1M 1000mA | 1326 | 10/100 |
| 6731 72* | USB Charger 1M 1500mA | 1524 | 10/100 |
| 6732 78 | Double USB Charger 2M 2400mA | 2134 | 1/10/100 |

Connectors and controllers

Audio & video connector

| | | | |
|---------|--------------------------------|------|--------|
| 6731 57 | 3 x female RCA -1 module | 2930 | 1/10 |
| 6731 58 | 3 pole XLR sockets 2 module | 2766 | 10/100 |
| 6731 59 | Female HD 15 - 2 module | 3476 | 1/10 |

Sound

| | | | |
|---------|---|------|----------|
| 6731 63 | Suitable for 8 Ohms, 8 Ohms, 3 Watts (RNS) speaker - 2 module | 1408 | 1/10/100 |
|---------|---|------|----------|

Protectors and accessories

Motor starter

| | | | |
|---------|------------------------------|-----|----------|
| 6731 30 | 16 A motor starter- 2 module | 698 | 1/10/100 |
| 6731 31 | 25 A motor starter- 2 module | 714 | 1/10/100 |

Modular MCB (IS : 60898-1:2002)

| | | | |
|---------|-----------------------|-----|----------|
| 6731 64 | 16A MCB SP 1M C curve | 422 | 1/10/100 |
| 6731 65 | 20A MCB SP 1M C curve | 422 | 1/10/100 |

VSP

| | | | |
|---------|---|------|--------|
| 6731 70 | Surge filter (VSP) - 230 VA - 1 module | 2866 | 20/200 |
|---------|---|------|--------|

Accessories

| | | | |
|---------|--------------------------------|-----|--------|
| 6731 60 | Cable outlet - 8mm 1 module | 276 | 20/200 |
| 6731 61 | Blanking plate-1 module | 46 | 20/200 |

Plastic plates

White plates with frame

| | | | |
|---------|------------------------|-----|--------|
| 6732 01 | 1 Module plate + Frame | 142 | 20/200 |
| 6732 02 | 2 Module plate + Frame | 150 | 20/200 |

Bold Cat.Nos are products normally available with Legrand (India) Stockists.
Cat.Nos that are not bold - delivery within 4 - 8 weeks from the date of order.
Bold packing quantity is our mandatory packing. Orders to be placed by
Legrand (India) Stockist in multiples of the same.



6731 36



6731 33



6731 34



6731 34



6731 33



6731 37



6731 40

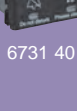

6731 40



6731 50



6731 51

6731 51



6731 52

NEW!



6731 59



6731 63



6731 63



6731 63



6731 70



6731 70

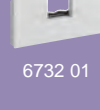

6732 01

Myrius™ plastic plates

| Cat.Nos | Description | MRP* ₹ / Unit | Pack |
|---------|-------------|---------------------|------|
|---------|-------------|---------------------|------|

White plates with frame

| | | | |
|---------|--|-----|--------|
| 6732 03 | 3 Module plate + Frame | 160 | 10/100 |
| 6732 04 | 4 Module plate + Frame | 176 | 10/100 |
| 6732 06 | 6 Module plate + Frame | 312 | 5/50 |
| 6732 08 | 8 Module plate + Frame (horizontal) | 340 | 5/50 |
| 6732 09 | 8 Module plate + Frame (4x2) | 428 | 5/25 |
| 6732 12 | 12 Module plate + Frame | 516 | 1/10 |
| 6732 16 | 16 Module plate + Frame | 600 | 1/10 |
| 6732 18 | 18 Module plate + Frame | 690 | 1/10 |

New white plates with frame#

| | | | |
|---------|--|-----|--------|
| 6732 11 | 1 Module plate + Frame | 160 | 20/200 |
| 6732 42 | 2 Module plate + Frame | 170 | 20/200 |
| 6732 13 | 3 Module plate + Frame | 186 | 10/100 |
| 6732 14 | 4 Module plate + Frame | 198 | 10/100 |
| 6732 66 | 6 Module plate + Frame | 366 | 5/50 |
| 6732 68 | 8 Module plate + Frame (Horizontal) | 390 | 5/50 |
| 6732 69 | 8 Module plate + Frame (4x2) | 488 | 5/25 |
| 6732 62 | 12 Module plate + Frame | 592 | 1/10 |
| 6732 56 | 16 Module plate + Frame | 694 | 1/10 |
| 6732 58 | 18 Module plate + Frame | 794 | 1/10 |

Black plates with frame

| | | | |
|---------|--|------|--------|
| 6732 21 | 1 Module plate + Frame | 240 | 20/200 |
| 6732 22 | 2 Module plate + Frame | 260 | 20/200 |
| 6732 23 | 3 Module plate + Frame | 274 | 10/100 |
| 6732 24 | 4 Module plate + Frame | 308 | 10/100 |
| 6732 26 | 6 Module plate + Frame | 532 | 5/50 |
| 6732 28 | 8 Module plate + Frame (Horizontal) | 590 | 5/50 |
| 6732 29 | 8 Module plate + Frame (4 x 2) | 728 | 5/25 |
| 6732 32 | 12 Module plate + Frame | 872 | 1/10 |
| 6732 36 | 16 Module plate + Frame | 1026 | 1/10 |
| 6732 38 | 18 Module plate + Frame | 1160 | 1/10 |

New black plates with frame#

| | | | |
|---------|--|------|--------|
| 6732 31 | 1 Module plate + Frame | 272 | 20/200 |
| 6732 82 | 2 Module plate + Frame | 302 | 20/200 |
| 6732 33 | 3 Module plate + Frame | 320 | 10/100 |
| 6732 34 | 4 Module plate + Frame | 352 | 10/100 |
| 6732 86 | 6 Module plate + Frame | 616 | 5/50 |
| 6732 88 | 8 Module plate + Frame (Horizontal) | 672 | 5/50 |
| 6732 89 | 8 Module plate + Frame (4 x 2) | 842 | 5/25 |
| 6732 92 | 12 Module plate + Frame | 1010 | 1/10 |
| 6732 96 | 16 Module plate + Frame | 1178 | 1/10 |
| 6732 98 | 18 Module plate + Frame | 1330 | 1/10 |

* MRP - Maximum Retail Price Inclusive of all taxes including GST.
The new plate range will be introduced shortly.

| Cat.Nos | Description | MRP* ₹ / Unit | Pack |
|---------|-------------|---------------------|------|
|---------|-------------|---------------------|------|

Mounting boxes

Flush mounting boxes

| | | | |
|---------|--|-----|----|
| 6890 07 | Flush box - 1/2 module | 102 | 40 |
| 6890 08 | Flush box - 3 module | 102 | 40 |
| 6890 09 | Flush box - 4 module | 138 | 40 |
| 6890 10 | Flush box - 6 module | 218 | 40 |
| 6890 42 | Flush box - 8 module | 256 | 40 |
| 6890 31 | Flush box - 8 module (2 row x 4) | 254 | 20 |
| 6890 11 | Flush box - 12/16 (2 row x 6) module (metal box) | 384 | 10 |
| 6890 12 | Flush box - 18 module (metal box) | 484 | 10 |

Surface mounting boxes

| | | | |
|---------|---------------------------------------|-----|-------|
| 6733 02 | Surface box - 1/2 module | 70 | 10/50 |
| 6733 03 | Surface box - 3 module | 84 | 5/35 |
| 6733 04 | Surface box - 4 module | 96 | 5/25 |
| 6733 06 | Surface box - 6 module | 124 | 1/10 |
| 6733 08 | Surface box - 8 module | 184 | 1/5 |
| 6733 05 | Surface box - 8 (2 row x 4) module | 178 | 1/5 |

Metal surface boxes

| | | | |
|---------|---|-----|-----|
| 6890 21 | Metal surface box - 12/16 (2 row x 6) module | 440 | 1/6 |
| 6890 22 | Metal surface box - 18 module | 466 | 1/4 |

Myrius™

More is on.

Guarantee

- The Company, at its discretion, will replace products if they have any manufacturing defect within 10 years for switches (without LED lamp) and power sockets. For all other **Myrius™** wiring accessories the guarantee will be 2 years.
- The above guarantee is applicable when the devices are used in Legrand metal flush boxes. Otherwise the guarantee period will be reduced by 50%.
- The guarantee is only applicable when the products are installed as per the Company's instructions and not tampered in any manner.
- The guarantee states the Company's entire liability. It does not extend to cover consequential loss or damage or installation costs arising from defective products.

* MRP - Maximum Retail Price Inclusive of all taxes including GST.
The new plate range will be introduced shortly.

MYLINC™

A LITTLE TOUCH OF GENIUS

Mylic™ is a complete range of modular wiring accessories. Switches and sockets designed and made in India, keeping everyone's requirements in mind. Whether it's safety, reliability, convenience or beauty; Mylic™ is the smart option in modular switch design.



USB Charger



8 Step Fan Regulator



Remote control unit for Light and Fan



Modular MCB



Champagne



Silver Alu



Dark Bronze



Matt Grey



Pearl White



Motor Starter



Skirting Light 2 M



Switch 25 A with indicator



MYLINC™

A LITTLE TOUCH OF GENIUS



Screwless finish & rounded corners that add beauty to any home



Linc-Loc™ intelligent design prevents wrong fitting, misaligned switches and sockets



Laser marking safeguards against fakes



Safety feature for mishap-proof use



Indicators for correct orientation



Front Removal



Stripping Template



ISI marking



CE marking

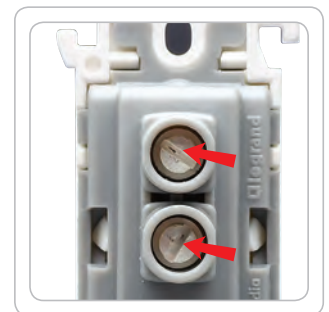

Finger-proof terminals for IP 20 protection against accidental contact

1 lac operations

with a guarantee of 100,000 operations, assuming an average switch is operated 10 times a day, this product is dependable for 27 years.

Mylic™ mechanisms

| Cat.Nos | Description | MRP* ₹ / Unit | Pack |
|---------|-------------|------------------|------|
|---------|-------------|------------------|------|

Switches and accessories

Switches 6 A - 250 V AC

| | | | |
|---------|--|-----|--------|
| 6755 01 | 6 A one-way SP switch - 1 module | 88 | 20/200 |
| 6755 02 | 6 A two-way SP switch - 1 module | 152 | 20/200 |
| 6755 03 | 6 A one-way SP switch with indicator - 1 module | 174 | 20/200 |

Switches 16 A - 250 V AC

| | | | |
|---------|---|-----|--------|
| 6755 11 | 16 A one-way SP switch - 1 module | 168 | 20/200 |
| 6755 12 | 16 A two-way SP switch - 1 module | 210 | 20/200 |
| 6755 13 | 16 A one-way SP switch with indicator - 1 module | 218 | 20/200 |

Switch 25 A - 250 V AC

| | | | |
|---------|--|-----|--------|
| 6759 68 | Switch 25 A with indicator - 1 module | 262 | 10/100 |
|---------|--|-----|--------|

Switches 32 A - 250 V AC

| | | | |
|---------|--|-----|--------|
| 6755 26 | 32 A one-way double pole switch with indicator - 2 module | 504 | 10/100 |
|---------|--|-----|--------|

Push buttons 6 A - 250 V AC

| | | | |
|---------|---|-----|--------|
| 6755 04 | 6 A one-way SP bell push - 1 module | 158 | 20/200 |
| 6755 06 | 6 A one-way SP bell push with indicator - 2 module | 314 | 10/100 |

Bell call indicator & register - 6 A - 250 V AC

| | | | |
|---------|--|-----|--------|
| 6755 07 | Bell call Indicator with register - 6 A - one-way - SP - 1 module | 840 | 20/200 |
|---------|--|-----|--------|

Lighting modules

| | | | |
|---------|---|-----|--------|
| 6755 95 | Indicator light red - 1 module | 194 | 20/200 |
| 6755 96 | Indicator light orange - 1 module | 194 | 20/200 |
| 6755 97 | Skirting light with white LED - 3 module | 628 | 1/5/25 |
| 6759 76 | Skirting light with white LED - 2 module | 424 | 5/50 |

Dimmers and fan regulators

| | | | |
|---------|---|-----|----------|
| 6755 35 | Rotative dimmer 60 - 250 W for light - 2 module | 526 | 1/10/100 |
| 6755 33 | Mylic™ dimmer 400 W for light - 1 module | 672 | 1/5/50 |
| 6759 64 | Fan regulator 100 W with 360° rotation - 2 module | 596 | 10/100 |
| 6755 30 | Fan regulator 100 W, Humfree, 0-4 steps - 2 module | 642 | 1/10/100 |
| 6755 31 | Fan regulator 100 W, Humfree, 0-4 steps - 1 module | 482 | 1/5/50 |
| 6759 77 | Fan regulator 8 steps - 2 module | 642 | 1/10/100 |

Mylic™ mechanisms

| Cat.Nos | Description | MRP* ₹ / Unit | Pack |
|---------|-------------|------------------|------|
|---------|-------------|------------------|------|

Buzzer

| | | | |
|---------|---------------|-----|--------|
| 6755 40 | Mylic™ buzzer | 564 | 20/200 |
|---------|---------------|-----|--------|

Remote unit

| | | | |
|---------|---|------|--------|
| 6759 75 | Remote control unit with remote for 4 switch & fan load 4 m | 3078 | 1/5/20 |
|---------|---|------|--------|

DND & MMR

Indicator lamp

| | | | |
|---------|---|-----|--------|
| 6755 56 | DND & MMR external unit with bellpush 3 m | 296 | 10/50 |
| 6759 69 | DND & MMR external unit with bellpush 1+1 - 2 m | 296 | 10/100 |
| 6755 57 | Mylic™ internal control unit for DND & MMR | 246 | 10/100 |

Hotel key fob switch

| | | | |
|---------|---------------------------------|------|------|
| 6755 60 | Hotel key fob switch - monobloc | 2726 | 1/10 |
| 6730 38 | Only key fob for 6755 60 | 164 | 1/10 |

Energy sockets / power unit

Energy sockets

| | | | |
|---------|--|-----|--------|
| 6755 50 | 6 A - 2/3 pin combine - 2 module | 178 | 10/100 |
| 6755 55 | 6/16 A - 3 pin combine - 2 module | 292 | 10/100 |
| 6755 51 | 6 A - 3 pin - 2 module | 196 | 10/100 |
| 6755 52 | Universal socket 6 A - 2/3 pin combine - 2 module | 222 | 10/100 |
| 6755 53 | Euro US socket 6/16 A - 2 pin, 1 module | 278 | 20/200 |
| 6755 54 | 6/10/13 A - multistandard socket - 2 Module | 294 | 10/100 |

Power unit

| | | | |
|---------|--|------|------|
| 6755 58 | Power unit for 2 ton A.C and 3.5 KW geyser - 4 module | 1032 | 5/25 |
|---------|--|------|------|

Motor starter

| | | | |
|---------|------------------------|-----|----------|
| 6759 65 | Motor starter 16 A 2 m | 482 | 1/10/100 |
|---------|------------------------|-----|----------|

Modular MCB (IS : 60898-1:2002)

| | | | |
|---------|-------------------------|-----|----------|
| 6759 74 | Modular SP MCB 16 A 1 m | 352 | 1/10/100 |
| 6756 40 | Modular SP MCB 20 A 1 m | 352 | 1/10/100 |
| 6757 41 | Modular SP MCB 25 A 1 m | 352 | 1/10/100 |
| 6758 42 | Modular SP MCB 32 A 1 m | 352 | 1/10/100 |

Low voltage sockets / TV socket and RJ11 telephone socket / accessories

| | | | |
|---------|---|-----|--------|
| 6755 46 | TV socket 1 module | 158 | 20/200 |
| 6755 41 | RJ 11 telephone socket 1 module | 148 | 20/200 |
| 6755 44 | Double RJ 11 telephone socket 1 module | 248 | 20/200 |
| 6759 66 | RJ45 socket cat 5e with shutter - 1 module | 402 | 20/200 |
| 6759 67 | RJ45 socket cat 6 with shutter - 1 module | 560 | 20/200 |

Bold Cat.Nos are products normally available with Legrand (India) Stockists. Cat.Nos that are not bold - delivery within 4 - 8 weeks from the date of order. Bold packing quantity is our mandatory packing. Orders to be placed by Legrand (India) Stockist in multiples of the same.

* MRP - Maximum Retail Price Inclusive of all taxes including GST.

Mylic™ mechanisms

| Cat.Nos | Description | MRP* ₹ / Unit | Pack |
|---------|-------------|------------------|------|
|---------|-------------|------------------|------|

USB chargers (IS13252(Part 1) / IEC 60950-1)

| | | | |
|-----------------|---|------|--------|
| 6759 71 | USB charger - 1 module | 862 | 10/100 |
| 6758 20* | USB charger 1M 1500MA | 990 | 10/100 |
| 6759 72 | Double USB charger - 2 module | 1420 | 10/100 |

Accessories

| | | | |
|----------------|--|-----|---------------|
| 6755 91 | Cable outlet - 1 module | 136 | 20/200 |
| 6755 90 | Blanking plate 0.8 mm - 1 module | 34 | 20/200 |
| 6755 92 | Spare 12 screws with nuts | 52 | 20/200 |

Mylic™ plates

Modular white plates with frame

| | | | |
|----------------|------------------------------|-----|---------------|
| 6755 61 | 1 module plate - white | 98 | 20/200 |
| 6755 62 | 2 modules plate - white | 98 | 20/200 |
| 6755 63 | 3 modules plate - white | 130 | 10/100 |
| 6755 64 | 4 modules plate - white | 148 | 10/100 |
| 6755 66 | 6 modules plate - white | 186 | 5/50 |
| 6755 67 | 8 modules horizontal - white | 238 | 5/50 |
| 6755 68 | 4x2 modules plate - white | 244 | 5/25 |
| 6755 69 | 9 modules plate- white | 282 | 5/50 |
| 6755 72 | 12 modules plate - white | 346 | 10 |
| 6755 73 | 16 modules plate - white | 400 | 10 |
| 6755 78 | 18 modules plate - white | 536 | 10 |

Mylic™ mechanism matt grey

Switches and accessories

Switches 6 A - 250 V AC

| | | | |
|---------|--|-----|---------------|
| 6763 01 | 6 A one-way SP switch - 1 module | 104 | 20/200 |
| 6763 02 | 6 A two-way SP switch - 1 module | 166 | 20/200 |
| 6763 03 | 6 A one-way SP switch with indicator - 1 module | 194 | 20/200 |

Switches 16 A - 250 V AC

| | | | |
|---------|---|-----|---------------|
| 6763 11 | 16 A one-way SP switch 1 module | 186 | 20/200 |
| 6763 12 | 16 A two-way SP switch 1 module | 230 | 20/200 |
| 6763 13 | 16 A one-way SP switch with indicator 1 module | 246 | 20/200 |

Switch 25 A - 250V AC

| | | | |
|---------|---|-----|---------------|
| 6763 41 | Switch 25 A with indicator - 1 module | 290 | 10/100 |
|---------|---|-----|---------------|

Switches 32 A - 250V AC

| | | | |
|---------|--|-----|---------------|
| 6763 26 | 32 A one-way double pole switch with indicator - 2 module | 560 | 20/200 |
|---------|--|-----|---------------|

Push buttons 6 A - 250 V AC

| | | | |
|---------|---|-----|---------------|
| 6763 04 | 6 A one-way SP bell push 1 module | 168 | 20/200 |
| 6763 06 | 6 A one-way SP bell push with indicator 2 module | 346 | 10/100 |

* MRP - Maximum Retail Price Inclusive of all taxes including GST.
* To be Introduced Shortly

Mylic™ mechanism matt grey

| Cat.Nos | Description | MRP* ₹ / Unit | Pack |
|---------|-------------|------------------|------|
|---------|-------------|------------------|------|

Bell call indicator & register - 6 A - 250 V AC

| | | | |
|---------|---|-----|---------------|
| 6763 07 | Bell call indicator with register - 6 A - one way 1 module | 926 | 20/200 |
|---------|---|-----|---------------|

Lighting modules

| | | | |
|---------|--|-----|---------------|
| 6763 14 | Indicator light red 1 module | 210 | 20/200 |
| 6763 15 | Indicator light orange 1 module | 210 | 20/200 |
| 6763 16 | Skirting light with white LED - 3 module | 690 | 1/5/25 |
| 6763 10 | Skirting light with white LED - 2 module | 468 | 5/50 |

Dimmers and fan regulators

| | | | |
|---------|---|-----|----------|
| 6763 17 | Rotative dimmer 60 - 250 W for light 2 module | 580 | 1/10/100 |
| 6763 18 | Rotative dimmer 60 - 400 W 1 module | 740 | 1/5/50 |
| 6763 37 | Fan regulator 100 W, with 360° rotation 2 module | 656 | 10/100 |
| 6763 19 | Fan regulator 4 step 2 module | 706 | 1/10/100 |
| 6763 20 | Fan regulator 4 step 1 module | 526 | 1/5/50 |
| 6763 08 | Fan regulator 8 step 2 module | 702 | 1/10/100 |

Buzzer

| | | | |
|---------|--------------|-----|---------------|
| 6763 21 | Mylic buzzer | 616 | 20/200 |
|---------|--------------|-----|---------------|

Remote unit

| | | | |
|---------|---|------|--------|
| 6763 47 | Remote control unit with remote for 4 switch & fan load 4 m | 3388 | 1/5/20 |
|---------|---|------|--------|

DND & MMR

Indicator lamp

| | | | |
|---------|--|-----|---------------|
| 6763 42 | DND & MMR external unit with bellpush 1+1 | 328 | 10/100 |
| 6763 23 | Mylic internal control unit for DND & MMR | 272 | 10/100 |

Hotel key fob switch

| | | | |
|---------|----------------------------------|------|------|
| 6730 38 | Only key fob for 6755 60 | 164 | 1/10 |
| 6763 24 | Hotel key fob switch monobloc | 2996 | 1/10 |

Energy sockets / power unit

Energy sockets

| | | | |
|---------|--|-----|---------------|
| 6763 25 | 6 A - 2/3 pin combined | 200 | 10/100 |
| 6763 05 | 6/16A - 3 pin Combined 2 module | 316 | 10/100 |
| 6763 27 | 6 A - 3 pin - 2 module | 212 | 10/100 |
| 6763 28 | Universal socket 6A-2/3 pin combined 2 module | 246 | 10/100 |

Bold Cat.Nos are products normally available with Legrand (India) Stockists.
Cat.Nos that are not bold - delivery within 4 - 8 weeks from the date of order.
Bold packing quantity is our mandatory packing. Orders to be placed by
Legrand (India) Stockist in multiples of the same.

Mylic™ mechanism matt grey

| Cat.Nos | Description | MRP* ₹ / Unit | Pack |
|---------|-------------|------------------|------|
|---------|-------------|------------------|------|

Energy sockets / power unit

Energy sockets

| | | | |
|---------|--|-----|---------------|
| 6763 29 | Euro US socket 6/16A - 2 pin 1 module | 308 | 20/200 |
| 6763 30 | 6/10/13 A - Multistandard socket 2 module | 320 | 10/100 |

Power unit

| | | | |
|---------|--|------|------|
| 6763 31 | Power unit for 2 ton A.C and 3.5 KW geyser - 4 module | 1168 | 5/25 |
|---------|--|------|------|

Motor starter

| | | | |
|---------|------------------------|-----|----------|
| 6763 38 | Motor starter 16 A 2 m | 532 | 1/10/100 |
|---------|------------------------|-----|----------|

Modular MCB (IS : 60898-1:2002)

| | | | |
|---------|----------------------------|-----|----------|
| 6763 46 | Modular SP MCB 16 A 1 m | 392 | 1/10/100 |
|---------|----------------------------|-----|----------|

Low voltage sockets / TV socket and RJ11 telephone socket / accessories

Sockets

| | | | |
|---------|---|-----|---------------|
| 6763 32 | TV socket - 1 module | 168 | 20/200 |
| 6763 33 | RJ 11 telephone 1 module | 162 | 20/200 |
| 6763 34 | Double RJ 11 telephone socket 1 module | 268 | 20/200 |
| 6763 39 | RJ 45 socket cat 5e with shutter 1 module | 438 | 20/200 |
| 6763 40 | RJ 45 socket cat 6 with shutter 1 module | 612 | 20/200 |

USB chargers (IS13252(Part 1) / IEC 60950-1)

| | | | |
|-----------------|---------------------------------------|------|---------------|
| 6763 43 | USB charger 1 module | 946 | 10/100 |
| 6758 21* | USB charger 1M 1500MA | 1086 | 10/100 |
| 6763 44 | Double USB charger 2 module | 1564 | 1/10/100 |

Accessories

| | | | |
|---------|--|-----|---------------|
| 6763 48 | Cable outlet 1 module | 154 | 20/200 |
| 6763 49 | Blanking plate 0.8 mm 1 module | 36 | 20/200 |

Mylic™ plates

Modular Matt Grey plates with frame

| | | | |
|---------|-----------------------------------|-----|---------------|
| 6763 50 | Matt grey plate 1 m | 128 | 20/200 |
| 6763 51 | Matt grey plate 2 m | 128 | 20/200 |
| 6763 52 | Matt grey plate 3 m | 176 | 10/100 |
| 6763 53 | Matt grey plate 4 m | 188 | 10/100 |
| 6763 54 | Matt grey plate 6 m | 238 | 5/50 |
| 6763 55 | Matt grey plate 8 m horizontal | 312 | 5/50 |
| 6763 56 | Matt grey plate 4x2 m | 312 | 5/25 |
| 6763 57 | Matt grey 9 m | 364 | 5/50 |
| 6763 58 | Matt grey plate 12 m | 446 | 10 |
| 6763 59 | Matt grey plate 18 m | 704 | 10 |

Modular colour plates with frame

| Cat.Nos | Description | MRP* ₹ / Unit | Pack |
|---------|-------------|------------------|------|
|---------|-------------|------------------|------|

Pearl white cover plates

| | | | |
|---------|-------------------------------------|-----|---------------|
| 6763 60 | Pearl white plate 1 m | 118 | 10/100 |
| 6763 61 | Pearl white plate 2 m | 118 | 10/100 |
| 6763 62 | Pearl white plate 3 m | 160 | 10/100 |
| 6763 63 | Pearl white plate 4 m | 170 | 10/100 |
| 6763 64 | Pearl white plate 6 m | 224 | 5/50 |
| 6763 65 | Pearl white 8 m plate horizontal | 284 | 5/50 |
| 6763 66 | Pearl white plate 4x2 m | 288 | 5/25 |
| 6763 67 | Pearl white plate 9 m | 336 | 5/50 |
| 6763 68 | Pearl white plate 12 m | 412 | 5/25 |
| 6763 69 | Pearl white plate 18 m | 646 | 5/25 |

Champagne cover plates

| | | | |
|---------|-----------------------------------|-----|---------------|
| 6763 70 | Champagne plate 1 m | 118 | 10/100 |
| 6763 71 | Champagne plate 2 m | 118 | 10/100 |
| 6763 72 | Champagne plate 3 m | 160 | 10/100 |
| 6763 73 | Champagne plate 4 m | 170 | 10/100 |
| 6763 74 | Champagne plate 6 m | 224 | 5/50 |
| 6763 75 | Champagne plate 8 m horizontal | 284 | 5/50 |
| 6763 76 | Champagne plate 4x2 m | 288 | 5/25 |
| 6763 77 | Champagne plate 9 m | 336 | 5/50 |
| 6763 78 | Champagne plate 12 m | 412 | 5/25 |
| 6763 79 | Champagne plate 18 m | 646 | 5/25 |

Silver alu cover plates

| | | | |
|---------|------------------------------------|-----|---------------|
| 6763 80 | Silver alu plate 1 m | 118 | 10/100 |
| 6763 81 | Silver alu plate 2 m | 118 | 10/100 |
| 6763 82 | Silver alu plate 3 m | 160 | 10/100 |
| 6763 83 | Silver alu plate 4 m | 170 | 10/100 |
| 6763 84 | Silver alu plate 6 m | 224 | 5/50 |
| 6763 85 | Silver alu plate 8 m horizontal | 284 | 5/50 |
| 6763 86 | Silver alu plate 4x2 m | 288 | 5/25 |
| 6763 87 | Silver alu plate 9 m | 336 | 5/50 |
| 6763 88 | Silver alu plate 12 m | 412 | 5/25 |
| 6763 89 | Silver alu plate 18 m | 646 | 5/25 |

Dark bronze cover plates

| | | | |
|---------|-------------------------------------|-----|---------------|
| 6763 90 | Dark bronze plate 1 m | 118 | 10/100 |
| 6763 91 | Dark bronze plate 2 m | 118 | 10/100 |
| 6763 92 | Dark bronze plate 3 m | 160 | 10/100 |
| 6763 93 | Dark bronze plate 4 m | 170 | 10/100 |
| 6763 94 | Dark bronze plate 6 m | 224 | 5/50 |
| 6763 95 | Dark bronze plate 8 m horizontal | 284 | 5/50 |
| 6763 96 | Dark bronze plate 4x2 m | 288 | 5/25 |
| 6763 97 | Dark bronze plate 9 m | 336 | 5/50 |
| 6763 98 | Dark bronze plate 12 m | 412 | 5/25 |
| 6763 99 | Dark bronze plate 18 m | 646 | 5/25 |

* MRP - Maximum Retail Price Inclusive of all taxes including GST.

* To be Introduced Shortly

Bold Cat.Nos are products normally available with Legrand (India) Stockists. Cat.Nos that are not bold - delivery within 4 - 8 weeks from the date of order. Bold packing quantity is our mandatory packing. Orders to be placed by Legrand (India) Stockist in multiples of the same.

Mylic™ boxes

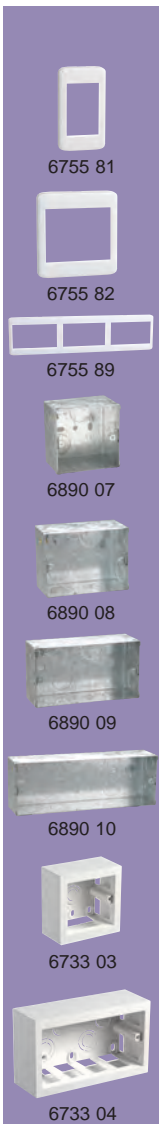

| Cat.Nos | Description | MRP* ₹ / Unit | Pack |
|---------|-------------|---------------------|------|
|---------|-------------|---------------------|------|

Modular white surrounds

| | | | |
|---------|-----------------------------|-----|--------|
| 6755 81 | 1 module | 42 | 20/200 |
| 6755 82 | 2 modules | 66 | 20/200 |
| 6755 83 | 3 modules | 66 | 10/100 |
| 6755 84 | 4 modules | 104 | 10/100 |
| 6755 86 | 6 modules (2 column x 3) | 148 | 10/100 |
| 6755 89 | 9 modules (3 column x 3) | 258 | 10/100 |

Metal flush boxes

| | | | |
|---------|----------------------------------|-----|----|
| 6890 07 | Flush box - 1/2 modules | 102 | 40 |
| 6890 08 | Flush box - 3 modules | 102 | 40 |
| 6890 09 | Flush box - 4 modules | 138 | 40 |
| 6890 10 | Flush box - 6 modules | 218 | 40 |
| 6890 42 | Flush box - 8 modules | 256 | 40 |
| 6890 31 | Flush box - 4 x 2 modules | 254 | 20 |
| 6890 29 | Flush box - 9 modules | 298 | 20 |
| 6890 11 | Flush box - 12 modules | 384 | 10 |
| 6890 13 | Flush box - 16 modules | 438 | 10 |
| 6890 12 | Flush box - 18 modules | 484 | 10 |

Plastic surface boxes

| | | | |
|---------|-----------------------------------|-----|-------|
| 6733 02 | Surface box- 1/2 modules | 70 | 10/50 |
| 6733 03 | Surface box- 3 modules | 84 | 5/35 |
| 6733 04 | Surface box- 4 modules | 96 | 5/25 |
| 6733 06 | Surface box- 6 modules | 124 | 1/10 |
| 6733 08 | Surface box- 8 modules | 184 | 1/5 |
| 6733 05 | Surface box- 4 x 2 modules | 178 | 1/5 |
| 6740 99 | Surface box- 9 modules | 210 | 1/5 |

Metal surface boxes

| | | | |
|---------|--|-----|-----|
| 6890 21 | Metal surface box- 12 modules (2 rows x 6) | 440 | 1/6 |
| 6890 22 | Metal surface box- 18 modules (3 rows x 6) | 466 | 1/4 |

MYLINC™

A LITTLE TOUCH OF GENIUS

Guarantee

- The Company, at its discretion, will replace products if they have any manufacturing defect within 10 years for switches (without LED lamp) and power sockets. For all other **Mylic™** wiring accessories the guarantee will be 2 years.
- The above guarantee is applicable when the devices are used in Legrand metal flush boxes. Otherwise the guarantee period will be reduced by 50%.
- The guarantee is only applicable when the products are installed as per the Company's instructions and not tampered in any manner.
- The guarantee states the Company's entire liability. It does not extend to cover consequential loss or damage or installation costs arising from defective products.

* MRP - Maximum Retail Price Inclusive of all taxes including GST.

LYNCUS™

TIME TO CHANGE TO TODAY

Today's homes need a range that mirrors their look. A modern sleek look with clean lines. A look that is chic and futuristic. Our new Lyncus range brings the aesthetic to your home, but with a subtle touch that adds character to every room



White



Chic Grey

LYNCUS™

TIME TO CHANGE TO TODAY

RANGE



Brushed



Alu Sunset



Champagne



Matt Silver



USB TYPE C



USB TYPE A + TYPE C



COMBI TWIN USB



REMOTE CONTROL UNIT



INDUCTION CHARGER



BLUETOOTH SOUND RECEIVER



ONE WAY TOUCH SWITCH



TOUCH FAN REGULATOR



UNIVERSAL TOUCH DIMMER

Lyncus™ mechanisms white

NEW!

| Cat.Nos | Description | MRP* ₹ / Unit | Pack |
|---------|-------------|------------------|------|
|---------|-------------|------------------|------|

Switches 6 A 230 V AC

| | | | |
|---------|--|-----|--------|
| 6772 00 | 6 A Switch 1 W 1 module | 78 | 20/200 |
| 6772 01 | 6 A Switch 2 W 1 module | 134 | 20/200 |
| 6772 02 | 6 A Switch 1 W 1 module with indicator | 134 | 20/200 |
| 6772 03 | 6 A Switch 1 W 1 module with "Light" marking | 126 | 20/200 |
| 6772 04 | 6 A Switch 1 W 1 module with "Fan" marking | 126 | 20/200 |

Switches 10 A 230 V AC

| | | | |
|---------|---|------|--------|
| 6772 05 | 10 A Switch 1 W 2 module | 166 | 10/100 |
| 6772 06 | 10 A Switch 2 W 2 module | 194 | 10/100 |
| 6772 07 | 10 A Intermediate switch 2 module | 1094 | 10/100 |
| 6772 08 | 10 A Switch 1 W with indicator 2 module | 210 | 10/100 |

Switches 16 A 230 V AC

| | | | |
|---------|---|-----|--------|
| 6772 09 | 16 A Switch 1 W 1 module | 152 | 20/200 |
| 6772 10 | 16 A Switch 2 W 1 module | 190 | 20/200 |
| 6772 11 | 16 A Switch 1 W with indicator 1 module | 196 | 20/200 |

Switches 20A 230V AC

| | | | |
|---------|--|-----|--------|
| 6772 12 | 20 A Switch 1 W 1 module | 228 | 20/200 |
| 6772 13 | 20 A DP Switch 1 W 2 module | 330 | 10/100 |
| 6772 14 | 20 A DP Switch 1 W with indicator 2 module | 340 | 10/100 |
| 6772 15 | 20 A Switch 2 way 2 module | 378 | 10/100 |

Switches 25 A 230 V AC

| | | | |
|---------|--|-----|--------|
| 6772 16 | 25 A SP 1 W Switch with indicator 1 module | 236 | 20/200 |
|---------|--|-----|--------|

Switches 32 A 230 V AC

| | | | |
|---------|--|-----|--------|
| 6772 17 | 32 A DP Switch with indicator 2 module | 456 | 10/100 |
|---------|--|-----|--------|

Push button 6 A 230 V AC

| | | | |
|---------|--|-----|--------|
| 6772 18 | 6 A Push button SP 1 module | 108 | 20/200 |
| 6772 19 | 6 A Push button SP with indicator 1 module | 158 | 20/200 |
| 6772 20 | 6 A Bell push 1 module | 140 | 20/200 |
| 6772 21 | 6 A Bell push with indicator 1 module | 172 | 20/200 |
| 6772 22 | 6 A Bell push 2 module | 190 | 10/100 |
| 6772 23 | 6 A Bell push with indicator 2 module | 282 | 10/100 |

Accessories for switches

| | | | |
|---------|----------------------------|----|------|
| 6772 24 | LED Indicator for switches | 28 | 5/50 |
|---------|----------------------------|----|------|

Socket 240 V AC

| | | | |
|---------|---|-----|--------|
| 6772 25 | 6/16 A 2 Pin Euro US socket 1 module | 244 | 20/200 |
| 6772 26 | 16 A 3 Pin Switched socket 3 module | 482 | 5/50 |
| 6772 27 | Multistandard socket 6/10/13 A 2/3 Pin for 250 VAC 15 A for 127 V type 2 Pin 2 module | 258 | 10/100 |
| 6772 28 | 6 A 2/3 Pin Universal socket 2 module | 196 | 20/200 |
| 6772 29 | 6/16 A Socket 3 module | 300 | 5/50 |
| 6772 30 | 6/16 A Socket 2 module | 252 | 10/100 |
| 6772 31 | 6/16 A Euro Socket 2 module | 262 | 10/100 |
| 6772 32 | 25 A Socket 2 module | 258 | 10/100 |

* MRP - Maximum Retail Price Inclusive of all taxes including GST.
Red Cat.Nos - new products

Lyncus™ mechanisms white

NEW!

| Cat.Nos | Description | MRP* ₹ / Unit | Pack |
|---------|-------------|------------------|------|
|---------|-------------|------------------|------|

Dimmers and fan regulators

| | | | |
|---------|---|-----|----------|
| 6772 36 | Rotary light dimmer 400 W 1 module | 460 | 5/50 |
| 6772 37 | Rotary light dimmer 500 W 2 module | 584 | 10/100 |
| 6772 39 | Fan regulator 100 W 1 module | 420 | 5/50 |
| 6772 40 | Fan regulator 100 W 360 degree 2 module | 518 | 10/100 |
| 6772 41 | Fan regulator 120 W 360 degree 2 module | 590 | 10/100 |
| 6772 42 | Fan step regulator 70 W 2 module | 568 | 1/10/100 |

Emergency light

| | | | |
|---------|-----------------------------|------|------|
| 6772 43 | Removable LED lamp 2 module | 2000 | 1/12 |
|---------|-----------------------------|------|------|

Skirting light

| | | | |
|---------|-----------------------------|-----|------|
| 6772 48 | LED skirting light 3 module | 382 | 5/25 |
|---------|-----------------------------|-----|------|

Indicator

| | | | |
|---------|---|-----|--------|
| 6772 87 | Indicator unit 1 module with transparent led & colored labels | 424 | 10/100 |
|---------|---|-----|--------|

Bell call indicator

| | | | |
|---------|------------------------------------|-----|--------|
| 6772 49 | Bell call indicator 240 V 1 module | 756 | 20/200 |
|---------|------------------------------------|-----|--------|

Buzzer

| | | | |
|---------|-----------------------|-----|--------|
| 6772 50 | Buzzer 230 V 1 module | 506 | 20/200 |
|---------|-----------------------|-----|--------|

Infrared Sensors

| | | | |
|---------|--------------------------------|------|------|
| 6772 51 | Infrared sensor 400 W 2 module | 1360 | 1/50 |
|---------|--------------------------------|------|------|

Remote unit

| | | | |
|---------|--|------|--------|
| 6772 52 | Remote control unit for light & fan 4 module | 2770 | 1/5/20 |
| 6773 03 | Remote control hand unit | 518 | 1/5/30 |

Hospitality function

Hotel keycard switch

| | | | |
|---------|-------------------------------|------|--------|
| 6772 53 | 16 A Key card switch 2 module | 2454 | 1/10 |
| 6772 55 | Credit card size key fob | 88 | 10/100 |

Hotel "DND and MMR" functions

| | | | |
|---------|--|-----|--------|
| 6772 56 | DND & MMR indicator with bell push 1+1 module | 268 | 10/100 |
| 6772 57 | Internal control unit for DND & MMR 1+1 module | 222 | 10/100 |

Shaver socket

| | | | |
|---------|---|------|------|
| 6772 58 | Shaver socket 120/240 V MonoBlock with plate 2 module | 1868 | 1/16 |
|---------|---|------|------|

Sockets and connectors

TV sockets

| | | | |
|---------|----------------------------|-----|--------|
| 6772 60 | TV Coaxial socket 1 module | 142 | 20/200 |
|---------|----------------------------|-----|--------|

Data & voice

| | | | |
|---------|---------------------------------------|-----|--------|
| 6772 62 | Telephone socket RJ11 1 module | 132 | 20/200 |
| 6772 63 | Telephone socket double RJ11 1 module | 222 | 20/200 |

Bold Cat.Nos are products normally available with Legrand (India) Stockists. Cat.Nos that are not bold - delivery within 4 - 8 weeks from the date of order. Bold packing quantity is our mandatory packing. Orders to be placed by Legrand (India) Stockist in multiples of the same.

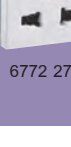
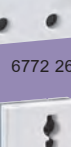
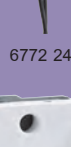

Lyncus™ sockets and connectors

NEW!



6772 63



6772 67



6772 70



6772 71



6772 74



6772 88



6772 89



6772 90



6772 92



6772 95



6772 98



6773 04

Data & voice

| Cat.Nos | Description | MRP* ₹ / Unit | Pack |
|---------|--|------------------|--------|
| 6772 64 | RJ 45 UTP cat 5 tooless with shutter 1 M white | 380 | 20/200 |
| 6772 65 | RJ 45 UTP cat 6 tooless with shutter 1 M white | 532 | 20/200 |

Audio video connectors

| Cat.Nos | Description | MRP* ₹ / Unit | Pack |
|---------|--|------------------|------|
| 6772 67 | Preterminated audio video connector 1 module | 1090 | 1/10 |
| 6772 68 | Preterminated HDMI socket 1 module | 1340 | 1/10 |
| 6772 69 | Preterminated projector connector 1 module | 1340 | 1/10 |

Sound (Volume controller)

| Cat.Nos | Description | MRP* ₹ / Unit | Pack |
|---------|----------------------------|------------------|----------|
| 6772 70 | Volume controller 2 module | 828 | 1/10/100 |

Protectors and accessories

Motor starter

| Cat.Nos | Description | MRP* ₹ / Unit | Pack |
|---------|-----------------------------|------------------|----------|
| 6772 71 | 16 A Motor starter 2 module | 482 | 1/10/100 |
| 6772 72 | 25 A Motor starter 2 module | 482 | 1/10/100 |

VSP

| Cat.Nos | Description | MRP* ₹ / Unit | Pack |
|---------|--|------------------|--------|
| 6772 74 | Voltage surge protector 230 V 1 module | 1526 | 20/200 |

Modular MCB (IS : 608981:2002)

| Cat.Nos | Description | MRP* ₹ / Unit | Pack |
|---------|-------------------------|------------------|----------|
| 6772 81 | 16 A MCB SP 1 M C curve | 318 | 1/10/100 |
| 6772 82 | 20 A MCB SP 1 M C curve | 318 | 1/10/100 |
| 6772 83 | 32 A MCB SP 1 M C curve | 318 | 1/10/100 |

Electronic function

USB chargers (IS13252 (Part 1) / IEC 60950-1)

| Cat.Nos | Description | MRP* ₹ / Unit | Pack |
|----------|---|------------------|----------|
| 6772 88 | USB Charger 1000 mA 1 module type A | 668 | 1/5/50 |
| 6772 91* | USB Charger 1500 mA 1 module type A | 768 | 1/5/50 |
| 6772 89 | Double USB charger 3000 mA 2 module type A & type C | 2002 | 1/10/100 |
| 6772 90 | USB Charger 1500 mA 1 module type C | 962 | 1/5/50 |

Combi (Socket + USB)

| Cat.Nos | Description | MRP* ₹ / Unit | Pack |
|---------|---|------------------|--------|
| 6772 92 | Combi twin USB 2400 mA multistandard socket type A | 2310 | 1/5/50 |
| 6772 94 | Combi twin USB 2400 mA multistandard socket type A & type C | 2542 | 1/5/50 |

Wireless charger**

| Cat.Nos | Description | MRP* ₹ / Unit | Pack |
|---------|---|------------------|------|
| 6772 95 | Wireless charger + type-A USB 1 A - 5 V / 5 W charger with one 2.4 A/12 W USB port to power a second device | 5704 | 1/10 |

Loud speakers

| Cat.Nos | Description | MRP* ₹ / Unit | Pack |
|----------|---|------------------|------|
| 6772 98* | Loudspeaker for false ceiling & plaster board 8 Ohms 10 W | 1814 | 1/6 |

Sound diffusion

| Cat.Nos | Description | MRP* ₹ / Unit | Pack |
|---------|------------------------------------|------------------|----------|
| 6772 99 | Bluetooth sound diffusion 2 module | 4002 | 1/10/100 |

Rotary dimmer universal

| Cat.Nos | Description | MRP* ₹ / Unit | Pack |
|---------|---------------------------------------|------------------|----------|
| 6773 04 | Rotary led light dimmer 50 W 1 module | 1868 | 1/10/120 |

* MRP - Maximum Retail Price Inclusive of all taxes including GST.
* To be Introduced Shortly
** Charging only with wireless compatible phone having induction receiver technology
Red Cat.Nos - new products

Lyncus™ electronic function

NEW!



6773 09



6773 06



6773 15



6773 16



6773 15



6773 16

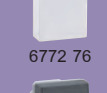

6772 75



6772 76



6772 77



6774 00



6774 01



6774 02

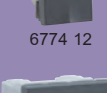

6774 03

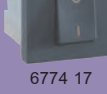

6774 04



6774 05



6774 06



6774 07

6774 08

6774 09

6774 10

6774 11

6774 12

6774 13

6774 14

6774 15

6774 16

6774 17

Touch switches

| Cat.Nos | Description | MRP* ₹ / Unit | Pack |
|---------|--------------------------------|------------------|------|
| 6773 09 | 6 A Touch switch 1 W 2 module | 2758 | 1/50 |
| 6773 10 | 6 A Touch Switch 2 W 2 Module | 3184 | 1/50 |
| 6773 13 | 16 A Touch switch 1 W 2 module | 3184 | 1/50 |
| 6773 06 | 6 A Touch bell push 2 module | 2758 | 1/50 |

Touch regulator & dimmer

| Cat.Nos | Description | MRP* ₹ / Unit | Pack |
|---------|---|------------------|------|
| 6773 05 | Touch fan regulator 100 W 2 module | 3184 | 1/50 |
| 6773 15 | 300 W Universal led touch light scroll dimming 2 module | 3184 | 1/50 |

Reading light

| Cat.Nos | Description | MRP* ₹ / Unit | Pack |
|---------|-------------------|------------------|------|
| 6773 16 | Reading light led | 1556 | 1/12 |

Accessories

| Cat.Nos | Description | MRP* ₹ / Unit | Pack |
|---------|----------------------------|------------------|--------|
| 6772 75 | Cable outlet 8 mm 1 module | 122 | 20/200 |
| 6772 76 | Blanking plate 1 module | 30 | 20/200 |
| 6772 77 | Blanking plate 2 module | 44 | 10/100 |

Lyncus™ mechanisms chic grey

Switches 6A 230V AC

| Cat.Nos | Description | MRP* ₹ / Unit | Pack |
|---------|--|------------------|--------|
| 6774 00 | 6 A Switch 1 W 1 module | 88 | 20/200 |
| 6774 01 | 6 A Switch 2 W 1 module | 154 | 20/200 |
| 6774 02 | 6 A Switch 1 W 1 module with Indicator | 158 | 20/200 |
| 6774 03 | 6 A Switch 1 W 1 module with "Light" marking | 148 | 20/200 |
| 6774 04 | 6 A Switch 1 W 1 module with "Fan" marking | 148 | 20/200 |

Switches 10A 230V AC

| Cat.Nos | Description | MRP* ₹ / Unit | Pack |
|---------|---|------------------|--------|
| 6774 05 | 10 A Switch 1 W 2 module | 190 | 10/100 |
| 6774 06 | 10 A Switch 2 W 2 module | 222 | 10/100 |
| 6774 07 | 10 A Intermediate switch 2 module | 1260 | 10/100 |
| 6774 08 | 10 A Switch 1 W with Indicator 2 module | 244 | 10/100 |

Switches 16A 230V AC

| Cat.Nos | Description | MRP* ₹ / Unit | Pack |
|---------|---|------------------|--------|
| 6774 09 | 16 A Switch 1 W 1 module | 174 | 20/200 |
| 6774 10 | 16 A Switch 2 W 1 module | 218 | 20/200 |
| 6774 11 | 16 A Switch 1 W with indicator 1 module | 228 | 20/200 |

Switches 20A 230V AC

| Cat.Nos | Description | MRP* ₹ / Unit | Pack |
|---------|--|------------------|--------|
| 6774 12 | 20 A Switch 1 W 1 module | 262 | 20/200 |
| 6774 13 | 20 A DP Switch 1 W 2 module | 382 | 10/100 |
| 6774 14 | 20 A DP Switch 1 W with indicator 2 module | 388 | 10/100 |
| 6774 15 | 20 A Switch 2 W 2 module | 436 | 10/100 |

Switches 25A 230V AC

| Cat.Nos | Description | MRP* ₹ / Unit | Pack |
|---------|---|------------------|--------|
| 6774 16 | 25A SP 1 W Switch with indicator 1 module | 272 | 20/200 |

Switches 32A 230V AC

| Cat.Nos | Description | MRP* ₹ / Unit | Pack |
|---------|---------------------------------------|------------------|--------|
| 6774 17 | 32A DP Switch with indicator 2 module | 520 | 10/100 |

Bold Cat.Nos are products normally available with Legrand (India) Stockists. Cat.Nos that are not bold - delivery within 4 - 8 weeks from the date of order. Bold packing quantity is our mandatory packing. Orders to be placed by Legrand (India) Stockist in multiples of the same.

Lyncus™ mechanisms chic grey

NEW!



6774 18



6774 22



6774 27



6774 29



6774 31



6774 37



6774 39



6774 48



6774 49



6774 50



6774 56

| Cat.Nos | Description | MRP* ₹ / Unit | Pack |
|---------|-------------|------------------|------|
|---------|-------------|------------------|------|

Push button 6 A 230 V AC

| | | | |
|---------|--|-----|--------|
| 6774 18 | 6 A Push button SP 1 module | 126 | 20/200 |
| 6774 19 | 6 A Push button SP with indicator 1 module | 180 | 20/200 |
| 6774 20 | 6 A Bell push 1 module | 162 | 20/200 |
| 6774 21 | 6 A Bell push with indicator module | 194 | 20/200 |
| 6774 22 | 6 A Bell push 2 module | 216 | 10/100 |
| 6774 23 | 6 A Bell Push with indicator 2 module | 324 | 10/100 |

Sockets 240 V AC

| | | | |
|---------|---|-----|--------|
| 6774 25 | 6/16 A 2 Pin Euro US socket 1 module | 280 | 20/200 |
| 6774 27 | Multistandard socket 6/10/13 A 2/3 Pin for 250 VAC 15 A for 127 V type 2 Pin 2 module | 294 | 10/100 |
| 6774 28 | 6 A 2/3 Pin Universal socket 2 module | 224 | 20/200 |
| 6774 29 | 6/16 A Socket 3 module | 344 | 5/50 |
| 6774 30 | 6/16 A Socket 2 module | 292 | 10/100 |
| 6774 31 | 6/16 A Euro socket 2 module | 298 | 10/100 |
| 6774 32 | 25 A Socket 2 module | 298 | 10/100 |

Dimmers and fan regulators

| | | | |
|---------|---|-----|----------|
| 6774 36 | Rotary light dimmer 400 W 1 module | 526 | 5/50 |
| 6774 37 | Rotary light dimmer 500 W 2 module | 676 | 10/100 |
| 6774 39 | Fan regulator 100 W 1 module | 484 | 5/50 |
| 6774 40 | Fan regulator 100 W 360 degree 2 module | 596 | 10/100 |
| 6774 41 | Fan regulator 120 W 360 degree 2 module | 680 | 10/100 |
| 6774 42 | Fan step regulator 70 W 2 module | 656 | 1/10/100 |

Skirting light

| | | | |
|---------|-----------------------------|-----|------|
| 6774 48 | LED skirting light 3 module | 440 | 5/25 |
|---------|-----------------------------|-----|------|

Bell call indicator

| | | | |
|---------|------------------------------------|-----|--------|
| 6774 49 | Bell call indicator 240 V 1 module | 868 | 20/200 |
|---------|------------------------------------|-----|--------|

Buzzer

| | | | |
|---------|-----------------------|-----|--------|
| 6774 50 | Buzzer 230 V 1 module | 584 | 20/200 |
|---------|-----------------------|-----|--------|

Remote unit

| | | | |
|---------|--|------|--------|
| 6774 52 | Remote control unit for light & fan 4 module | 3184 | 1/5/20 |
| 6773 03 | Remote control hand unit | 518 | 1/5/30 |

Hospitality function

Hotel keycard switch

| | | | |
|---------|---|------|------|
| 6774 53 | 16A Key card switch 2 module credit card size key fob | 2824 | 1/10 |
|---------|---|------|------|

Hotel "DND and MMR" functions

| | | | |
|---------|--|-----|--------|
| 6774 56 | DND & MMR indicator with bell push 1+1 module | 308 | 10/100 |
| 6774 57 | Internal control unit for DND & MMR 1+1 module | 254 | 10/100 |

* MRP - Maximum Retail Price Inclusive of all taxes including GST.

• To be Introduced Shortly

Red Cat.Nos - new products

Lyncus™ hospitality function

NEW!



6774 58



6774 60



6774 62



6774 64



6774 70



6774 88



6774 89



6774 24



6774 76



6775 02

| Cat.Nos | Description | MRP* ₹ / Unit | Pack |
|---------|-------------|------------------|------|
|---------|-------------|------------------|------|

Shaver socket

| | | | |
|---------|---|------|------|
| 6774 58 | Shaver socket 120/240 V MonoBlock with plate 2 module | 2148 | 1/16 |
|---------|---|------|------|

Sockets and connectors

TV sockets

| | | | |
|---------|----------------------------|-----|--------|
| 6774 60 | TV Coaxial socket 1 module | 160 | 20/200 |
|---------|----------------------------|-----|--------|

Data & voice

| | | | |
|---------|---|-----|--------|
| 6774 62 | Telephone socket RJ11 1 module | 152 | 20/200 |
| 6774 63 | Telephone socket double RJ11 1 module | 258 | 20/200 |
| 6774 64 | RJ 45 UTP cat 5 tooless with shutter 1 M grey | 418 | 20/200 |
| 6774 65 | RJ 45 UTP cat 6 tooless with shutter 1 M grey | 586 | 20/200 |

Audio video sockets

| | | | |
|---------|--|------|------|
| 6774 67 | Preterminated audio video connector 1 module | 1256 | 1/10 |
| 6774 68 | Preterminated HDMI socket 1 module | 1536 | 1/10 |
| 6774 69 | Preterminated projector connector 1 module | 1536 | 1/10 |

Sound (Volume controller)

| | | | |
|---------|----------------------------|-----|----------|
| 6774 70 | Volume controller 2 module | 952 | 1/10/100 |
|---------|----------------------------|-----|----------|

Electronic function

USB chargers (IS13252 (Part 1) / IEC 609501)

| | | | |
|----------|---|------|----------|
| 6774 88 | USB charger 1000 mA 1 module type A | 768 | 1/5/50 |
| 6774 91* | USB charger 1500 mA 1 module type A | 884 | 1/5/50 |
| 6774 89 | Double USB charger 3000 mA 2 module type A & type C | 2302 | 1/10/100 |
| 6774 90 | USB charger 1500 mA 1 module type C | 1108 | 1/5/50 |

Combi (Socket+USB)

| | | | |
|---------|--|------|--------|
| 6774 92 | Combi twin USB 2400 mA multi-standard socket type A | 2654 | 1/5/50 |
| 6774 94 | Combi twin USB 2400 mA multi-standard socket type A & type C | 2924 | 1/5/50 |

Sound receiver

| | | | |
|----------|------------------------------------|------|----------|
| 6774 99* | Bluetooth sound diffusion 2 module | 4600 | 1/10/100 |
|----------|------------------------------------|------|----------|

Rotary dimmer universal

| | | | |
|---------|---------------------------------|------|----------|
| 6774 24 | Rotary led dimmer 50 W 1 module | 2148 | 1/10/120 |
|---------|---------------------------------|------|----------|

Accessories

| | | | |
|---------|----------------------------|-----|--------|
| 6774 75 | Cable outlet 8 mm 1 module | 146 | 20/200 |
| 6774 76 | Blanking plate 1 module | 34 | 20/200 |

Lyncus plate frame white

| | | | |
|---------|---------------------------------|-----|--------|
| 6775 01 | Classic white plate + Frame 1 M | 90 | 20/200 |
| 6775 02 | Classic white plate + Frame 2 M | 90 | 20/200 |
| 6775 03 | Classic white plate + Frame 3 M | 116 | 10/100 |

Bold Cat.Nos are products normally available with Legrand (India) Stockists. Cat.Nos that are not bold - delivery within 4 - 8 weeks from the date of order. Bold packing quantity is our mandatory packing. Orders to be placed by Legrand (India) Stockist in multiples of the same.

Lyncus™ plate frame

NEW!

| Cat.Nos | Description | MRP* ₹ / Unit | Pack |
|---------|-------------|------------------|------|
|---------|-------------|------------------|------|

Lyncus plate frame white

| | | | |
|---------|-------------------------------------|-----|--------|
| 6775 04 | Classic white plate + Frame 4 M | 126 | 10/100 |
| 6775 06 | Classic white plate + Frame 6 M | 160 | 5/50 |
| 6775 08 | Classic white plate + Frame 8 M (H) | 208 | 5/50 |
| 6775 09 | Classic white plate + Frame 2 x 4 M | 214 | 5/25 |
| 6775 12 | Classic white plate + Frame 12 M | 296 | 10 |
| 6775 16 | Classic white plate + Frame 16 M | 346 | 10 |
| 6775 18 | Classic white plate + Frame 18 M | 464 | 10 |

Plate frame chic grey

| | | | |
|---------|---------------------------------|-----|--------|
| 6775 21 | Chic grey plate+Frame 1 M | 112 | 20/200 |
| 6775 22 | Chic grey plate+Frame 2 M | 112 | 20/200 |
| 6775 23 | Chic grey plate+Frame 3 M | 154 | 10/100 |
| 6775 24 | Chic grey plate+Frame 4 M | 162 | 10/100 |
| 6775 26 | Chic grey plate+Frame 6 M | 208 | 5/50 |
| 6775 28 | Chic grey plate + Frame 8 M (H) | 274 | 5/50 |
| 6775 29 | Chic grey plate + Frame 2x4 M | 274 | 5/25 |
| 6775 32 | Chic grey plate + Frame 12 M | 386 | 10 |
| 6775 36 | Chic grey plate + Frame 16 M | 444 | 10 |
| 6775 38 | Chic grey plate + Frame 18 M | 608 | 10 |

Plate frame brushed

| | | | |
|---------|--------------------------------------|-----|--------|
| 6775 41 | Brushed silver plate + Frame 1 M | 118 | 20/200 |
| 6775 42 | Brushed silver plate + Frame 2 M | 118 | 20/200 |
| 6775 43 | Brushed silver plate + Frame 3 M | 162 | 10/100 |
| 6775 44 | Brushed silver plate + Frame 4 M | 170 | 10/100 |
| 6775 46 | Brushed silver plate + Frame 6 M | 220 | 5/50 |
| 6775 48 | Brushed silver plate + Frame 8 M (H) | 286 | 5/50 |
| 6775 49 | Brushed silver plate + Frame 2x4 M | 286 | 5/25 |
| 6775 52 | Brushed silver plate + Frame 12 M | 406 | 10 |
| 6775 56 | Brushed silver plate + Frame 16 M | 468 | 10 |
| 6775 58 | Brushed silver plate + Frame 18 M | 638 | 10 |

Plate frame alu sun set

| | | | |
|---------|---------------------------------|-----|--------|
| 6775 61 | Alu sun set plate + Frame 1 M | 116 | 20/200 |
| 6775 62 | Alu sun set plate + Frame 2 M | 116 | 20/200 |
| 6775 63 | Alu sun set plate + Frame 3 M | 154 | 10/100 |
| 6775 64 | Alu sun set plate + Frame 4 M | 168 | 10/100 |
| 6775 66 | Alu sun set plate + Frame 6 M | 214 | 5/50 |
| 6775 68 | Alu sun set plate + Frame 8 M | 274 | 5/50 |
| 6775 69 | Alu sun set plate + Frame 2x4 M | 278 | 5/25 |
| 6775 72 | Alu sun set plate + Frame 12 M | 398 | 10 |
| 6775 76 | Alu sun set plate + Frame 16 M | 456 | 10 |
| 6775 78 | Alu sun set plate + Frame 18 M | 624 | 10 |

Lyncus™

NEW!

| Cat.Nos | Description | MRP* ₹ / Unit | Pack |
|---------|-------------|------------------|------|
|---------|-------------|------------------|------|

Plate frame champagne

| | | | |
|---------|---------------------------------|-----|--------|
| 6775 81 | Champagne plate + Frame 1 M | 116 | 20/200 |
| 6775 82 | Champagne plate + Frame 2 M | 116 | 20/200 |
| 6775 83 | Champagne plate + Frame 3 M | 154 | 10/100 |
| 6775 84 | Champagne plate + Frame 4 M | 168 | 10/100 |
| 6775 86 | Champagne plate + Frame 6 M | 214 | 5/50 |
| 6775 88 | Champagne plate + Frame 8 M (H) | 274 | 5/50 |
| 6775 89 | Champagne plate + Frame 2x4 M | 278 | 5/25 |
| 6775 92 | Champagne plate + Frame 12 M | 398 | 10 |
| 6775 96 | Champagne plate + Frame 16 M | 456 | 10 |
| 6775 98 | Champagne plate + Frame 18 M | 624 | 10 |

Plate frame matt silver

| | | | |
|---------|-----------------------------------|-----|--------|
| 6776 01 | Matt silver plate + Frame 1 M | 116 | 20/200 |
| 6776 02 | Matt silver plate + Frame 2 M | 116 | 20/200 |
| 6776 03 | Matt silver plate + Frame 3 M | 154 | 10/100 |
| 6776 04 | Matt silver plate + Frame 4 M | 168 | 10/100 |
| 6776 06 | Matt silver plate + Frame 6 M | 214 | 5/50 |
| 6776 08 | Matt silver plate + Frame 8 M (H) | 274 | 5/50 |
| 6776 09 | Matt silver plate + Frame 2x4 M | 278 | 5/25 |
| 6776 12 | Matt silver plate + Frame 12 M | 398 | 10 |
| 6776 16 | Matt silver plate + Frame 16 M | 456 | 10 |
| 6776 18 | Matt silver plate + Frame 18 M | 624 | 10 |

Mounting boxes

Metal flush boxes

| | | | |
|---------|--------------------------------------|-----|----|
| 6890 07 | Flush box - 1/2 module | 102 | 40 |
| 6890 08 | Flush box - 3 module | 102 | 40 |
| 6890 09 | Flush box - 4 module | 138 | 40 |
| 6890 10 | Flush box - 6 module | 218 | 40 |
| 6890 42 | Flush box - 8 module | 256 | 40 |
| 6890 31 | Flush box - 8 module (2 row x 4) | 254 | 20 |
| 6890 11 | Flush box - 12/16 (2 row x 6) module | 384 | 10 |
| 6890 12 | Flush box - 18 module | 484 | 10 |

Plastic surface boxes

| | | | |
|---------|----------------------------------|-----|-------|
| 6733 02 | Surface box 1/2 module | 70 | 10/50 |
| 6733 03 | Surface box 3 module | 84 | 5/35 |
| 6733 04 | Surface box 4 module | 96 | 5/25 |
| 6733 06 | Surface box 6 module | 124 | 1/10 |
| 6733 08 | Surface box 8 module | 184 | 1/5 |
| 6733 05 | Surface box 8 (2 row x 4) module | 178 | 1/5 |

Metal surface boxes

| | | | |
|---------|--------------------------------------|-----|-----|
| 6890 21 | Surface box 12/16 (2 row x 6) module | 440 | 1/6 |
| 6890 22 | Surface box 18 module | 466 | 1/4 |

* MRP - Maximum Retail Price Inclusive of all taxes including GST.
To be Introduced Shortly
Red Cat.Nos - new products

Bold Cat.Nos are products normally available with Legrand (India) Stockists.
Cat.Nos that are not bold - delivery within 4 - 8 weeks from the date of order.
Bold packing quantity is our mandatory packing. Orders to be placed by Legrand (India) Stockist in multiples of the same.

Britzy™ SWITCHES

**THE
NO PROBLEM
SWITCH**



Now Available In 4 New Colours

BritzyTM SWITCHES

RANGE



Switch 6 A, 16 A



Switch 6 A two-way



Switch with indicator
6 A, 16 A, 25 A



Bell push with
indicator - 1 module



DP Switch 20 A, 32 A



Bell push with
indicator - 2 module



DND internal unit



DND external unit



Universal socket
6 A - 3 pin



Multi-standard socket



6/16 A socket



Euro US socket



Dimmer



Fan regulator
1 module



Fan regulator
2 module



USB charger
1 module



USB charger
2 module



RJ 45



RJ 11 Telephone socket



Double RJ 11
Telephone socket



Bell call indicator



TV socket



Skirting light



Buzzer



Key card Switch 16 A











Flat indicator red

Britzy™ switches

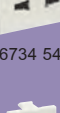

| Cat.Nos | Description | MRP* ₹ / Unit | Pack |
|---------|-------------|---------------------|------|
|---------|-------------|---------------------|------|

Switches

- All switches are ISI marked as per latest IS 3854:1997
- Finger-proof terminal for protection against accidental contact
- Laser marking for easy identification





| | | | |
|---|--|-----|--------|
|  6734 01 | 6 A Switch SP 1 way 1 module | 42 | 20/200 |
|  6734 02 | 6 A Switch SP 2 way 1 module | 88 | 20/200 |
|  6734 03 | 6 A Switch SP 1 way with indicator 1 module | 86 | 20/200 |
|  6734 11 | 16 A Switch SP 1 way 1 module | 124 | 20/200 |
|  6734 12 | 16 A Switch SP 2 way 1 module | 146 | 20/200 |
|  6734 13 | 16 A Switch SP 1 way with indicator 1 module | 134 | 20/200 |
|  6734 24 | 25 A Switch SP 1 way with indicator 1 module | 168 | 20/200 |
|  6734 25 | 20 A DP switch with indicator 2 modules | 188 | 10/100 |
|  6734 26 | 32 A DP switch with indicator 2 modules | 252 | 10/100 |

Push buttons

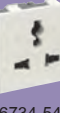

| | | | |
|---|---|-----|--------|
|  6734 04 | 6 A Bell push with indicator module 1 | 100 | 20/200 |
|  6734 06 | 6 A Bell push with indicator 2 module | 152 | 10/100 |

Sockets

- Confirming to IS 1293:2005
- Shuttered socket for child safety
- Shutter open only with phase and neutral insertion simultaneously

| | | | |
|---|--|-----|--------|
|  6734 52 | 6 A 3 pin universal socket 2 modules | 102 | 10/100 |
|  6734 53 | Euro US socket 1 module | 86 | 20/200 |
|  6734 55 | 6/16 A socket 3 Pin 2 modules | 166 | 10/100 |
|  6734 56 | 25 A socket 3 Pin 2 modules | 188 | 10/100 |
|  6734 54 | Multistandard socket 2 modules | 148 | 10/100 |

Data & voice

| | | | |
|---|---|-----|--------|
|  6734 41 | RJ11 telephone socket 1 module | 86 | 20/200 |
|  6734 44 | Double RJ11 telephone socket 1 module | 126 | 20/200 |
|  6734 45 | RJ45 Cat 6 computer socket 1 module | 244 | 20/200 |

- * MRP - Maximum Retail Price Inclusive of all taxes including GST.
- To be Introduced Shortly

Britzy™ switches

| Cat.Nos | Description | MRP* ₹ / Unit | Pack |
|---------|-------------|---------------------|------|
|---------|-------------|---------------------|------|



Television socket

| | | | |
|---|---------------------------|----|--------|
|  6734 46 | TV socket 1 module | 80 | 20/200 |
|---|---------------------------|----|--------|

Buzzer

| | | | |
|---|---------------------------------|-----|--------|
|  6734 40 | Buzzer 230 V 1 module | 264 | 20/200 |
|---|---------------------------------|-----|--------|

Dimmer & regulator

| | | | |
|---|---|-----|--------|
|  6734 31 | Fan regulator 100 W 1 module | 358 | 5/50 |
|  6734 30 | Fan regulator 100 W 2 modules | 452 | 10/100 |
|  6734 33 | Light dimmer 400 W 1 module | 366 | 5/50 |



Bell indicator

| | | | |
|---|------------------------------|-----|--------|
|  6734 07 | Bell call indicator 1 module | 502 | 20/200 |
|---|------------------------------|-----|--------|



Motor starter

| | | | |
|---|--|-----|--------|
|  6734 66 | 25 A Motor starter 2 modules | 416 | 10/100 |
|---|--|-----|--------|

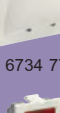
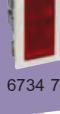
Modular MCB (IS : 60898-1:2002)

| | | | |
|---|--------------------|-----|----------|
|  6734 64 | Modular SP MCB 16A | 296 | 1/10/100 |
|  6734 61 | Modular SP MCB 20A | 296 | 1/10/100 |
|  6734 36 | Modular SP MCB 25A | 296 | 1/10/100 |
|  6734 37 | Modular SP MCB 32A | 296 | 1/10/100 |

USB Charger

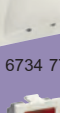
| | | | |
|---|---------------------------------|------|--------|
|  6734 34 | USB charger 1M 1000mA | 630 | 10/100 |
|  6734 35 | USB charger 1M 1500mA | 724 | 10/100 |
|  6734 35 | Double USB charger 2M 2000mA | 1062 | 5/50 |

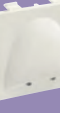

Skirting light

| | | | |
|---|---------------------------------|-----|------|
|  6734 77 | Skirting light 2 modules | 348 | 5/50 |
|---|---------------------------------|-----|------|

Indicator

| | | | |
|---|------------------------------------|----|--------|
|  6734 75 | Flat indicator red 1 module | 92 | 20/200 |
|---|------------------------------------|----|--------|



Key card switch

| | | | |
|---|--|------|------|
|  6734 80 | 16 A Key card switch 2 modules | 1890 | 1/10 |
|  6734 83 | Keyfob credit card size for 6734 80 | 144 | 1/10 |

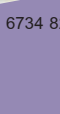
Do Not Disturb indicator & internal control unit

| | | | |
|---|---------------------------------------|-----|--------|
|  6734 81 | DND internal unit 2 modules | 166 | 10/100 |
|  6734 82 | DND external unit 2 modules | 198 | 10/100 |

Accessories

| | | | |
|---|---------------------------------|----|--------|
|  6734 71 | Cable outlet 1 module | 70 | 20/200 |
|  6734 90 | Blanking plate 1 module | 26 | 20/200 |
|  6734 72 | Blanking plate 2 modules | 34 | 10/100 |

Bold Cat.Nos are products normally available with Legrand (India) Stockists. Cat.Nos that are not bold - delivery within 4 - 8 weeks from the date of order. Bold packing quantity is our mandatory packing. Orders to be placed by Legrand (India) Stockist in multiples of the same.

Britzy™ switches

| Cat.Nos | Description | MRP* ₹ / Unit | Pack |
|---------|-------------|------------------|------|
|---------|-------------|------------------|------|

White plates with frame

Sleek and curvy plates with elegant looks comes with sturdy support frame for solid strength

| | | | |
|----------------|---|-----|--------|
| 6734 91 | Plate & frame 86 x 86 1 module | 64 | 20/200 |
| 6734 92 | Plate & frame 86 x 86 2 modules | 64 | 20/200 |
| 6734 93 | Plate & frame 121 x 86 3 modules | 84 | 10/100 |
| 6734 94 | Plate & frame 146 x 86 4 modules | 90 | 10/100 |
| 6734 96 | Plate & frame 224 x 86 6 modules | 118 | 5/50 |
| 6734 98 | Plate & frame 245 x 86 8 modules | 154 | 5/50 |
| 6734 95 | Plate & frame 146 x 172 4 x 2 modules | 154 | 5/25 |
| 6734 97 | Plate & frame 224 x 172 12 modules | 220 | 10 |
| 6734 99 | Plate & frame 245 x 172 16 modules | 240 | 10 |
| 6735 00 | Plate & frame 224 x 240 18 modules | 296 | 10 |

WARM ORANGE SILVER plates with frame

| | | | |
|---------|---|-----|--------|
| 6735 01 | Plate & frame 86 x 86 1 module | 100 | 20/200 |
| 6735 02 | Plate & frame 86 x 86 2 modules | 100 | 20/200 |
| 6735 03 | Plate & frame 121 x 86 3 modules | 126 | 10/100 |
| 6735 04 | Plate & frame 146 x 86 4 modules | 152 | 10/100 |
| 6735 05 | Plate & frame 224 x 86 6 modules | 212 | 5/50 |
| 6735 06 | Plate & frame 245 x 86 8 modules | 226 | 5/50 |
| 6735 07 | Plate & frame 146 x 172 4 x 2 modules | 278 | 5/25 |
| 6735 08 | Plate & frame 224 x 172 12 modules | 386 | 10 |
| 6735 09 | Plate & frame 245 x 172 16 modules | 518 | 10 |
| 6735 10 | Plate & frame 224 x 240 18 modules | 596 | 10 |

HERB BEIGE plates with frame

| | | | |
|---------|--|-----|--------|
| 6735 11 | Plate & frame 86 x 86 1 module | 100 | 20/200 |
| 6735 12 | Plate & frame 86 x 86 2 modules | 100 | 20/200 |
| 6735 13 | Plate & frame 121 x 86 3 modules | 126 | 10/100 |
| 6735 14 | Plate & frame 146 x 86 4 modules | 152 | 10/100 |
| 6735 15 | Plate & frame 224 x 86 6 modules | 212 | 5/50 |
| 6735 16 | Plate & frame 245 x 86 8 modules | 226 | 5/50 |

* MRP - Maximum Retail Price Inclusive of all taxes including GST.
To be Introduced Shortly

Britzy™ switches

| Cat.Nos | Description | MRP* ₹ / Unit | Pack |
|---------|-------------|------------------|------|
|---------|-------------|------------------|------|

NEW! HERB BEIGE plates with frame

| | | | |
|---------|---|-----|------|
| 6735 17 | Plate & frame 146 x 172 4 x 2 modules | 278 | 5/25 |
| 6735 18 | Plate & frame 224 x 172 12 modules | 386 | 10 |
| 6735 19 | Plate & frame 245 x 172 16 modules | 518 | 10 |
| 6735 20 | Plate & frame 224 x 240 18 modules | 596 | 10 |

NEW! URBAN BRONZE plates with frame

| | | | |
|---------|---|-----|--------|
| 6735 21 | Plate & frame 86 x 86 1 module | 100 | 20/200 |
| 6735 22 | Plate & frame 86 x 86 2 modules | 100 | 20/200 |
| 6735 23 | Plate & frame 121 x 86 3 modules | 126 | 10/100 |
| 6735 24 | Plate & frame 146 x 86 4 modules | 152 | 10/100 |
| 6735 25 | Plate & frame 224 x 86 6 modules | 212 | 5/50 |
| 6735 26 | Plate & frame 245 x 86 8 modules | 226 | 5/50 |
| 6735 27 | Plate & frame 146 x 172 4 x 2 modules | 278 | 5/25 |
| 6735 28 | Plate & frame 224 x 172 12 modules | 386 | 10 |
| 6735 29 | Plate & frame 245 x 172 16 modules | 518 | 10 |
| 6735 30 | Plate & frame 224 x 240 18 modules | 596 | 10 |

NEW! ORANGE CHROME plates with frame

| | | | |
|----------|---|-----|--------|
| 6735 31# | Plate & frame 86 x 86 1 module | 100 | 20/200 |
| 6735 32# | Plate & frame 86 x 86 2 modules | 100 | 20/200 |
| 6735 33# | Plate & frame 121 x 86 3 modules | 126 | 10/100 |
| 6735 34# | Plate & frame 146 x 86 4 modules | 152 | 10/100 |
| 6735 35# | Plate & frame 224 x 86 6 modules | 212 | 5/50 |
| 6735 36# | Plate & frame 245 x 86 8 modules | 226 | 5/50 |
| 6735 37# | Plate & frame 146 x 172 4 x 2 modules | 278 | 5/25 |
| 6735 38# | Plate & frame 224 x 172 12 modules | 386 | 10 |
| 6735 39# | Plate & frame 245 x 172 16 modules | 518 | 10 |
| 6735 40# | Plate & frame 224 x 240 18 modules | 596 | 10 |

Bold Cat.Nos are products normally available with Legrand (India) Stockists. Cat.Nos that are not bold - delivery within 4 - 8 weeks from the date of order. Bold packing quantity is our mandatory packing. Orders to be placed by Legrand (India) Stockist in multiples of the same.

Britzy™ switches

| Cat.Nos | Description | MRP* ₹ / Unit | Pack |
|---------|-------------|---------------------|------|
|---------|-------------|---------------------|------|

Flush mounting boxes - Metal

- Boxes are with top, bottom, side and back wall knockout for conduit entry from any direction
- Possible to break open knockout without any special tool



6890 60



6890 61

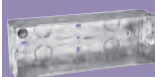

6890 63

| | | | |
|---------|---|-----|----|
| 6890 60 | Metal flush box 75.7 x 75.7 x 50.8 1 & 2 modules | 56 | 40 |
| 6890 61 | Metal flush box 98.9 x 75.7 x 50.8 3 modules | 70 | 40 |
| 6890 62 | Metal flush box 136 x 75.7 x 50.8 4 modules | 90 | 40 |
| 6890 63 | Metal flush box 213.4 x 75.7 x 50.8 6 modules | 136 | 40 |
| 6890 64 | Metal flush box 136.6 x 136.8 x 61 8 (2 rows x 4) modules | 174 | 20 |
| 6890 65 | Metal flush box 231.2 x 75.7 x 50.8 8 modules | 174 | 40 |
| 6890 66 | Metal flush box 215 x 145.3 x 61.2 12 (2 rows x 6) modules | 244 | 10 |
| 6890 67 | Metal flush box 232.8 x 147.4 x 61.2 16 (2 rows x 8) modules | 272 | 10 |
| 6890 68 | Metal flush box 215 x 213.3 x 61.2 18 modules | 312 | 10 |

Surface mounting boxes - Plastic

| | | | |
|---------|---|-----|-------|
| 6890 70 | Plastic surface box 86 x 86 x 45 1 & 2 modules | 50 | 10/50 |
| 6890 71 | Plastic surface box 121 x 86 x 45 3 modules | 64 | 5/35 |
| 6890 72 | Plastic surface box 146 x 86 x 45 4 modules | 78 | 5/25 |
| 6890 73 | Plastic surface box 224 x 86 x 45 6 modules | 120 | 1/10 |
| 6890 74 | Plastic surface box 146 x 172 x 45 8 (2 rows x 4) modules | 168 | 2/10 |
| 6890 75 | Plastic surface box 245.2 x 86 x 45 8 modules | 168 | 1/10 |
| 6890 76 | Plastic surface box 224 x 172 x 45 12 (2 rows x 6) modules | 206 | 1/10 |
| 6890 77 | Plastic surface box 245.2 x 172 x 45 16 (2 rows x 8) modules | 238 | 1/10 |

Surface mounting boxes - Metal

| | | | |
|---------|--|-----|------|
| 6890 78 | Metal surface box 18 modules | 254 | 1/10 |
|---------|--|-----|------|

- * MRP - Maximum Retail Price Inclusive of all taxes including GST.
- To be Introduced Shortly

Britzy™

THE NO PROBLEM SWITCH

Guarantee

- The Company, at its discretion, will replace products if they have any manufacturing defect within 10 years for switches (without LED lamp) and power sockets. For all other **Britzy™** wiring accessories the guarantee will be 2 years.
- The above guarantee is applicable when the devices are used in Legrand metal flush boxes. Otherwise the guarantee period will be reduced by 50%.
- The guarantee is only applicable when the products are installed as per the Company's instructions and not tampered in any manner.
- The guarantee states the Company's entire liability. It does not extend to cover consequential loss or damage or installation costs arising from defective products.

WORKSTATION SOLUTIONS

POWER AND DATA DISTRIBUTION FOR THE OFFICE ENVIRONMENT

In order to guarantee convenience and performance for users in office buildings, workstations & different areas must be fitted with solutions that can be fully adjusted to different building infrastructures and still meet the user's connectivity and mobility needs.

These ranges of products are solutions for supplying and fitting out workstations in any kind of building infrastructure: Raised Floor, Flush Floor, Screed Floor & False Ceiling & Wall.



Pop-up boxes - for floor

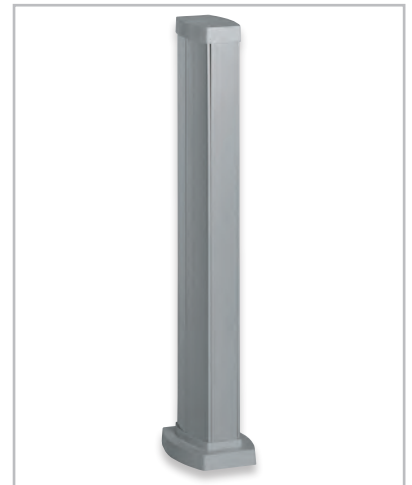

Snap-On mini-columns

LEGRAND'S SOLUTION FOR DISTRIBUTING POWER AND DATA TO WORKSTATIONS

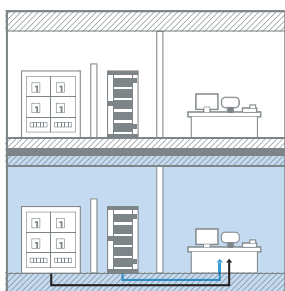

Work station solution supplied through the floor

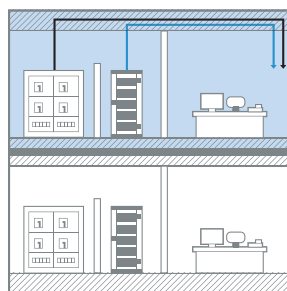

Work station solution supplied through the false ceiling & the wall

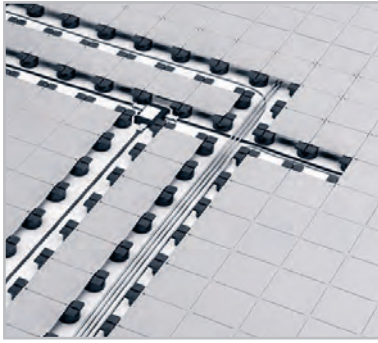

Soluflex cable floor system

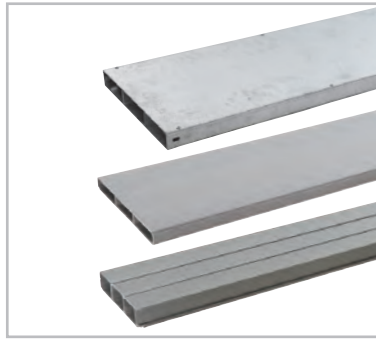

Raceways : PVC & Metal (GI)



Floor boxes



Raceways : PVC & Metal (GI)



Power & data desk grommets



Dlp trunking system:
Snap-on, Mini & PVC, Aluminium

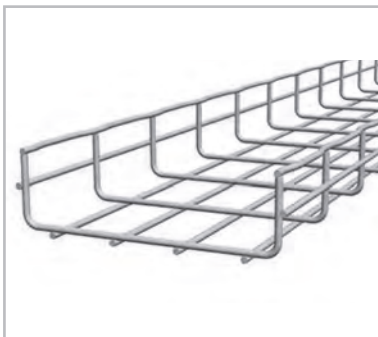

Cablofil wire mesh cable trays



Cable worm



Flush mounting power & data module

POWER AND DATA DISTRIBUTION & CONNECTION SOLUTIONS

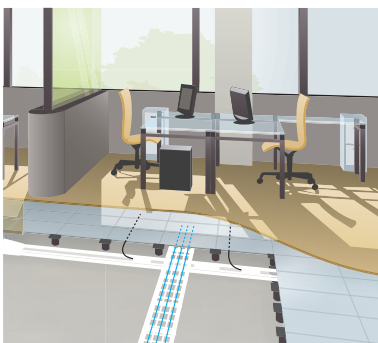

Raised access floor systems



Screed floor system



Wall and ceiling systems

Raceways and junction boxes for screed floors



| Cat.Nos | Description | MRP* ₹ / Unit | Pack |
|---------|-------------|------------------|------|
|---------|-------------|------------------|------|

Confirms to EN 50 085 - 2 - 2
Raceways are made from PVC and Galvanised sheet.
Compatible with Cat.6 structured cabling system.

Raceways - PVC

**Raceways - PVC - height 38 mm;
Standard length 2 meters⁽¹⁾; Price per meter**

| | | | |
|---------|---------------------------------|------|----|
| 0896 67 | 50 mm x 38 mm - 1 compartment | 924 | 12 |
| 0896 68 | 100 mm x 38 mm - 2 compartments | 1732 | 16 |
| 0896 69 | 150 mm x 38 mm - 3 compartments | 2600 | 10 |

Raceways - Metal / GI

**Raceways - Metal/GI - height 25 mm; length 2.44 m.
Price per unit (One unit is of 2.44 meters)**

| | | | |
|---------|---------------------------------|------|---------------------|
| 6895 10 | 50 mm x 25 mm - 1 compartment | 1612 | 3/54 ⁽¹⁾ |
| 6895 11 | 75 mm x 25 mm - 1 compartment | 2076 | 3/21 ⁽¹⁾ |
| 6895 12 | 100 mm x 25 mm - 1 compartment | 2522 | 3/54 ⁽¹⁾ |
| 6895 13 | 150 mm x 25 mm - 1 compartment | 3494 | 3/18 ⁽¹⁾ |
| 6895 14 | 225 mm x 25 mm - 3 compartments | 5474 | 3/12 ⁽¹⁾ |
| 6895 15 | 300 mm x 25 mm - 3 compartments | 6780 | 3/18 ⁽¹⁾ |

**Raceways - Metal/GI - height 38 mm; length 2.44 m
Price per unit (One unit is of 2.44 meters)**

| | | | |
|---------|---------------------------------|------|---------------------|
| 6895 00 | 50 mm x 38 mm - 1 compartment | 1872 | 3/54 ⁽¹⁾ |
| 6895 01 | 75 mm x 38 mm - 1 compartment | 2474 | 3/21 ⁽¹⁾ |
| 6895 02 | 100 mm x 38 mm - 1 compartment | 2994 | 3/54 ⁽¹⁾ |
| 6895 03 | 150 mm x 38 mm - 1 compartment | 4014 | 3/36 ⁽¹⁾ |
| 6895 04 | 225 mm x 38 mm - 3 compartments | 6074 | 3/12 ⁽¹⁾ |
| 6895 05 | 300 mm x 38 mm - 3 compartments | 7444 | 3/18 ⁽¹⁾ |

Raceways accessories

Fixing bracket (GI)

For fixing raceways (PVC & Metal) on the floor

| | | | |
|---------|-------------------------------|-----|---|
| 6897 09 | 50 mm x 25 mm (metal) | 26 | 9 |
| 6897 10 | 75 mm x 25 mm (PVC and metal) | 44 | 9 |
| 6897 12 | 100 mm x 25 mm (metal) | 50 | 9 |
| 6897 15 | 150 mm x 25 mm (metal) | 64 | 9 |
| 6897 20 | 225 mm x 25 mm (metal) | 90 | 9 |
| 6897 30 | 300 mm x 25 mm (metal) | 120 | 9 |

Fixing bracket

| | | | |
|---------|--------------------------------|-----|---|
| 6897 27 | 50 mm x 38 mm (PVC and metal) | 28 | 9 |
| 6897 28 | 75 mm x 38 mm (metal) | 50 | 9 |
| 6897 37 | 100 mm x 38 mm (PVC and metal) | 58 | 9 |
| 6897 38 | 150 mm x 38 mm (PVC and metal) | 72 | 9 |
| 6897 25 | 225 mm x 38 mm (metal) | 112 | 9 |
| 6897 35 | 300 mm x 38 mm (metal) | 140 | 9 |

Riser

| | | | |
|---------|--------------------------------------|------|---|
| 6897 23 | Vertical - for 225 mm width raceways | 1946 | 1 |
| 6897 33 | Vertical - for 300 mm width raceways | 2240 | 1 |

* MRP - Maximum Retail Price Inclusive of all taxes including GST.
(1) Unit of measure in Nos
¹To be ordered in multiples of 2 meters

Raceways and junction boxes for screed floors



| Cat.Nos | Description | MRP* ₹ / Unit | Pack |
|---------|-------------|------------------|------|
|---------|-------------|------------------|------|

Coupler for joining raceways

| | | | |
|---------|-------------|-----|---|
| 6897 77 | Coupling 38 | 118 | 6 |
| 6897 79 | Coupling 25 | 88 | 6 |

Junction box

For direct access to cables at the intersection of raceways
Supplied completely with base and cover plate (Lid)

Height adjustable junction box 65 - 90 mm

| | | | |
|---------|------------------------|------|---|
| 6896 10 | 150 x 150 x 65 - 90 mm | 2158 | 1 |
| 6896 11 | 225 x 225 x 65 - 90 mm | 2674 | 1 |
| 6896 12 | 300 x 300 x 65 - 90 mm | 3524 | 1 |
| 6896 13 | 400 x 400 x 65 - 90 mm | 5332 | 1 |

Height adjustable junction box 65 - 90 mm with fly over

For direct access to cables at the intersection of floor raceways while maintaining perfect separation and 900 cross overs between data and power cables

| | | | |
|---------|-------------------------------------|------|---|
| 6896 14 | 225 x 225 x 65 - 90 mm with flyover | 2954 | 1 |
| 6896 15 | 300 x 300 x 65 - 90 mm with flyover | 3934 | 1 |
| 6896 16 | 400 x 400 x 65 - 90 mm with flyover | 5900 | 1 |

Optional site cover for junction box

| | | | |
|---------|---|-----|----|
| 6896 18 | 150 x 150 x 65 - 90 mm with metal cover | 242 | 10 |
| 6896 19 | 225 x 225 x 65 - 90 mm with metal cover | 346 | 10 |
| 6896 20 | 300 x 300 x 65 - 90 mm with metal cover | 524 | 10 |
| 6896 21 | 400 x 400 x 65 - 90 mm with metal cover | 794 | 10 |

Height adjustable junction box 50 - 70 mm

| | | | |
|---------|----------------------|------|---|
| 6896 22 | 150 x 150 x 50-70 mm | 2006 | 1 |
| 6896 23 | 225 x 225 x 50-70 mm | 2464 | 1 |
| 6896 24 | 300 x 300 x 50-70 mm | 3246 | 1 |
| 6896 25 | 400 x 400 x 50-70 mm | 4868 | 1 |

Floor boxes for carpet for raised floor, screed floor

Floor boxes for raised floor

| | | | |
|---------|---|------|---|
| 6896 38 | Full backbox for raised floor - 3 compartments (264x264 mm) height 86 mm | 3426 | 1 |
| 6896 31 | Lid & trim Grey cover RAL 7031 for 3 compartment floor box with flexible cable exits Size 265 mm x 265 mm | 2584 | 5 |

Support plates for floor boxes 77 mm width plate

| | | | |
|---------|--|-----|----|
| 6896 62 | Blank plates for floor box | 288 | 12 |
| 6896 17 | Flat support plate 8 module for integration of Myrius mechanisms | 288 | 1 |
| 6896 78 | Waved support plates. For 4 modules (2 x 2 modules) | 876 | 4 |

Bold Cat.Nos are products normally available with Legrand (India) Stockists. Cat.Nos that are not bold - delivery within 4 - 8 weeks from the date of order. Bold packing quantity is our mandatory packing. Orders to be placed by Legrand (India) Stockist in multiples of the same.

Floor boxes for carpet for raised floor, screed floor

| Cat.Nos | Description | MRP* ₹ / Unit | Pack |
|---------|-------------|------------------|------|
|---------|-------------|------------------|------|

Floor boxes for screed floor (3 Compartment)

| | | | |
|----------|--|------|---|
| 6896 34* | Full backbox for screed floor 3 compartments (for ducting upto 225 mm). Height adjustable to screed height 65 to 90 mm | 5306 | 1 |
| 6896 31* | Lid & trim Grey cover RAL 7031 for 3 compartment floor box with flexible cable exits. Size 265 mm x 265 mm | 2584 | 5 |



6896 34 +
6896 31

Support plates for floor boxes 77 mm width plate

| | | | |
|---------|--|-----|----|
| 6896 62 | Blank plates for floor box | 288 | 12 |
| 6896 17 | Flat support plate 8 module for integration of Myrius mechanisms | 288 | 1 |
| 6896 78 | Waved support plates for 4 modules (2x2 modules) | 876 | 4 |

Floor boxes for screed floor (4 Compartment)

| | | | |
|---------|--|------|---|
| 6896 45 | Full backbox for screed floor - 4 compartments (for ducting upto 300 mm) Height adjustable to screed height 65 to 90 mm. To be used with 6896 45 | 5902 | 1 |
| 6896 41 | Lid & trim Grey cover RAL 1019 for 4 compartment floor box with flexible cable exits. To be used with 6896 41 | 2836 | 5 |

Support plates for floor boxes

77 mm width plate

| | | | |
|---------|---|-----|----|
| 6896 62 | Blank plates for floor box | 288 | 12 |
| 6896 17 | Flat support plate 8 module for integration of Myrius | 288 | 1 |
| 6896 78 | Waved support plates For 4 Modules (2x2 Modules) mechanisms | 876 | 4 |

Stainless steel insert for Lid

For a metal finish on lid

To be used instead of fitting carpet onto the Lid

| | | | |
|---------|--|------|---|
| 6896 92 | For 3 compartment floor boxes dimension : 245.5x210 mm | 3192 | 1 |
|---------|--|------|---|

Floor boxes for tile / marble

for screed floor

| | | | |
|---------|--|-------|---|
| 0896 04 | Backbox for screed floor; Screed thickness 65 to 90 mm | 4578 | 1 |
| 6896 52 | Lid & trim for tiles / marble 15 to 22 mm thickness Stainless steel material AISI 304. 2 cable outlet | 22240 | 1 |
| 6896 55 | Lid & Trim for tile 8-15 mm thickness Material for head band & single cable outlet - galvanised steel + paint RAL 7031 | 6098 | 1 |



0896 04 +
6896 52

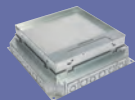

0896 04 +
6896 55

* MRP - Maximum Retail Price Inclusive of all taxes including GST.
6896 34 + 6896 31 with support plates and wiring devices

Floor boxes for tile / marble

| Cat.Nos | Description | MRP* ₹ / Unit | Pack |
|---------|-------------|------------------|------|
|---------|-------------|------------------|------|

for screed floor

| | | | |
|---------|--|------|---|
| 6896 56 | Lid & Trim for tile 8-15 mm thickness Material for head band & single cable outlet - stainless steel 304 | 7432 | 1 |
|---------|--|------|---|

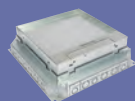

0896 04 +
6896 56

Support plates for floor boxes

77 mm width plate

| | | | |
|---------|---|-----|----|
| 6896 62 | Blank plates for floor box | 288 | 12 |
| 6896 17 | Flat support plate 8 module for integration of Myrius | 288 | 1 |
| 6896 78 | Waved support plates For 4 Modules (2x2 Modules) mechanisms | 876 | 4 |

50 mm reduced height floor boxes

| | | | |
|---------|--|------|---|
| 0880 73 | Back box for Concrete Floor (to be used with 0880 70) | 6762 | 1 |
| 0880 70 | Lid and Trim for Screed Floor between 50 and 70 mm. With Cover for carpet; grey RAL 7031 Can be equipped with SS finishing plate 0880 72 16 Module | 6678 | 1 |
| 0880 72 | Stainless steel finishing plate for 50 mm floor box | 4162 | 1 |

Heavy duty in-screed floor box

for screed floors

Metal in-screed floor box

| | | | |
|---------|-----------------------------------|-------|---|
| 0896 34 | Universal metal in-screed backbox | 18580 | 1 |
|---------|-----------------------------------|-------|---|

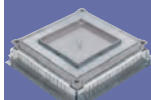

0896 34 +
0896 83 +
0896 85

Accessories for metal in-screed floor box

| | | | |
|---------|--|-------|---|
| 0896 83 | Normal load support upto 8 KN load with deflection <6 mm | 18580 | 1 |
| 0896 84 | Heavy load support upto 20 KN load with deflection <3 mm | 31412 | 1 |



0896 34 +
0896 83 +
0896 86 +
0896 87

Plates for metal in-screed floor boxes

77 mm width plate

| | | | |
|---------|--|-------|---|
| 0896 85 | IP 66 plain cover (cover closed) access trap for junction. No cable exit | 32304 | 1 |
|---------|--|-------|---|

Heavy duty in screed floor box with cable exit

| | | | |
|---------|---------------------------|-------|---|
| 0896 34 | Metal in-screed floor box | 18580 | 1 |
|---------|---------------------------|-------|---|

Accessories for metal in screed floor box

| | | | |
|---------|---|-------|---|
| 0896 83 | Normal load support upto 8 KN load with deflection <6 mm | 18580 | 1 |
| 0896 84 | Heavy load support up to 20 KN load with deflection <3 mm | 31412 | 1 |

Bold Cat.Nos are products normally available with Legrand (India) Stockists. Cat.Nos that are not bold - delivery within 4 - 8 weeks from the date of order. Bold packing quantity is our mandatory packing. Orders to be placed by Legrand (India) Stockist in multiples of the same.

POP-UP BOXES



Our sleek new ergonomically designed pop-up boxes provide real ease of use and rapid connection solutions for mobile applications such as PCs, mobile phones, audio and video systems.





SLEEK DESIGN

Extra-slim format to blend discreetly into the office furniture or floor



SAFETY AND EASE OF USE

Soft opening cover with damper and push & slide locking system



ELEGANT FINISHES

Aluminium, bronze, stainless steel, black or white - a perfect match for furniture and decor



FUNCTIONALITY AND FLEXIBILITY

Available in 3, 2x3, 4 and 2x4 modules for custom configuration or ready assembled with low and high current functions

Heavy duty in-screed floor box for screed floors

| Cat.Nos | Description | MRP* ₹ / Unit | Pack |
|---|--|------------------|------|
| Plates for metal in-screed floor boxes | | | |
| 0896 86 | IP 66 plate (cover closed and plugs not connected) with central cable exit | 64668 | 1 |
| 0896 87 | IP 14 Cable exit accessory for IP66 cover plate Cat.No 0896 86 be used as a simple access to the floor void | 34558 | - |

Over floor trunking

Conform to Std EN 50085-2-2; For creating a link between trunking, column, mini-column, floor units or protecting cables on passageways Supplied with cover

| | | | |
|---------|--|------|-------------------|
| 0300 92 | Over floor trunking 50 x 12 mm; length 2 m, supplied with cover; 3 Compartments; | 438 | 54 ⁽¹⁾ |
| 0300 11 | Flat angle/floor 50 x 12 | 172 | 10 |
| 0300 12 | Cover joint/floor 50 x 12 | 218 | 10 |
| 0300 93 | Over floor trunking 75 x 18 mm; length 2 m, supplied with cover; 3 compartments; | 598 | 36 ⁽¹⁾ |
| 0300 18 | Flat angle/floor 75 x 18 | 332 | 10 |
| 0300 19 | Cover joint/floor 50 x 12 | 228 | 10 |
| 0328 00 | Over floor trunking 92 x 20 mm; Length 2 m, supplied with cover; 4 Compartments, equipped with 2 adhesive strips for better floor fixing | 1098 | 20 ⁽¹⁾ |
| 0328 07 | End cap for floor duct 92 x 20 | 190 | 10 |
| 0328 03 | Cover joint for floor duct 92 x 20 | 262 | 10 |
| 0328 02 | Flat angle for floor duct 92 x 20 | 476 | 5 |

Floor boxes 3 module for screed floor and raised floor

Floor service outlet boxes - 3 modules

| | | | |
|---------|---|------|---|
| 0896 44 | Floor service outlet box - 3 modules Grey RAL 7031 To be equipped with Arteor Mechanism | 1414 | 1 |
| 0896 49 | Flush mounting box for concrete for Cat.No 0896 44 | 942 | 1 |

IP 66 Floor box - 4 module

Conform to EN 60670-1 and EN 60670-23 standards (when lid is closed) / IP55 (with cable exit accessory Cat.No 0880 62)

| | | | |
|---------|---|-------|---|
| 0880 61 | IP66/IK09 screwed stainl. steel floor box (with removable lid); can be equipped with cable exit accessory Cat. No 0880 62 | 15424 | 1 |
| 0880 64 | IP66/IK09 hinged cover stainl. steel floor box | 18556 | 1 |

Floor boxes 3 module for screed floor and raised floor

| Cat.Nos | Description | MRP* ₹ / Unit | Pack |
|--|--|------------------|------|
| IP 66 Floor box - 4 module | | | |
| Conform to EN 60670-1 and EN 60670-23 standards (when lid is closed) / IP55 (with cable exit accessory Cat.No 0880 62) | | | |
| 0880 69 | Auto adjustable back box for installing IP66 floor boxes in concrete floors; supplied with cover; accepts conduit dia 20 mm; min screed height 65 mm | 2962 | 1 |
| 0880 62 | IP55 cable exit accessory | 17024 | 1 |

Floor access unit for raised floors

IP 20 - IK 08

| | | | |
|---------|---|------|---|
| 0893 07 | Access master box floor box that can be used as a simple access to the floor void | 6602 | 1 |
|---------|---|------|---|

Pop-up type flush-mounting boxes for floor

Pop-up boxes to be equipped

Equipped with "push and slide" locking system to avoid accidental opening by feet
To be equipped with Arteor socket outlets
For installation use the flush-mounting boxes for concrete floors or the kits for raised access floors

3 modules

| | | | |
|---------|--------------------------------|------|---|
| 0540 10 | Matt aluminium finish | 2256 | 1 |
| 0540 15 | Brushed brass | 3222 | 1 |
| 0540 20 | Brushed Stainless steel finish | 3260 | 1 |

4 modules

| | | | |
|---------|--------------------------------|------|---|
| 0540 11 | Matt aluminium finish | 2998 | 1 |
| 0540 16 | Brushed brass | 3818 | 1 |
| 0540 21 | Brushed Stainless Steel finish | 4130 | 1 |
| 0540 26 | Matt black | 3732 | 1 |
| 0540 31 | Glossy white | 3822 | 1 |

6 (2 x 3) modules

| | | | |
|---------|--------------------------------|------|---|
| 0540 12 | Matt aluminium finish | 5016 | 1 |
| 0540 17 | Brushed brass | 6920 | 1 |
| 0540 22 | Brushed stainless steel finish | 7174 | 1 |

8 (2 x 4) modules

| | | | |
|---------|--------------------------------|------|---|
| 0540 13 | Matt aluminium finish | 6208 | 1 |
| 0540 18 | Brushed brass | 8302 | 1 |
| 0540 23 | Brushed stainless steel finish | 8832 | 1 |
| 0540 28 | Matt black | 8000 | 1 |
| 0540 33 | Glossy white | 8046 | 1 |

Retractable accessory for Pop Up

| | | | |
|---------|---|------|---|
| 0540 34 | RJ45 Cat 6 UTP retractable Kit - 1 module | 3058 | 1 |
| 0540 35 | RJ45 Cat 6 FTP retractable Kit - 1 module | 4278 | 1 |
| 0540 36 | USB/ Micro-USB Retractable Kit - 1 module | 2896 | 1 |

Bold Cat.Nos are products normally available with Legrand (India) Stockists. Cat.Nos that are not bold - delivery within 4 - 8 weeks from the date of order. Bold packing quantity is our mandatory packing. Orders to be placed by Legrand (India) Stockist in multiples of the same.

* MRP - Maximum Retail Price Inclusive of all taxes including GST.
(1) Price in Meters; No of meters in Pack, Standard length 2 meters to be ordered in multiple of 2 meters.

Pop-up type flush-mounting boxes for floor

| Cat.Nos | Description | MRP* ₹ / Unit | Pack |
|---------|-------------|------------------|------|
|---------|-------------|------------------|------|

Installation kits for raised access floors

Include an empty receptacle and fixing brackets for raised access floor tiles Compatible with:

- Cat. 6 data cabling
- Audio/video cabling

| | | | |
|---------|-------------------|------|---|
| 0540 05 | 3 modules | 1008 | 1 |
| 0540 06 | 4 modules | 1212 | 1 |
| 0540 07 | 6 (2 x 3) modules | 1682 | 1 |
| 0540 08 | 8 (2 x 4) module | 2074 | 1 |



0540 06

For installation of pop-up floor boxes in concrete floors

Equipped with knockouts for ø 20 and ø 25 mm conduits

Metal flush-mounting boxes

| | | | |
|---------|-------------------|-----|---|
| 0540 00 | 3 modules | 274 | 1 |
| 0540 01 | 4 modules | 364 | 1 |
| 0540 02 | 6 (2 x 3) modules | 580 | 1 |
| 0540 03 | 8 (2 x 4) modules | 726 | 1 |



0540 00

Pop-up type flush-mounting boxes for furniture

Pop-up boxes to be equipped

Slim design for perfect integration into the furniture
To be equipped with Arteor socket outlets
Supplied alongwith installation kits for table top

4 modules

| | | | |
|----------------|-------------------|------|---|
| 6540 14 | Matt Aluminium | 2934 | 1 |
| 6540 00 | Matt steel finish | 3922 | 1 |
| 6540 01 | Glossy White | 3628 | 1 |
| 6540 02 | Matt Black | 3472 | 1 |



6540 00

8 (2 x 4) modules

| | | | |
|----------------|-------------------|------|---|
| 6540 15 | Matt Aluminium | 6078 | 1 |
| 6540 03 | Matt steel finish | 8484 | 1 |
| 6540 04 | Glossy White | 7720 | 1 |
| 6540 05 | Matt Black | 7674 | 1 |

Power & data desk grommets for workstation & meeting room table application

Empty power & data desk grommets

To be equipped with Arteor socket outlets, Easily retro fitted into a 60 to 80 mm diameter hole in current office desks and workspace table tops (by replacing the desk grommet)
Cover opens to 180° angle to prevent breaking

For one 2P+E socket

| | | | |
|----------|--|------|---|
| 0540 70* | White RAL 9003, to be equipped with 1 socket | 2090 | 1 |
| 0540 71* | Black RAL 9017, to be equipped with 1 socket | 1938 | 1 |

0540 70
+ 0540 60

For one 2P+E socket and USB phone charger

Supplied with one USB phone charger output

5 V= 750 mA, to be wired

| | | | |
|----------|---|------|---|
| 0540 72* | White RAL 9003 with USB, to be equipped with 1 socket | 4988 | 1 |
| 0540 73* | Black RAL 9017 with USB, to be equipped with 1 socket | 5434 | 1 |



0540 73

0540 73
+ 0540 62

Power & data desk grommets for workstation & meeting room table application

| Cat.Nos | Description | MRP* ₹ / Unit | Pack |
|---------|-------------|------------------|------|
|---------|-------------|------------------|------|

Pre-wired modules with retractable cords

For fitting on an empty power & data desktop modules (under the table top)

Automatic cable rewind when not connected, for an optimized use of the desk surface

Cat. 6 FTP

| | | | |
|---------|--|------|---|
| 0540 65 | Equipped with - 1.35 m RJ 45 Cat. 6 FTP retractable cord on the user side and - 1 x RJ 45 socket on the installation side Patch cord for connection to data network to be ordered separately | 3050 | 1 |
|---------|--|------|---|



0540 65

USB / micro USB

| | | | |
|---------|--|------|---|
| 0540 67 | Equipped with - 1.35 m retractable cord with micro USB connector, on the user side and - 0.5 m cable with USB connector on the installation side | 2764 | 1 |
|---------|--|------|---|



0540 67

Finishing plates for empty power & data desk grommets

For fitting on an empty power & data desk grommets

| | | | |
|---------|-----------------|------|----|
| 0540 60 | White RAL 9003 | 302 | 10 |
| 0540 62 | Black RAL 9017 | 332 | 10 |
| 0540 63 | Stainless steel | 1210 | 10 |



0540 60



0540 62

Cable worm

| | | | |
|---------|---|------|---|
| 0535 98 | 2 compartments, Length: 0.75 m White colour very suitable solution for a safe and design protection of the cabling between desk and floor | 4774 | 1 |
|---------|---|------|---|



0535 98

Flush mounting power and data module

A ready to embed solution for all dry support with thickness between 2 and 40 mm. Conform to standard NFC 61-314 which ensures safety of the user

Aesthetic product (no visible screw), thickness of 6mm only.

Product available in 8 and 12 module, with the option of configuring power sockets, data, AV, protection etc. 3 Finishes; white/ black and aluminium

Flush mounting power and data module to be equipped

Aluminium extensions with cable guide (reversible)

To be equipped with Arteor sockets

8 module; length - 180 mm

| | | | |
|---------|------------------------------|------|---|
| 0535 60 | Flush 8 mod white finish | 5452 | 1 |
| 0535 61 | Flush 8 mod aluminium finish | 6430 | 1 |
| 0535 62 | Flush 8 mod black finish | 5308 | 1 |



0535 60

12 module; length - 270 mm

| | | | |
|---------|-------------------------------|------|---|
| 0535 63 | Flush 12 mod white finish | 5734 | 1 |
| 0535 64 | Flush 12 mod aluminium finish | 6910 | 1 |
| 0535 65 | Flush 12 mod black finish | 5786 | 1 |

* MRP - Maximum Retail Price Inclusive of all taxes including GST.

* Finishing Plates to be ordered separately

Red Cat.Nos - new products

Bold Cat.Nos are products normally available with Legrand (India) Stockists. Cat.Nos that are not bold - delivery within 4 - 8 weeks from the date of order. Bold packing quantity is our mandatory packing. Orders to be placed by Legrand (India) Stockist in multiples of the same.

DLP-S

UNIVERSAL TRUNKING

FOR THE ESSENTIALS

- Traditional installation method with modular or with universal supports
- Compatible with all types of 45 mm mechanisms (like Arteor)

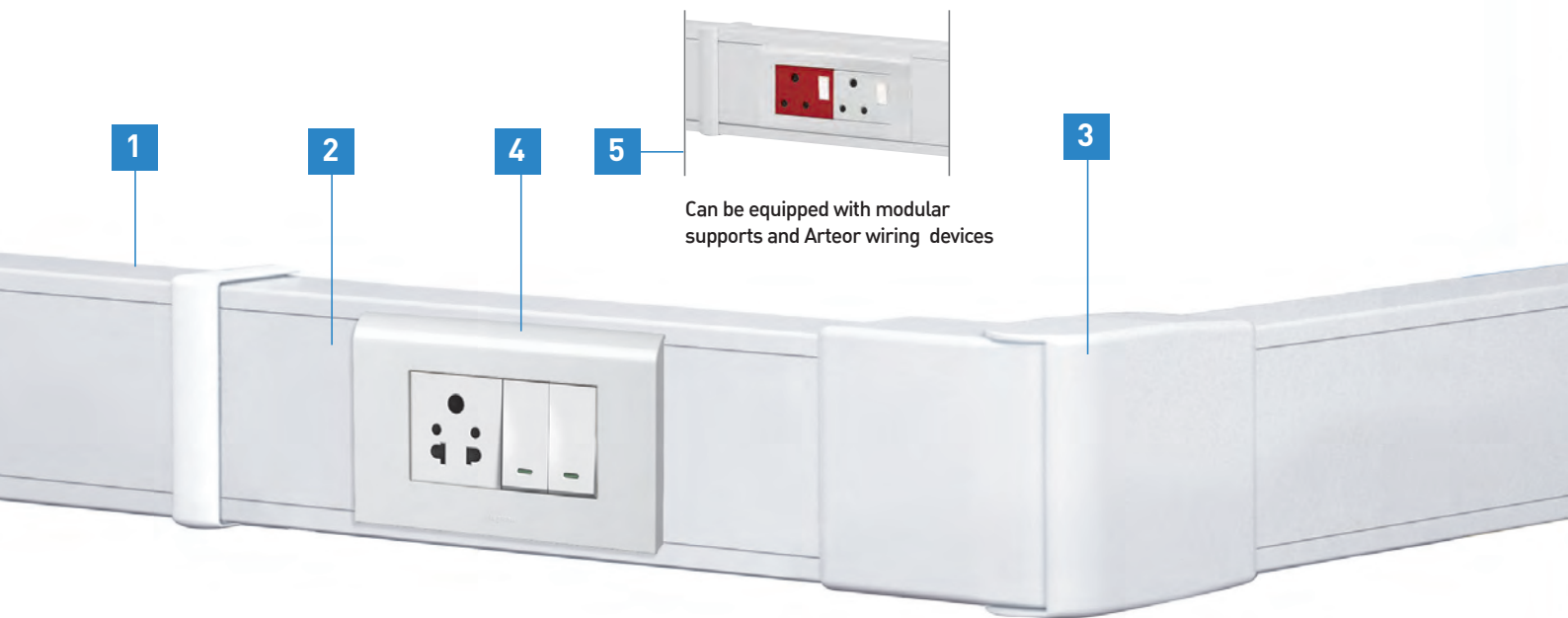

1 Rigid profiles with perforations

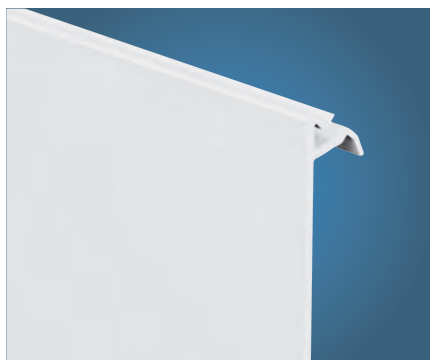

2 Self-guiding cover

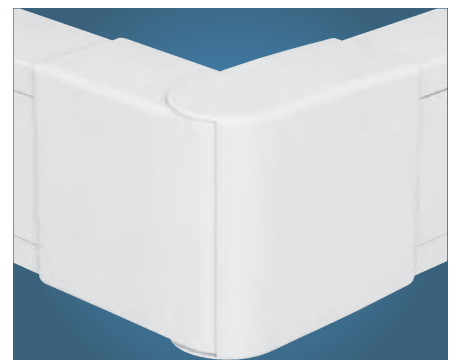

3 Ready to install accessories



4 Myrius single module switch with brackets

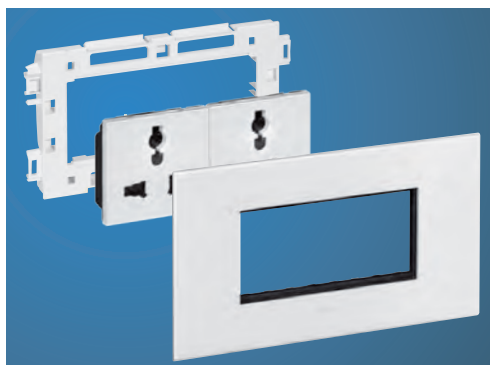

5 Arteor sockets and modular support

snap-on trunking

routing sections and accessories

| TRUNKING | | | TRUNKING | | |
|---|-------------|--------------------|---|---------|----------------------|
| Number of compartments | Cover width | Cross-section (mm) | Monobloc: body + cover ¹⁾ | Divider | Fishplate body joint |
| SNAP-ON TRUNKING - 45 mm cover | | | | | |
| | | 50 x 80 | ○ 0756 01 | 0756 09 | 0756 61 |
| | | 50 x 105 | 0756 02 | 0756 09 | 0756 62 |
| | | 50 x 130 | ○ 0756 03 | - | 0756 61 |
| | | 50 x 145 | 0756 04 | - | 0756 63 |
| | | 50 x 180 | 0756 06 | - | 0756 61 |
| <p>1: Partition(s) integral to the body 2: Internal and external corner angles supplied with multi-compartment partition joint</p> | | | | | |

mechanisms for snap-on trunking

| Mounting functions | | |
|---|--|---------|
| The Arteor sockets to be fitted with Soluclip accessory which has following features: - Anti-slip - Anti-pullout - IP 4X - Perfect finish | | 0756 90 |

Installation principle for sockets for snap-on trunking

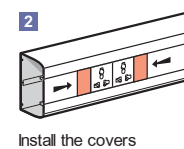
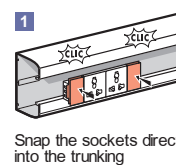

Installation principle for Arteor functions

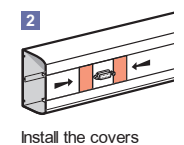
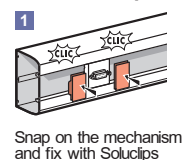

| AND ACCESSORIES | | | ANGLES | | | JUNCTIONS | | | | ACCESSORIES |
|-----------------------------|-------------|---------|--------------------------------|-----------------|-------------|---------------------------------|----------------------------------|--------------------------------|---|-------------|
| Stick-on body joint | Cover joint | End cap | Internal angles ⁽²⁾ | External angles | Flat angles | Flat junctions with width 80 mm | Flat junctions with width 105 mm | Angled junctions 85/105/130 mm | Junction with floor duct 50 x 12/ 92 x 20 | Extra cover |
| | | | | | | | | | | |
| 0756 66 | 0756 69 | 0756 11 | 0756 21 | 0756 31 | 0756 41 | 0756 71 | - | 0756 81 + 0756 21 | 0756 88 | 0756 08 |
| 0756 67 | 0756 69 | 0756 12 | 0756 22 | 0756 32 | 0756 42 | 0756 72 | 0756 76 | 0756 81 + 0756 22 | 0756 88 | 0756 08 |
| 0756 66 | 2 x 0756 69 | 0756 13 | 0756 23 | 0756 33 | 0756 43 | 0756 71 | 0756 75 | 0756 81 + 0756 23 | 0756 88 | 0756 08 |
| ① 0756 66 + ② 0756 67 | 2 x 0756 69 | 0756 14 | 0756 24 | 0756 34 | 0756 44 | ① 0756 71 + ② 0756 72 | ① 0756 75 + ② 0756 76 | 0756 81 + 0756 24 | 0756 88 | 0756 08 |
| 0756 66 | 3 x 0756 69 | 0756 16 | 0756 26 | 0756 36 | 0756 46 | 0756 71 | 0756 75 | 0756 81 + 0756 26 | 0756 88 | 0756 08 |

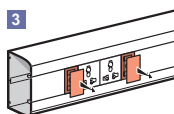

3 Disengage the finishing piece

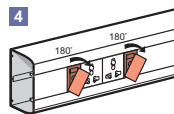

4 Rotate the finishing piece by 180°

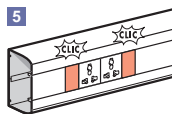

5 Snap on the finishing piece

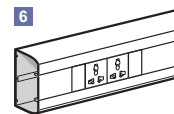

6 An impeccable result

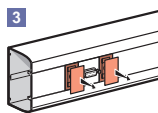

3 Disengage the finishing piece

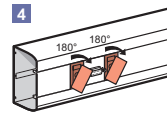

4 Rotate the finishing piece by 180°

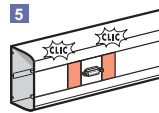

5 Snap on the finishing piece

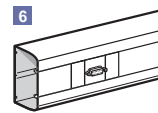

6 An impeccable result

DLP PVC adaptable trunking systems for installations base, covers, partitions, finishing accessories and mounting wiring accessories

Selection chart for Installation of trunking, Accessories and Arteor™

| Trunking | | | Covers | | Clip on partition | | Arteor™ frames | | | | |
|------------------------|----------------|-----------------|-------------------------|-----------------------|-------------------|-------------|----------------|----------|----------|----------|----------|
| Number of compartments | Cover(s) width | Section (mm) | | | | | | | | | |
| | | | Flexible | Partitions separation | Plastic | Aluminium | 1 module | 2 module | 3 module | 4 module | 6 module |
| 0104 12 | 1 | 80 x 50 | 0105 21 | 0105 82 | - | - | - | 0109 52 | 0109 31 | 0109 54 | 0109 56 |
| | 2 | | 0105 20 | 0105 82 | 0104 72 | 0111 06 | 0109 10 | - | - | - | - |
| 0104 22 | 1 | 105 x 50 | 0105 22 | 0105 82 | - | - | - | 0109 92 | 0109 93 | 0109 94 | 0109 96 |
| | 2 | | 0105 20 | 0105 82 | 0104 72 | 0111 06 | 0109 10 | - | - | - | - |
| | 2 | | 0105 20 + 0105 22 | 0105 82 | 0104 72 | 0111 06 | 0109 10 | 0109 92 | 0109 93 | 0109 94 | 0109 96 |
| | 3 | | 0105 20 | 0105 82 | 0104 72 x 2 | 0111 06 x 2 | 0109 10 | - | - | - | - |
| 0104 32 | 1 | 150 x 50 | 0105 24 | 0105 82 | - | - | - | - | - | - | - |
| | 2 | | 0105 21 | 0105 82 | 0104 72 | 0111 06 | - | 0109 52 | 0109 31 | 0109 54 | 0109 56 |
| | 2 | | 0105 20 + 0105 22 | 0105 82 | 0104 72 | 0111 06 | 0109 10 | 0109 92 | 0109 93 | 0109 94 | 0109 96 |
| | 3 | | 0105 20 | 0105 82 | 0104 72 x 2 | 0111 06 x 2 | 0109 10 | - | - | - | - |
| | 1 | | 0105 26 | 0105 82 | - | - | - | - | - | - | - |
| | 2 | | 0105 22 | 0105 82 | 0104 72 | 0111 06 | - | 0109 92 | 0109 93 | 0109 94 | 0109 96 |
| 0104 52 | 2 | 195 x 50 | 0105 82 | 0104 72 | 0111 06 | 0109 10 | - | - | - | - | |
| | 3 | | 0105 82 | 0104 72 x 2 | 0111 06 x 2 | 0109 10 | 0109 92 | 0109 93 | 0109 94 | 0109 62 | |
| | 3 | | 0105 82 | 0104 72 x 2 | 0111 06 x 2 | 0109 10 | 0109 52 | 0109 31 | 0109 54 | 0109 56 | |
| | 4 | | 0105 20 | 0105 82 | 0104 72 x 3 | 0111 06 x 3 | 0109 10 | - | - | - | - |

Selection chart for Installation trunking, Accessories and Arteor™

| Section (mm) | Wall crossing | Capacity change | Partition junction | Cable tie base | Insulating unit for Arteor™ modules | Earth Link |
|---------------------|-------------------|---|------------------------|--------------------|---|------------|
| | | | | | | |
| 80 x 50 / 105 x 50 | 0106 98 | 0106 87 + 0106 88 + 0106 89 (to be used for partition) | 0106 89 | 0308 81 | 2 Module Combined to get 4/6 Module | 0111 88 |
| 150 x 50 / 195 x 50 | 0106 99 | | | | | |

Selection chart for Installation of trunking, Additional accessories

| Cover | Bases | | Internal angles 80° - 100° | | | External angles 60° - 120° | | | Flat angles | | Flat junction | | | |
|------------------|------------|----------|----------------------------|--------------------|-------------|----------------------------|--------------------|-------------|-------------|-------------|---------------|--------------------|-------------|---------|
| | | | | | | | | | | | | | | |
| Joint for covers | Base joint | End caps | Angles | Partition junction | VDI access. | Angles | Partition junction | VDI access. | Angles | VDI access. | Angles | Partition junction | VDI access. | Clips |
| 0108 01 | 0106 91 | 0107 22 | 0106 02 | - | 0107 80 | 0106 22 | - | 0107 81 | 0107 67 | 0107 82 | 0107 32 | - | 0107 83 | 0106 82 |
| 0108 02 | 0106 91 | 0107 02 | 0106 02 | - | 0107 80 | 0106 22 | - | 0107 81 | 0107 85 | 0107 82 | 0107 32 | - | 0107 83 | 0106 82 |
| 0108 00 | 0106 91 | 0107 02 | 0106 02 | 0106 11 | - | 0106 22 | 0106 32 | - | - | - | 0107 32 | 0107 42 | - | 0106 82 |
| 0108 04 | 0106 91 | 0107 06 | 0106 02 | - | - | 0106 22 | - | - | 0107 89 | - | 0107 32 | - | - | 0106 86 |
| 0108 01 | 0106 91 | 0107 06 | 0106 02 | 0106 11 | 0107 80 | 0106 22 | 0106 32 | 0107 81 | 0107 89 | 0107 82 | 0107 32 | 0107 42 | 0107 83 | 0106 82 |
| 0108 02 | 0106 91 | 0107 06 | 0106 02 | 0106 11 | 0107 80 | 0106 22 | 0106 32 | 0107 81 | 0107 89 | 0107 82 | 0107 32 | 0107 42 | 0107 83 | 0106 82 |
| 0108 00 | 0106 91 | 0107 06 | 0106 02 | 0106 11 x2 | - | 0106 22 | 0106 32 x2 | - | 0107 89 | - | 0107 32 | 0107 42 | - | 0106 82 |
| 0108 06 | 0106 91 | 0107 07 | 0106 02 | - | - | 0106 22 | - | - | 0107 92 | - | 0107 32 | - | - | 0106 86 |
| 0108 02 | 0106 91 | 0107 07 | 0106 02 | 0106 11 | 0107 80 | 0106 22 | 0106 32 | 0107 81 | 0107 92 | 0107 82 | 0107 32 | 0107 42 | 0107 83 | 0106 82 |
| | 0106 91 | 0107 07 | 0106 02 | 0106 11 | 0107 80 | 0106 22 | 0106 32 | 0107 81 | 0107 92 | 0107 82 | 0107 32 | 0107 42 | 0107 83 | |
| | 0106 91 | 0107 07 | 0106 02 | 0106 11 x2 | 0107 80 | 0106 22 | 0106 32 x2 | 0107 81 | 0107 92 | 0107 82 | 010732 | 0107 42 | 0107 83 | 0106 82 |
| | 0106 91 | 0107 07 | 0106 02 | 0106 11 x2 | 0107 80 | 0106 22 | 0106 32 x2 | 0107 81 | 0107 92 | 010782 | 0107 32 | 0107 42 | 010783 | 0106 82 |
| 0108 00 | 0106 91 | 0107 07 | 0106 02 | 0106 11 x3 | - | 0106 22 | 0106 32 x3 | - | 0107 92 | - | 0107 32 | 0107 42 | - | 0106 82 |

DLP mini trunking systems for cable distribution







■ Selection chart for DLP mini trunking

| | Length | Finishing Accessories | | | | Junction Elements |
|-----------|---------|-----------------------|----------------|----------------|------------|-------------------|
| WHITE | 2 m | End cap | Internal angle | External angle | Flat angle | Flat junction |
| 32 x 12.5 | 0300 15 | 0312 03 | 0302 51 | 0302 51 | 0302 53 | 0302 54 |
| 32 x 16 | 0308 04 | 0312 07 | 0333 25 | 0333 25 | 0333 27 | 0333 30 |
| 32 x 20 | 0300 17 | 0312 09 | 0302 71 | 0302 71 | 0302 73 | 0302 74 |





DLP aluminium trunking system

selection chart of sections, covers and accessories
selection chart of support for wiring accessories

TRUNKING AND ACCESSORIES

| | | | | Rigid covers  | | | |  | Trunking  | | |
|------------|---|--------------|-----------|--|-------------|--------------|--------------|---|---|-------------|------------|
| Width (mm) | Nos. of compartments | Covers width | Cat. nos. | 65 mm width | 85 mm width | 130 mm width | 180 mm width | | | Cover Joint | Base Joint |
| 105 x 50 | 1  | 1 x 85 | 111 00 | - | 0111 11 | - | - | 0111 63 | 0111 66 | | |
| 150 x 50 | 2  | 2 x 65 | 0111 02 | 2 x 0111 10 | - | | - | 0111 62 | 0111 66 | | |
| 195 x 50 | 2  | 2 x 85 | 0111 04 | - | 2 x 0111 11 | - | - | 0111 63 | 0111 66 | | |

SUPPORT FOR WIRING ACCESSORIES

| 60 mm fixing centers : Arteur™ | Cover depths | |
|---|--------------|---------|
| No of module | 65 mm | 85 mm |
| 2 modules  | 0112 02 | 0112 12 |
| 3 modules  | 0112 03 | 0112 13 |
| 4 modules  | 0112 04 | 0112 14 |
| 6 modules  | 0112 06 | 0112 16 |

Insulation resistance : the entire DLP range, including accessories, have insulation resistance above 5 Megaohms

DLP TRUNKING SYSTEM ALUMINIUM

with aluminium adaptable
DLP trunking,
get better styling too !



SELECTION CHART OF ACCESSORIES (continued)

| Dividers | | End cap | Internal angles | External angles | Flat angles | Junction Flat junction* | Clips | Earth link |
|-------------------|----------------------|---------|-----------------|-----------------|-------------|----------------------------|---------|------------|
| Clip-on partition | Separation partition | | | | | | | |
| - | 0111 08 | 0111 58 | 0112 21 | 0112 32 | 0112 43 | 0112 51 | 0106 82 | 0111 88 |
| 0111 06 | 0111 08 | 0111 60 | 0112 27 | 0112 38 | 0112 45 | 0112 51 | 0106 82 | 0111 88 |
| 0111 06 | 0111 08 | 0111 61 | 0112 29 | 0112 40 | 0112 47 | 0112 51 | 0106 82 | 0111 88 |

(1) To be used with angle covers. (2) To be used with rigid covers

TABLE OF CAPACITIES

| | Crosssection (mm ²) Max. Ø (mm ²) | 105 x 50 | 150 x 50 | | 195 x 50 | |
|-----------------------|--|----------|----------|----------|----------|----------|
| | | cover 85 | cover 65 | cover 65 | cover 85 | cover 85 |
| Trunking only | Cross-section | 4330 | 3020 | 3020 | 5350 | 5350 |
| | Max. Ø | 28 | 43 | 43 | 55 | 55 |
| With Arteor / support | Cross-section | 2300 | 1470 | 1470 | 3320 | 3320 |
| | Max. Ø | 2 x 24 | 18 | 18 | 33 | 33 |

*To tap off 105 mm wide trunking with 85 mm cover

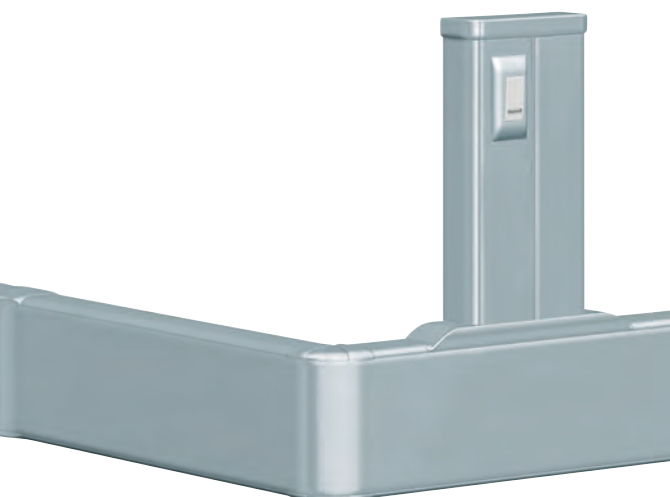

SAVE TIME

- Flexibility : multi-covers
- Removable separation
- Angles delivered pre-cut, ready to use
- Fast fixing device support
- Uniform colours for the entire installation
- Arteor™ wiring accessories go with aluminium adaptable DLP trunking

Snap-on trunking routing sections and accessories

Snap-on trunking routing sections and accessories

| Cat.Nos | Description | MRP* ₹ / Unit | Pack |
|---|--|------------------|-------------------|
| Snap-on trunking | | | |
| Monobloc: Body + Cover, can take any Arteor wiring accessory | | | |
| 0756 01 | Snap-on trunking 50 x 80 1 - compartment | 938 | 20 ⁽¹⁾ |
| 0756 02 | Snap-on trunking 50 x 105 1 - compartment | 1192 | 12 ⁽¹⁾ |
| 0756 03 | Snap-on trunking 50 x 130 2 - compartments | 1642 | 12 ⁽¹⁾ |
| 0756 04 | Snap-on trunking 50 x 145 2 - compartments | 2116 | 8 ⁽¹⁾ |
| 0756 06 | Snap-on trunking 50 x 180 3 - compartments | 2332 | 8 ⁽¹⁾ |
| Divider | | | |
| 0756 09 | Divider | 202 | 26 ⁽¹⁾ |
| Extra cover | | | |
| 0756 08 | Width 45 mm | 362 | 20 ⁽¹⁾ |
| Joints | | | |
| Fishplate Body joint | | | |
| 0756 61 | Set of 2 Body joints | 328 | 10 |
| 0756 62 | Set of 2 Body joints | 434 | 10 |
| 0756 63 | Set of 2 Body joints | 380 | 10 |
| Stick-on body joint | | | |
| 0756 66 | For top part of body | 212 | 20 |
| 0756 67 | For bottom part of body | 254 | 20 |
| Cover joint | | | |
| 0756 69 | Cover joint, width 45 mm | 114 | 10 |
| End caps | | | |
| 0756 11 | Left or right end cap | 188 | 10 |
| 0756 12 | Left or right end cap | 188 | 10 |
| 0756 13 | Left or right end cap | 310 | 5 |
| 0756 14 | Left or right end cap | 324 | 5 |
| 0756 16 | Left or right end cap | 354 | 5 |
| Height spacer | | | |
| 0105 80 | Colour charcoal grey for fitting 15 mm from the ground | 474 | 24 ⁽¹⁾ |
| Soluclip accessory | | | |
| Fishplate body joint | | | |
| 0756 90 | For installation with any Arteor function | 162 | 10 |
| Angles | | | |
| Internal angles | | | |
| 0756 21 | varies from 80° to 100° | 434 | 10 |
| 0756 22 | varies from 80° to 100° | 604 | 10 |
| 0756 23 | varies from 80° to 100° | 1016 | 5 |
| 0756 24 | varies from 80° to 100° | 1632 | 5 |
| 0756 26 | varies from 80° to 100° | 1442 | 5 |
| External angles | | | |
| 0756 31 | varies from 85° to 120° | 904 | 10 |
| 0756 32 | varies from 85° to 120° | 1384 | 10 |
| 0756 33 | varies from 85° to 120° | 1878 | 5 |
| 0756 34 | varies from 85° to 120° | 2212 | 5 |
| 0756 36 | varies from 85° to 120° | 2624 | 5 |
| Flat angles | | | |
| 0756 41 | Flat angle at 90° | 528 | 10 |
| 0756 42 | Flat angle at 90° | 694 | 10 |
| 0756 43 | Flat angle at 90° | 1384 | 5 |
| 0756 44 | Flat angle at 90° | 1296 | 5 |
| 0756 46 | Flat angle at 90° | 2592 | 5 |

| Cat.Nos | Description | MRP* ₹ / Unit | Pack |
|--|--|------------------|-------------------|
| Junctions | | | |
| Flat junctions with 80 mm width | | | |
| 0756 71 | Creates a junction | 726 | 5 |
| 0756 72 | Creates a junction | 726 | 5 |
| For 105 mm wide upward trunking | | | |
| 0756 75 | Creates a junction | 710 | 5 |
| 0756 76 | Creates a junction | 776 | 5 |
| Angled junction | | | |
| Must be used in conjunction with an internal angle | | | |
| 0756 81 | Creates a junction in an internal angle | 1598 | 5 |
| Junction with floor duct | | | |
| 0756 88 | Creates a junction with a floor duct size 50 x 12 mm or 92 x 20 mm | 838 | 5 |
| DLP PVC trunking system | | | |
| Mini-trunking system | | | |
| Mini-trunking - 32 x 12.5 mm | | | |
| 0300 15 | Without central partition | 104 | 80 ⁽¹⁾ |
| Finishing accessories | | | |
| 0312 03 | End cap right or left | 54 | 20/400 |
| 0302 51 | Changeable internal - external angle from 60° to 120° | 76 | 10/100 |
| 0302 53 | Changeable flat angle from 85° to 95° | 84 | 10/100 |
| 0302 54 | Flat junction | 108 | 10/200 |
| 0336 03 | White 32 x 10/12.5 Cover Joint | 106 | 20 |
| Mini-trunking - 32 x 16 mm | | | |
| 0308 04 | Without central partition | 134 | 60 ⁽¹⁾ |
| Finishing accessories | | | |
| 0312 07 | End cap right or left | 82 | 10 |
| 0333 25 | Changeable internal - external angle from 60° to 120° | 92 | 10 |
| 0333 27 | Changeable flat angle from 85° to 95° | 90 | 10 |
| 0333 30 | Flat junction | 126 | 10 |
| 0336 04 | White 32 x 16/20 Cover Joint | 106 | 20 |
| Mini-trunking - 32 x 20 mm | | | |
| 0300 17 | Without partition | 144 | 50 ⁽¹⁾ |
| Finishing accessories | | | |
| 0312 09 | End cap right or left | 114 | 10 |
| 0302 71 | Changeable internal - external angle from 60° to 120° | 108 | 10 |
| 0302 73 | Changeable flat angle from 85° to 95° | 92 | 10 |
| 0302 74 | Flat junction | 106 | 10 |
| 0336 04 | White 32 x 16/20 Cover Joint | 106 | 20 |

* MRP - Maximum Retail Price Inclusive of all taxes including GST.
(1) Price in Meters; No of meters in Pack, Standard length 2 meters to be ordered in multiples of 2 meters

Bold Cat.Nos are products normally available with Legrand (India) Stockists. Cat.Nos that are not bold - delivery within 4 - 8 weeks from the date of order. Bold packing quantity is our mandatory packing. Orders to be placed by Legrand (India) Stockist in multiples of the same.

DLP PVC trunking system and accessories - trunking and fittings

| Cat.Nos | Description | MRP* ₹ / Unit | Pack |
|---------|-------------|------------------|------|
|---------|-------------|------------------|------|

Trunking

Bodies

Supplied without cover

| | | | |
|---------|-------------|------|-------------------|
| 0104 12 | 80 x 50 mm | 592 | 20 ⁽¹⁾ |
| 0104 22 | 105 x 50 mm | 736 | 20 ⁽¹⁾ |
| 0104 32 | 150 x 50 mm | 1246 | 10 ⁽¹⁾ |
| 0104 52 | 195 x 50 mm | 1650 | 8 ⁽¹⁾ |

Flexible cover

Fits onto the whole branch including in internal or external angles

| | | | |
|---------|-------------------------|-----|-------------------|
| 0105 20 | Full covers width 40 mm | 290 | 20 ⁽¹⁾ |
| 0105 21 | Full cover width 65 mm | 284 | 24 ⁽¹⁾ |
| 0105 22 | Full cover width 85 mm | 330 | 20 ⁽¹⁾ |
| 0105 24 | Full cover width 130 mm | 694 | 8 |
| 0105 26 | Full cover width 180 mm | 884 | 8 ⁽¹⁾ |

Partitions

| | | | |
|---------|-------------------------------|------|-------------------|
| 0105 82 | Separation partition | 192 | 24 ⁽¹⁾ |
| 0104 72 | Clip-on partition - Plastic | 284 | 48 ⁽¹⁾ |
| 0111 06 | Clip-on partition - Aluminium | 1140 | 12 ⁽¹⁾ |

Joints

| | | | |
|---------|--|-----|--------|
| 0106 91 | Body / Base joint - For aligning bases during installation | 66 | 20/200 |
| 0108 00 | Cover joint for 40 mm width | 134 | 10/100 |
| 0108 01 | Cover joint for 65 mm width | 114 | 10/100 |
| 0108 02 | Cover joint for 85 mm width | 174 | 10/100 |
| 0108 04 | Cover joint for 130 mm width | 292 | 10/100 |
| 0108 06 | Cover joint for 180 mm width | 270 | 10/100 |

Angles and end caps

Internal and external angles

Include the 2 components for the top and bottom of the trunking on which the flexible cover is fitted

| | | | |
|---------|---|-----|-------|
| 0106 02 | Internal angle, adjustable from 80° to 100° | 418 | 10/40 |
| 0106 22 | External angle, adjustable from 60° to 120° | 408 | 10/50 |

Flat angle

| | | | |
|---------|----------------|------|----|
| 0107 67 | 90° flat angle | 576 | 10 |
| 0107 85 | 90° flat angle | 604 | 10 |
| 0107 89 | 90° flat angle | 2002 | 5 |
| 0107 92 | 90° flat angle | 2568 | 2 |

End cap

| | | | |
|---------|-----------------------|-----|--------|
| 0107 02 | Left or right end cap | 150 | 20/100 |
| 0107 06 | Left or right end cap | 290 | 10/50 |
| 0107 07 | Left or right end cap | 344 | 5/50 |
| 0107 22 | Left or right end cap | 162 | 10 |

Junctions

| | | | |
|---------|---|-----|------|
| 0107 32 | Flat junctions to tap-off to a branch smaller than 50 x 105 | 748 | 10 |
| 0107 35 | For specific size tap-off to 80 mm wide branch | 436 | 5 |
| 0107 36 | For tap-off to an 105 mm wide branch equipped with an 85 mm cover | 432 | 5/25 |
| 0107 37 | Flat junction for specific size - tap off to an 105 mm wide branch with 65 mm cover | 432 | 5/25 |

* MRP - Maximum Retail Price Inclusive of all taxes including GST.
(1) Price in Meters; No of meters in Pack, Standard length 2 meters to be ordered in multiples of 2 meters

DLP PVC trunking system and accessories - trunking and fittings

| Cat.Nos | Description | MRP* ₹ / Unit | Pack |
|---------|-------------|------------------|------|
|---------|-------------|------------------|------|

Junctions

Partition junction

| | | | |
|---------|---------------------|-----|------|
| 0106 11 | For internal angles | 250 | 5/50 |
| 0106 32 | For external angles | 380 | 5/50 |
| 0107 42 | For flat angles | 896 | 5/25 |

Accessories

Holding cables in place

| | | | |
|---------|-----------------------------|-----|----|
| 0106 82 | Clip for 65 mm width cover | 58 | 50 |
| 0106 86 | Clip for 130 mm width cover | 100 | 50 |

VDI accessories

| | | | |
|---------|---------------------|-----|------|
| 0107 80 | For internal angles | 646 | 5/50 |
| 0107 81 | For external angles | 696 | 5/50 |
| 0107 82 | For flat angles | 740 | 5/50 |
| 0107 83 | For flat junctions | 892 | 5/50 |

Additional accessories

| | | | |
|---------|---|-----|----------|
| 0106 98 | Wall crossing for trunking 80 to 150 mm width | 718 | 5/25 |
| 0106 99 | Wall crossing for trunking 195 mm width | 746 | 5/25 |
| 0308 81 | Cable tie base | 24 | 100/1000 |
| 0111 88 | Earthing link | 276 | 20/500 |

Capacity Change

Allows to increase 15 mm height of trunking to preserve the space of wiring with a flat junction or a support equipment

| | | | |
|---------|---|-----|--------|
| 0106 87 | Raise, length 57 cm | 258 | 40 |
| 0106 88 | Set of 4 accessories to change capacity of the body | 326 | 10/100 |
| 0106 89 | Set of 2 accessories to change height of partition (to be used) | 328 | 5/50 |

Supports for mounting wiring accessories

Arteor™ supports

Clip-on supports which can be fitted side by side
Supplied with finishing plate

| | | | |
|---------|--|-----|--------|
| 0109 10 | 1 modules-for 40 mm cover | 148 | 5/50 |
| 0109 52 | 2 modules-for 65 mm cover | 146 | 20 |
| 0109 92 | 2 modules-for 85 mm cover | 152 | 20 |
| 0109 31 | 3 modules-for 65 mm cover | 196 | 5/50 |
| 0109 93 | 3 modules-for 85 mm cover | 210 | 5/50 |
| 0109 54 | 4 modules-for 65 mm cover | 222 | 10/50 |
| 0109 94 | 4 modules-for 85 mm cover | 232 | 20 |
| 0109 56 | 6 modules-for 65 mm cover | 240 | 5/25 |
| 0109 96 | 6 modules-for 85 mm cover | 294 | 10 |
| 0109 27 | Insulation unit for 2 modules (Arteor™) can be fitted together to create 4/6/8 module supports | 252 | 10/100 |

Legrand Lexic supports

| | | | |
|---------|--|------|---|
| 0109 25 | For 2 modules for 65 mm cover (2 comp.) | 880 | 5 |
| 0109 35 | For 3 modules for 85 mm cover (2 comp.) | 1042 | 5 |
| 0109 65 | For 6 modules for 130 mm cover (1 comp.) | 1168 | 5 |
| 0109 00 | Hypra socket support - for 130 mm cover | 1692 | 5 |

Bold Cat.Nos are products normally available with Legrand (India) Stockists. Cat.Nos that are not bold - delivery within 4 - 8 weeks from the date of order. Bold packing quantity is our mandatory packing. Orders to be placed by Legrand (India) Stockist in multiples of the same.

DLP-S PVC trunking system and accessories - trunking and fittings

| Cat.Nos | Description | MRP* ₹ / Unit | Pack |
|---------|-------------|------------------|------|
|---------|-------------|------------------|------|

Trunking

Body with cover

| | | | |
|---------|----------|-----|-------------------|
| 6380 38 | 100 x 50 | 848 | 12 ⁽¹⁾ |
|---------|----------|-----|-------------------|

Partition

| | | | |
|---------|----------------------|-----|-------------------|
| 6380 08 | Separation Partition | 154 | 32 ⁽¹⁾ |
|---------|----------------------|-----|-------------------|

Joints

| | | | |
|---------|-------------------|-----|----|
| 6380 36 | Body / Base Joint | 52 | 10 |
| 6380 01 | Cover joint | 140 | 50 |

Angles and end caps

Variable angles

| | | | |
|---------|-------------------------|-----|----|
| 6380 31 | Variable Internal Angle | 326 | 10 |
| 6380 32 | Variable External Angle | 326 | 10 |

Fixed angles

| | | | |
|---------|----------------------|-----|----|
| 6380 11 | Fixed Internal Angle | 210 | 20 |
| 6380 12 | Fixed External Angle | 212 | 20 |

Flat angle

| | | | |
|---------|------------|-----|----|
| 6380 13 | Flat Angle | 462 | 16 |
|---------|------------|-----|----|

End cap

| | | | |
|---------|---------|-----|----|
| 6380 35 | End Cap | 120 | 20 |
|---------|---------|-----|----|

Bracket

| | | | |
|---------|--------------------------------------|-----|--------|
| 6380 05 | Universal Bracket (set of 2 pcs.) | 104 | 10/100 |
|---------|--------------------------------------|-----|--------|

Junction

| | | | |
|---------|---------------------|------|---|
| 6380 34 | Tee / Flat Junction | 1020 | 5 |
|---------|---------------------|------|---|

Supports for mounting wiring accessories

Arteor™ & Myrius supports

Clip-on supports which can be fitted side by side
Supplied with finishing plate

| | | | |
|---------|-----------------|-----|----|
| 6380 71 | 2 modules frame | 146 | 10 |
| 6380 72 | 4 modules frame | 206 | 5 |
| 6380 73 | 6 modules frame | 298 | 5 |

DLP aluminium adaptable trunking system

Body

| | | | |
|---------|--|------|------------------|
| 0111 00 | 100 x 50 Supplied without cover | 3696 | 8 ⁽¹⁾ |
| 0111 02 | 150 x 50 Supplied without cover allow fitting of partial covers - 2 compartments | 4656 | 4 ⁽¹⁾ |
| 0111 04 | 195 x 50 Supplied without cover allow fitting of partial covers - 2 compartments | 5460 | 4 ⁽¹⁾ |

Cover and partition

| | | | |
|---------|-------------------------|------|-------------------|
| 0111 10 | Rigid cover 65 mm width | 92 | 16 ⁽¹⁾ |
| 0111 11 | Rigid cover 85 mm width | 1206 | 16 ⁽¹⁾ |
| 0111 08 | Separation partition | 636 | 24 ⁽¹⁾ |
| 0111 06 | Clip on Partition | 1140 | 12 ⁽¹⁾ |

Finishing accessories

| | | | |
|---------|---------------------|------|--------|
| 0111 66 | Base / Body joint | 218 | 20/100 |
| 0111 62 | Cover joint - 65 mm | 300 | 10 |
| 0111 63 | Cover joint - 85 mm | 318 | 10/100 |
| 0111 58 | End cap | 652 | 20/100 |
| 0111 60 | End cap | 1396 | 10 |
| 0111 61 | End cap | 1654 | 10 |

* MRP - Maximum Retail Price Inclusive of all taxes including GST.
(1) Price in Meters; No of meters in Pack, Standard length 2 meters to be ordered in multiples of 2 meters

DLP aluminium adaptable trunking system - trunking and fittings

| Cat.Nos | Description | MRP* ₹ / Unit | Pack |
|---------|-------------|------------------|------|
|---------|-------------|------------------|------|

Finishing accessories

| | | | |
|---------|--|-------|----|
| 0112 43 | Flat angle for 85 mm cover | 5608 | 10 |
| 0112 45 | Flat angle for cover 65/130 mm | 9444 | 5 |
| 0112 47 | Flat angle for cover 85/180 mm | 9740 | 2 |
| 0112 32 | External angle for 85 mm cover | 6994 | 1 |
| 0112 38 | External angle 2 cover 65 mm | 14480 | 1 |
| 0112 40 | External angle 2 covers 85mm | 15120 | 1 |
| 0112 21 | Internal angle for 85 mm cover | 6292 | 1 |
| 0112 27 | Internal angle 2 Covers 65 mm | 14374 | 1 |
| 0112 29 | Internal angle 2 Cover 85 mm | 15012 | 1 |
| 0112 51 | Flat junction To tap off to 105 mm wide trunking equipped with 85 mm cover | 7614 | 5 |

Supports for Arteor™ for cover 85 mm width

| | | | |
|---------|-----------|-----|----|
| 0112 12 | 2 modules | 456 | 20 |
| 0112 13 | 3 modules | 534 | 20 |
| 0112 14 | 4 modules | 536 | 20 |
| 0112 16 | 6 modules | 714 | 10 |

Supports for Arteor™ for cover 65 mm width

| | | | |
|---------|-----------|-----|----|
| 0112 02 | 2 modules | 414 | 20 |
| 0112 03 | 3 modules | 506 | 20 |
| 0112 04 | 4 modules | 526 | 20 |
| 0112 06 | 6 modules | 618 | 10 |

Cabling accessories

| | | | |
|---------|---------------------------------|-----|-----|
| 0106 82 | Clip for 65 mm and 85 mm covers | 58 | 50 |
| 0111 88 | Earth link | 276 | 20 |
| 0308 81 | Base for cable ties | 24 | 100 |

Aluminium Snap-on Columns 2 Compartments mini - columns

| | | | |
|---------|---|-------|---|
| | Can be equipped with ovaline kits Cat.Nos 6530 63/64/65 | | |
| 6530 23 | White finish PVC body and covers Height 0.68 m | 9724 | 1 |
| 6530 24 | Aluminium finish Aluminium body and covers Height 0.68 m | 13728 | 1 |

Accessories for 1 or 2 compartments mini- columns

| | | | |
|---------|-----------------------------------|-------|---|
| 6530 84 | Table - white finish | 26884 | 1 |
| 6530 86 | Movable foot - white finish | 17732 | 1 |
| 6530 87 | Movable foot - aluminum finish | 18648 | 1 |
| 6530 88 | Set of 4 wheels with cable holder | 12240 | 1 |

Bold Cat.Nos are products normally available with Legrand (India) Stockists. Cat.Nos that are not bold - delivery within 4 - 8 weeks from the date of order. Bold packing quantity is our mandatory packing. Orders to be placed by Legrand (India) Stockist in multiples of the same.

Accessories for 1 or 2 compartments

| Cat.Nos | Description | MRP* ₹ / Unit | Pack |
|---------|-------------|------------------|------|
|---------|-------------|------------------|------|

Fixing clip

| | | | |
|---------|---|-----|----|
| 6038 57 | Fixing clip - Signal White (Set of 2 pcs.) | 206 | 10 |
| 6038 58 | Fixing clip -Grey/Anthracite (Set of 2 pcs.) | 582 | 10 |

1 Compartment - 2 sides columns

White finish

| | | | |
|---------|---|-------|---|
| 6530 10 | Aluminium body, PVC covers Height 2.70m Can be adapted to a ceiling Height upto 3.9m | 25512 | 1 |
| 6530 13 | Height 3.9m Can be adapted to a ceiling Height upto 5.1m Aluminium body and covers | 32832 | 1 |

Aluminium finish

| | | | |
|---------|---|-------|---|
| 6530 11 | Height 2.70m Can be adapted to a ceiling Height up to 3.9m Height 3.9m | 29744 | 1 |
| 6530 14 | Can be adapted to a ceiling height up to 5.1m | 37408 | 1 |

2 compartments columns

White finish

| | | | |
|---------|--|-------|---|
| 6530 30 | PVC body & covers Height 2.70m Can be adapted to a ceiling Height upto 3.9m | 24710 | 1 |
| 6530 33 | Height 3.9m Can be adapted to a ceiling Height up to 5.1m | 31918 | 1 |

Aluminium finish

| | | | |
|---------|--|-------|---|
| 6530 31 | Aluminium body and covers Height 2.70m Can be adapted to a ceiling Height up to 3.9m Height 3.9m | 33176 | 1 |
| 6530 34 | Can be adapted to a ceiling height up to 5.1m | 42900 | 1 |

Finishing kit for telescopic pole for 1 or 2 compartments columns

| | | | |
|---------|------------------------------------|------|---|
| | Consists of 2 PVC cover and a base | | |
| 6038 66 | White finish | 1716 | 1 |
| 6038 67 | Aluminium finish | 1830 | 1 |

Fixing clip

| | | | |
|---------|--|-----|----|
| 6038 57 | Fixing clip-Signal white (set of 2 pcs.) | 206 | 10 |
| 6038 58 | Fixing clip - Grey/Anthracite (Set of 2 pcs.) | 582 | 10 |

* MRP - Maximum Retail Price Inclusive of all taxes including GST.
(1) Price in Meters; No of meters in Pack, Standard length 2 meters to be ordered in multiples of 2 meters

www.legrand.co.in



Click to discover us

- 1 Legrand (India) - provides all information regarding the groups philosophy, products, organisation etc.
- 2 Products and solutions - complete information about our range of products for residential, commercial and industrial markets.
- 3 Downloads - download catalogues and brochures.

AUDIO/VIDEO PRETERMINATED SOCKETS

THE RIGHT SYSTEM TO MEET YOUR NEEDS

A wide range of technologies (HD15, HDMI, DISPLAY PORT, RCA, JACK) to suit the location and the user requirements

INSTALLATION EXAMPLE WITH HD15 PRETERMINATED SOCKET AND VIDEO PROJECTOR SWITCH

1 Quick
installation

2 Easy
connection

3 Optimum
performance

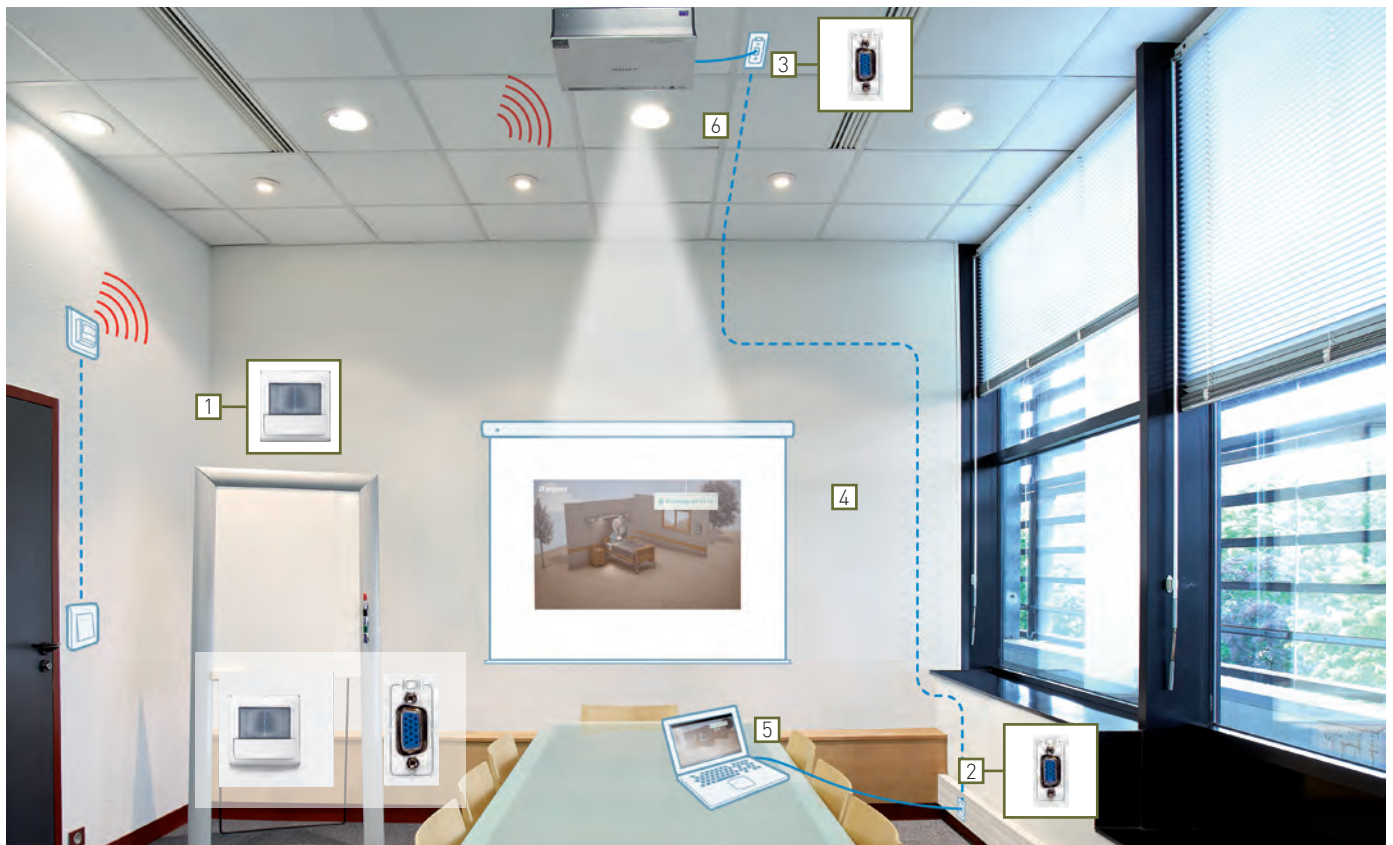

1 Infrared ON/STANDBY control for video projector associated with a pushbutton Cat.No 0 787 99/5 720 89

2 3 Preterminated HD15 sockets Cat.No 0 787 77/5 720 97

4 10 m male/male HD15 cords Cat.No 0 517 23

5 6 Male/male HD 15 cords

Legrand cabling system LCS³ category 8

| Cat.Nos | Description | MRP* ₹ / Unit | Pack |
|---------|-------------|------------------|------|
|---------|-------------|------------------|------|

Cat. 8 patch panel equipped with 24 RJ 45 connectors

Flat panel

| | | | |
|---------|-----------------------------|---|---|
| 0337 82 | STP panel - Metal shielding | ■ | 1 |
|---------|-----------------------------|---|---|



0337 82

Flat 24-connector patch panels - 1 U to be equipped

Flat panel with empty cassettes to be equipped with connectors

Equipped with 4 automatic extraction cassette for cat. 5e to cat. 8 RJ 45 connectors



0337 90

| | | | |
|---------|-----------------------|---|---|
| 0337 90 | 19" patch panel - 1 U | ■ | 1 |
|---------|-----------------------|---|---|

Empty flat panel to be equipped with cassette

It can accept a maximum of 4 automatic extraction cassettes:
- copper
- fibre optic

| | | | |
|---------|-----------------------|---|---|
| 0337 91 | 19" patch panel - 1 U | ■ | 1 |
|---------|-----------------------|---|---|

Angled 24-connector patch panel - 1 U

Angled panel to be equipped with connectors

It can accept up to 24 cat. 5e to cat. 8 RJ 45 connectors



0337 92

| | | | |
|---------|-----------------|---|--|
| 0337 92 | 19" panel - 1 U | ■ | |
|---------|-----------------|---|--|

Cat. 8 RJ 45 connectors for flat and angled STP panel

| | | | |
|---------|--|---|---|
| 0337 85 | Set of 6 RJ 45 connectors For installation in the cassettes of flat or angled panels | ■ | 1 |
|---------|--|---|---|

0337 85

Common accessories for flat and angled panels

Port blanking modules

| | | | |
|---------|--|---|----|
| 0337 56 | Divisible 6 port blanking plate for sealing from 1 to 6 ports | ■ | 10 |
|---------|--|---|----|



0337 56

Cord management

| | | | |
|---------|--|---|---|
| 0337 59 | 2 cord management for use with new generation Quick-Fix They provide side cord management | ■ | 1 |
|---------|--|---|---|

0337 59

Specific accessories for flat panels

Cassette for flat panels to be equipped

| | | | |
|---------|--|---|---|
| 0337 55 | Empty removable cassette to be equipped with connectors. It can accept 6 cat. 5e to cat. 8 connectors. Extraction by simple pressure of the cassette making installation and maintenance easier | ■ | 1 |
|---------|--|---|---|



0337 55

Blanking cassette

| | | | |
|---------|-------------------------|---|---|
| 0337 57 | Used to blank the panel | ■ | 1 |
|---------|-------------------------|---|---|



0337 57

Specific accessories for angled panels

Angled panel cover

| | | | |
|---------|--|---|---|
| 0337 58 | For optimised management of the air flow inside the cabinet | ■ | 1 |
|---------|--|---|---|



0337 58

* MRP - Maximum Retail Price Inclusive of all taxes including GST.
■ Price available on request.
(1) in meters

Legrand cabling system LCS³ category 8

| Cat.Nos | Description | MRP* ₹ / Unit | Pack |
|---------|-------------|------------------|------|
|---------|-------------|------------------|------|

Cat. 8 local network cables

F/UTP - 4 pairs

Performance 2000 MHz

| | | | |
|---------|--|---|------------------|
| 0337 86 | Length 500 m supplied on drum. Weight 42 kg | ■ | 500 ¹ |
|---------|--|---|------------------|



0337 88

S/FTP - 4 pairs

Performance 2000 MHz

| | | | |
|---------|--|---|------------------|
| 0337 88 | Length 500 m supplied on drum. Weight 45 kg | ■ | 500 ¹ |
|---------|--|---|------------------|



0337 03

Cat. 8 RJ 45 patch cords

S/FTP shielded, impedance 100 Ω

LSZH - RAL 6027

| | | | |
|---------|--------------|---|--|
| 0337 01 | Length 0.5 m | ■ | |
| 0337 02 | Length 1 m | ■ | |
| 0337 03 | Length 2 m | ■ | |
| 0337 04 | Length 3 m | ■ | |
| 0337 05 | Length 5 m | ■ | |
| 0337 06 | Length 8 m | ■ | |
| 0337 07 | Length 10 m | ■ | |

LSZH - RAL 3020

| | | | |
|---------|--------------|---|---|
| 0337 21 | Length 0.5 m | ■ | 1 |
| 0337 22 | Length 1 m | ■ | |
| 0337 23 | Length 2 m | ■ | |
| 0337 24 | Length 3 m | ■ | |
| 0337 25 | Length 5 m | ■ | |
| 0337 26 | Length 8 m | ■ | |
| 0337 27 | Length 10 m | ■ | 1 |

LSZH - RAL 6026

| | | | |
|---------|--------------|---|---|
| 0337 08 | Length 0.5 m | ■ | 1 |
| 0337 09 | Length 1 m | ■ | |
| 0337 10 | Length 2 m | ■ | |
| 0337 11 | Length 3 m | ■ | |
| 0337 12 | Length 5 m | ■ | |
| 0337 13 | Length 8 m | ■ | |
| 0337 17 | Length 10 m | ■ | 1 |

Marking kit

| | | | |
|---------|---|---|---|
| 0518 90 | Kit of 200 coloured rings for marking RJ 45 cords Rings to be clipped to the patch cords | ■ | 1 |
|---------|---|---|---|



0518 90

Legrand cabling system LCS³ category 6_A

Cat. 6_A patch panels equipped with 24 RJ 45 connectors

Flat panels

24 RJ 45 connectors - 1 U

| | | | |
|---------|-----|---|---|
| 0337 70 | UTP | ■ | 1 |
| 0337 72 | STP | ■ | 1 |



0337 72

Bold Cat.Nos are products normally available with Legrand (India) Stockists.
Cat.Nos that are not bold - delivery within 4 - 8 weeks from the date of order.
Bold packing quantity is our mandatory packing. Orders to be placed by
Legrand (India) Stockist in multiples of the same.

LCS³

FROM TECHNICAL ROOM TO WORKSTATION

Complete systems with a 20-year guarantee. The new LCS³ cat. 6a (up to 500 MHz), cat. 6 (up to 250 MHz) and cat. 5e (up to 100 MHz) systems have been designed as coherent entities to optimise their performance. The systems are suitable for optical fibre cables as well as copper cables.

The new LCS³ systems integrate perfectly in the various other Legrand solutions: DLP trunking system, cabling accessories, cable management, etc.

FIBRE OPTIC PANELS

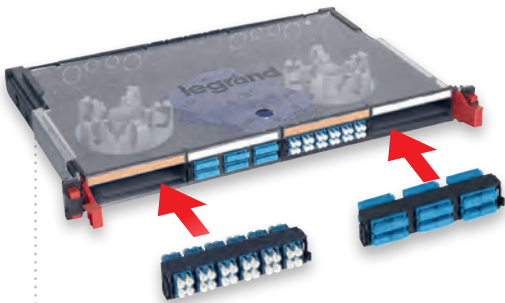

Modular panels



HD Modular panels

CORD LOCKING SYSTEM



AN INNOVATIVE TECHNICAL SOLUTION

FIBRE OPTIC SYSTEM

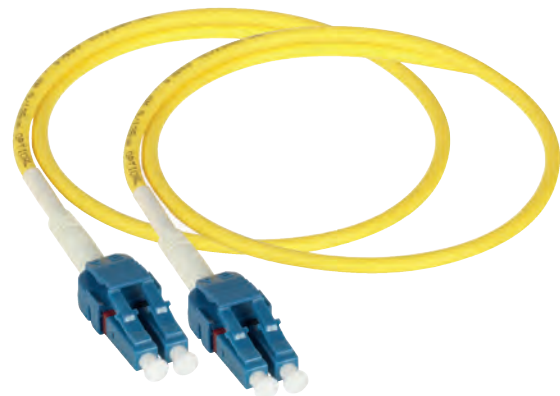

NEW TOOLLESS CONNECTOR CONNECTION PHASES

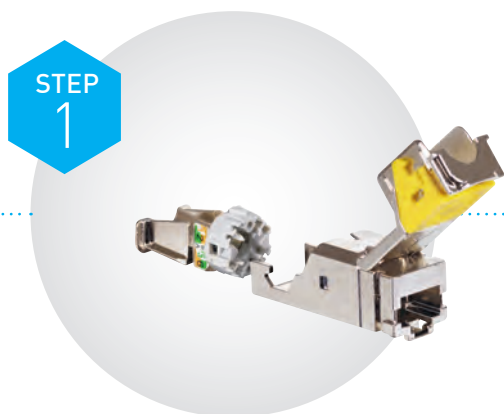

Take the wire housing

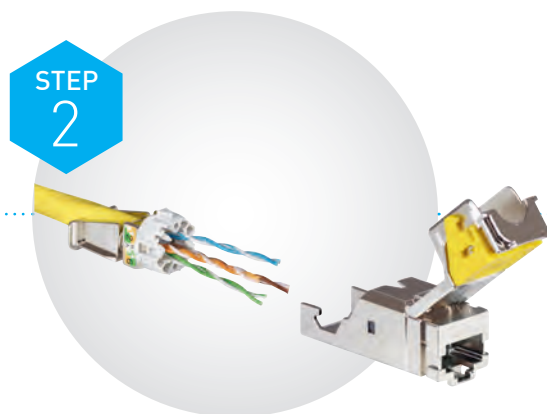

Pass the cable through the back of the wire housing

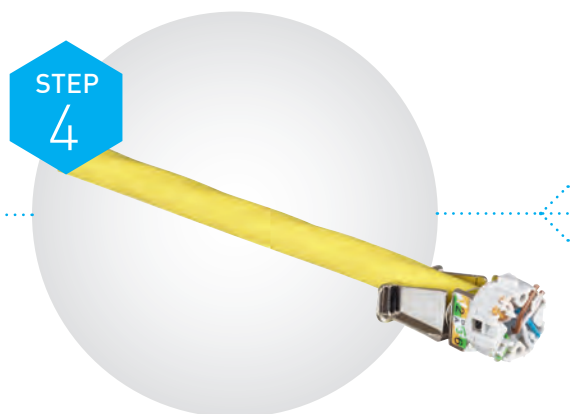

Cut the pairs

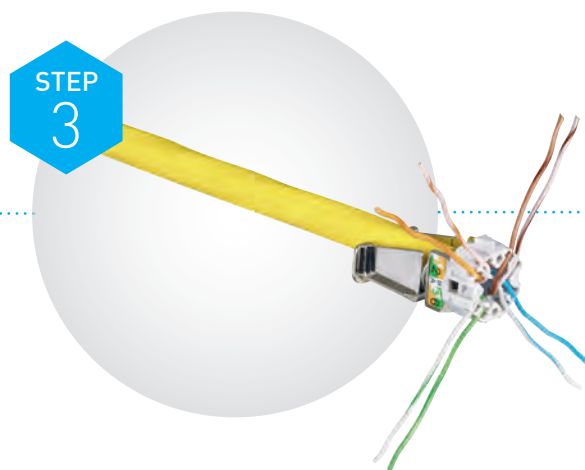

Separate and insert the pairs



Install the wire housing without pushing

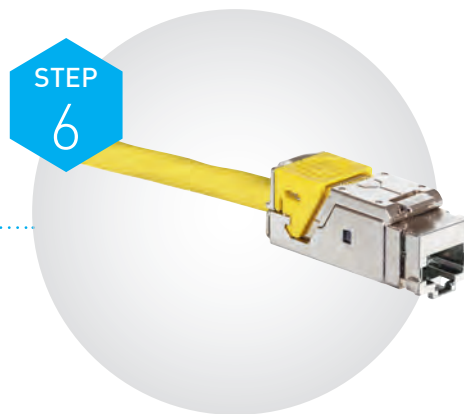

Push down the lever and lock the connector

Legrand cabling system LCS³ category 6_A

| Cat.Nos | Description | MRP* ₹ / Unit | Pack |
|---------|-------------|------------------|------|
|---------|-------------|------------------|------|

Flat 24-connector patch panels - 1 U to be equipped

Flat panel with empty cassettes to be equipped with connectors

Equipped with 4 automatic extraction cassettes for cat. 5e to cat. 8 RJ 45 connectors

| | | | |
|---------|-----------------|---|---|
| 0337 90 | 19" panel - 1 U | ■ | 1 |
|---------|-----------------|---|---|

Empty flat panel to be equipped with cassettes

It can accept a maximum of 4 automatic extraction cassettes:
- copper
- fibre optic

| | | | |
|---------|-----------------|---|---|
| 0337 91 | 19" panel - 1 U | ■ | 1 |
|---------|-----------------|---|---|

Flat high density 48-connector patch panel - 1 U to be equipped

| | | | |
|----------|-----------------|---|---|
| 0 337 93 | 19" panel - 1 U | ■ | 1 |
|----------|-----------------|---|---|

Angled 24-connector patch panel - 1 U

Angled panel to be equipped with connectors

It can accept up to 24 cat. 5e to cat. 8 RJ 45 connectors

| | | | |
|---------|-----------------|---|---|
| 0337 92 | 19" panel - 1 U | ■ | 1 |
|---------|-----------------|---|---|

Angled high density 48-connector patch panel - 1 U to be equipped

Angled panel to be equipped with connectors

It can accept up to 48 cat. 5e to cat. 6A RJ 45 connectors

| | | | |
|---------|-----------------|---|---|
| 0337 94 | 19" panel - 1 U | ■ | 1 |
|---------|-----------------|---|---|

High density cat. 6A RJ 45 connectors

| | | | |
|---------|-----|---|---|
| 0337 73 | UTP | ■ | 1 |
| 0337 75 | STP | ■ | 1 |

Common accessories for flat and angled panels

Port blanking modules

| | | | |
|---------|---|---|----|
| 0337 56 | Divisible 6 port blanking plate for sealing from 1 to 6 ports | ■ | 10 |
|---------|---|---|----|

Cord management

| | | | |
|---------|--|---|---|
| 0337 59 | For use with new generation Quick-Fix; they provide side cord management | ■ | 1 |
|---------|--|---|---|

Specific accessories for flat panels

Cassette for flat panels to be equipped

| | | | |
|---------|--|---|---|
| 0337 55 | Empty removable cassette to be equipped with connectors. It can accept 6 cat. 5e to cat. 8 connectors Extraction by simple pressure of the cassette making installation and maintenance easier Possibility of removing each connector individually | ■ | 1 |
|---------|--|---|---|

* MRP - Maximum Retail Price Inclusive of all taxes including GST.

■ Price available on request.

(1) in meters

Legrand cabling system LCS³ category 6_A

| Cat.Nos | Description | MRP* ₹ / Unit | Pack |
|---------|-------------|------------------|------|
|---------|-------------|------------------|------|

High density cassette for flat panels to be equipped

| | | | |
|---------|--|---|---|
| 0337 95 | Empty removable cassette to be equipped with connectors; it can accept 12 cat. 5e to cat. 6 _A connectors Extraction by simple pressure of the cassette, making installation and maintenance easier | ■ | 1 |
|---------|--|---|---|

Blanking cassette

| | | | |
|---------|-------------------------|---|---|
| 0337 57 | Used to blank the panel | ■ | 1 |
|---------|-------------------------|---|---|

Specific accessories for angled panels

Angled panel cover

| | | | |
|---------|---|---|---|
| 0337 58 | For optimised management of the air flow inside the cabinet | ■ | 1 |
|---------|---|---|---|

Cables for local networks cat. 6A

LSZH - U/UTP - 4 pairs

Performance 500 MHz

| | | | |
|---------|---|---|------------------|
| 0327 87 | Length 500 m Supplied on reel. Weight 25 kg | ■ | 500 ¹ |
|---------|---|---|------------------|

F/UTP - 4 pairs

Performance 500 MHz

| | | | |
|---------|---|---|------------------|
| 0327 78 | Length 500 m Supplied on reel. Weight 25 kg | ■ | 500 ¹ |
|---------|---|---|------------------|

F/UTP - 2 x 4 pairs

Performance 500 MHz

| | | | |
|---------|--|---|------------------|
| 0328 78 | Length 500 m Supplied on reel. Weight 65 kg | ■ | 500 ¹ |
|---------|--|---|------------------|

S/FTP - 4 pairs

Performance 600 MHz

| | | | |
|---------|--|---|------------------|
| 0327 77 | Length 500 m Supplied on reel. Weight 30 kg | ■ | 500 ¹ |
|---------|--|---|------------------|

RJ 45 patch cords and user cords cat. 6A

PVC - U/UTP unshielded impedance 100 Ω

| | | | |
|---------|------------|---|---|
| 0518 82 | Length 1 m | ■ | 1 |
| 0518 83 | Length 2 m | ■ | 1 |
| 0518 84 | Length 3 m | ■ | 1 |
| 0518 85 | Length 5 m | ■ | 1 |

LSZH - U/UTP unshielded impedance 100 Ω

| | | | |
|---------|------------|---|---|
| 0518 78 | Length 1 m | ■ | 1 |
| 0518 79 | Length 2 m | ■ | 1 |
| 0518 80 | Length 3 m | ■ | 1 |
| 0518 81 | Length 5 m | ■ | 1 |
| 0518 74 | Length 1 m | ■ | 1 |
| 0518 75 | Length 2 m | ■ | 1 |
| 0518 76 | Length 3 m | ■ | 1 |
| 0518 77 | Length 5 m | ■ | 1 |

PVC - S/FTP shielded impedance 100 Ω

| | | | |
|---------|--------------|---|---|
| 0518 16 | Length 0.5 m | ■ | 1 |
| 0517 80 | Length 1 m | ■ | 5 |
| 0517 81 | Length 2 m | ■ | 5 |
| 0517 82 | Length 3 m | ■ | 5 |
| 0517 83 | Length 5 m | ■ | 5 |

Bold Cat.Nos are products normally available with Legrand (India) Stockists. Cat.Nos that are not bold - delivery within 4 - 8 weeks from the date of order. Bold packing quantity is our mandatory packing. Orders to be placed by Legrand (India) Stockist in multiples of the same.



0337 57



0337 58



0327 77

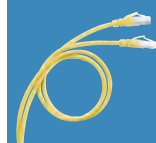

0517 82



0337 90



0337 93



0337 92



0337 94



0337 75



0337 56



0337 59



0337 55

Legrand cabling system LCS³ category 6_A

| Cat.Nos | Description | MRP* ₹ / Unit | Pack |
|---------|-------------|------------------|------|
|---------|-------------|------------------|------|

LSZH - S/FTP shielded impedance 100 Ω

| | | | |
|---------|------------|---|---|
| 0518 70 | Length 1 m | ■ | 1 |
| 0518 71 | Length 2 m | ■ | 1 |
| 0518 72 | Length 3 m | ■ | 1 |
| 0518 73 | Length 5 m | ■ | 1 |
| 0518 66 | Length 1 m | ■ | 1 |
| 0518 67 | Length 2 m | ■ | 1 |
| 0518 68 | Length 3 m | ■ | 1 |
| 0518 69 | Length 5 m | ■ | 1 |

Arteor RJ 45 socket cat. 6_A

360° metal shielding

STP - 1 module

| | | | |
|---------|-------------------------------|---|----|
| 5734 32 | White | ■ | 20 |
| 5728 06 | Magnesium | ■ | 10 |
| 5723 52 | White with green shutter | ■ | 10 |
| 5728 52 | Magnesium with green shutter | ■ | 10 |
| 5723 51 | White with orange shutter | ■ | 10 |
| 5728 51 | Magnesium with orange shutter | ■ | 10 |

STP with controlled access - 2 modules

Supplied with 2 keys for 5 sockets

| | | | |
|---------|----------------------------|---|---|
| 5723 50 | White with red shutter | ■ | 5 |
| 5728 50 | Magnesium with red shutter | ■ | 5 |

UTP - 1 module

| | | | |
|---------|-------------------------------|---|----|
| 5723 49 | White | ■ | 10 |
| 5728 49 | Magnesium | ■ | 10 |
| 5723 59 | White with green shutter | ■ | 10 |
| 5728 59 | Magnesium with green shutter | ■ | 10 |
| 5723 58 | White with orange shutter | ■ | 10 |
| 5728 58 | Magnesium with orange shutter | ■ | 10 |

UTP with controlled access - 2 modules

Supplied with 2 keys for 5 sockets

| | | | |
|---------|----------------------------|---|---|
| 5723 57 | White with red shutter | ■ | 5 |
| 5728 57 | Magnesium with red shutter | ■ | 5 |

Legrand cabling system LCS³ category 6

Cat. 6 patch panels equipped with 24 RJ 45 connectors

Flat panels

24 RJ 45 connectors - 1 U

| | | | |
|----------------|-----|---|---|
| 0337 60 | UTP | ■ | 1 |
| 0337 61 | FTP | ■ | 1 |
| 0337 62 | STP | ■ | 1 |

Flat 24-connector patch panels - 1 U to be equipped

Flat panel with empty cassettes to be equipped with connectors

Equipped with 4 automatic extraction cassettes for cat. 5e to cat. 8 RJ 45 connectors

| | | | |
|---------|-----------------|---|---|
| 0337 90 | 19" panel - 1 U | ■ | 1 |
|---------|-----------------|---|---|

* MRP - Maximum Retail Price Inclusive of all taxes including GST.

■ Price available on request.

(1) in meters

Legrand cabling system LCS³ category 6

| Cat.Nos | Description | MRP* ₹ / Unit | Pack |
|---------|-------------|------------------|------|
|---------|-------------|------------------|------|

Empty flat panel to be equipped with cassettes

It can accept a maximum of 4 automatic extraction cassettes:
- copper
- fibre optic

| | | | |
|---------|-----------------------|---|---|
| 0337 91 | 19" patch panel - 1 U | ■ | 1 |
|---------|-----------------------|---|---|

Flat high density 48-connector patch panel - 1 U to be equipped

| | | | |
|---------|-----------------|---|---|
| 0337 93 | 19" panel - 1 U | ■ | 1 |
|---------|-----------------|---|---|

Angled 24-connector patch panels - 1 U

Angled panel to be equipped with connectors

It can accept up to 24 cat. 5e to cat. 8 RJ 45 connectors

| | | | |
|---------|-----------------|---|---|
| 0337 92 | 19" panel - 1 U | ■ | 1 |
|---------|-----------------|---|---|

Angled high density 48-connector patch panel - 1 U to be equipped

Angled panel to be equipped with connectors

It can accept up to 48 cat. 5e to cat. 6_A RJ 45 connectors

| | | | |
|---------|-----------------|---|---|
| 0337 94 | 19" panel - 1 U | ■ | 1 |
|---------|-----------------|---|---|

Cat. 6 high density RJ 45 connectors

| | | | |
|----------------|-----|---|---|
| 0337 63 | UTP | ■ | 1 |
| 0337 64 | FTP | ■ | 1 |
| 0337 65 | STP | ■ | 1 |

Common accessories for flat and angled panels

Port blanking modules

| | | | |
|---------|---|---|----|
| 0337 56 | Divisible 6 port blanking plate for sealing from 1 to 6 ports | ■ | 10 |
|---------|---|---|----|

Cord management

| | | | |
|---------|--|---|---|
| 0337 59 | For use with new generation Quick-Fix; they provide side cord management | ■ | 1 |
|---------|--|---|---|

Specific accessories for flat panels

| | | | |
|---------|--|---|---|
| 0337 55 | Cassette for flat panels to be equipped | ■ | 1 |
| 0337 95 | High density cassette for flat panels to be equipped | ■ | 1 |
| 0337 57 | Blanking cassette Used to blank the panel | ■ | 1 |

Specific accessories for angled panels

Angled panel cover

| | | | |
|---------|---|---|---|
| 0337 58 | For optimised management of the air flow inside the cabinet | ■ | 1 |
|---------|---|---|---|

Bold Cat.Nos are products normally available with Legrand (India) Stockists. Cat.Nos that are not bold - delivery within 4 - 8 weeks from the date of order. Bold packing quantity is our mandatory packing. Orders to be placed by Legrand (India) Stockist in multiples of the same.



5734 32



5723 57



0337 93



0337 92



0337 94



0337 63



0337 56



0337 59



0337 55



0337 57



0337 58



0337 61



0337 90

Legrand cabling system LCS³ category 6

| Cat.Nos | Description | MRP* ₹ / Unit | Pack |
|---------|-------------|------------------|------|
|---------|-------------|------------------|------|

Cables for cat. 6 LANs

Cables with 4 pairs or 2 x 4 twisted pairs
100 ohms. Colour code TIA/EIA
Conform to standards ISO/IEC 11801
Ed. 2.0, EN 50173-1 and TIA/EIA 568 C

LSZH - U/UTP - 4 pairs

| | | | |
|----------|--|---|------------------|
| 0327 54I | Length 305 m. Supplied in cardboard box Weight 16 kg., Violet RAL 4005 | ■ | 305 ¹ |
| 0328 61 | Length 500 m. Supplied on reel. Weight 18 kg. Blue RAL 5015 | ■ | 500 ¹ |

PVC - U/UTP - 4 pairs

| | | | |
|----------|---|---|------------------|
| 0327 55W | Length 305 m Supplied in cardboard box, Weight 13 kg., White RAL 9003, MOQ 50 Box | ■ | 305 ¹ |
| 0327 55 | Length 305 m Supplied in cardboard box Weight 13 kg. Blue RAL 5015 | ■ | 305 ¹ |
| 0327 55O | Length 305 m Supplied in cardboard box, Weight 13 kg., Orange RAL 2008, MOQ 50 Box | ■ | 305 ¹ |
| 0327 55G | Length 305 m Supplied in cardboard box, Weight 13 kg., Green RAL 6018/6024, MOQ 50 Box | ■ | 305 ¹ |

LSZH - U/UTP - 4 pairs

| | | | |
|----------|--|---|------------------|
| 0327 54I | Length 305 m Supplied in cardboard box. Weight 16 kg | ■ | 305 ¹ |
| 0328 61 | Length 500 m Supplied on reel. Weight 18 kg | ■ | 500 ¹ |

PVC - U/UTP - 4 pairs

| | | | |
|---------|---|---|------------------|
| 0327 55 | Length 305m Supplied in cardboard box. Weight 13 kg | ■ | 305 ¹ |
|---------|---|---|------------------|

LSZH - F/UTP - 4 pairs

| | | | |
|---------|---|---|------------------|
| 0328 56 | Length 305 m. Supplied on reel. Weight 17 kg | ■ | 305 ¹ |
| 0327 56 | Length 500 m. Supplied on reel. Weight 25 kg | ■ | 500 ¹ |

PVC - F/UTP - 4 pairs

| | | | |
|---------|--|---|------------------|
| 0328 57 | Length 305 m Supplied in cardboard box. Weight 17 kg | ■ | 305 ¹ |
| 0327 58 | Length 500 m Supplied on reel. Weight 25 kg | ■ | 500 ¹ |

LSZH - F/UTP - 2 x 4 pairs

| | | | |
|---------|---|---|------------------|
| 0327 76 | Length 500 m. Supplied on reel. Weight 48 kg | ■ | 500 ¹ |
|---------|---|---|------------------|

LSZH - SF/UTP - 4 pairs

| | | | |
|---------|---|---|------------------|
| 0327 57 | Length 500 m. Supplied on reel. Weight 29 kg | ■ | 500 ¹ |
|---------|---|---|------------------|

PVC - SF/UTP - 4 pairs

| | | | |
|---------|---|---|------------------|
| 0327 59 | Length 500 m. Supplied on reel. Weight 30 kg | ■ | 500 ¹ |
|---------|---|---|------------------|

* MRP - Maximum Retail Price Inclusive of all taxes including GST.

■ Price available on request.

(1) in meters

Legrand cabling system LCS³ category 6

| Cat.Nos | Description | MRP* ₹ / Unit | Pack |
|---------|-------------|------------------|------|
|---------|-------------|------------------|------|

LSZH - F/FTP - 2 x 4 pairs

| | | | |
|---------|----------------------------|---|--|
| 0327 98 | Length 500 m. Weight 62 kg | ■ | |
|---------|----------------------------|---|--|

PVC - F/FTP - 4 pairs

| | | | |
|---------|------------------------------|---|--|
| 0327 99 | Length 500 m. Weight 25,2 kg | ■ | |
|---------|------------------------------|---|--|

RJ 45 patch cords and user cords cat. 6

RJ 45 - RJ 45 right

PVC - U/UTP unscreened impedance 100 Ω

| | | | |
|---------|--------------|---|---|
| 0518 18 | Length 0.5 m | ■ | 1 |
| 0517 72 | Length 1 m | ■ | 1 |
| 0517 73 | Length 2 m | ■ | 1 |
| 0517 74 | Length 3 m | ■ | 1 |
| 0517 75 | Length 5 m | ■ | 1 |

LSZH - U/UTP unscreened impedance 100 Ω

| | | | |
|---------|------------|---|---|
| 0518 62 | Length 1 m | ■ | 1 |
| 0518 63 | Length 2 m | ■ | 1 |
| 0518 64 | Length 3 m | ■ | 1 |
| 0518 65 | Length 5 m | ■ | 1 |
| 0518 58 | Length 1 m | ■ | 1 |
| 0518 59 | Length 2 m | ■ | 1 |
| 0518 60 | Length 3 m | ■ | 1 |
| 0518 61 | Length 5 m | ■ | 1 |

PVC - F/UTP screened impedance 100 Ω

| | | | |
|---------|--------------|---|---|
| 0518 15 | Length 0.5 m | ■ | 1 |
| 0517 62 | Length 1 m | ■ | 1 |
| 0517 63 | Length 2 m | ■ | 1 |
| 0517 64 | Length 3 m | ■ | 1 |
| 0517 65 | Length 5 m | ■ | 1 |

LSZH - F/UTP screened impedance 100 Ω

| | | | |
|---------|------------|---|---|
| 0518 54 | Length 1 m | ■ | 1 |
| 0518 55 | Length 2 m | ■ | 1 |
| 0518 56 | Length 3 m | ■ | 1 |
| 0518 57 | Length 5 m | ■ | 1 |
| 0518 50 | Length 1 m | ■ | 1 |
| 0518 51 | Length 2 m | ■ | 1 |
| 0518 52 | Length 3 m | ■ | 1 |
| 0518 53 | Length 5 m | ■ | 1 |

PVC - SF/UTP shielded impedance 100 Ω

| | | | |
|---------|------------|---|---|
| 0517 52 | Length 1 m | ■ | 5 |
| 0517 53 | Length 2 m | ■ | 5 |
| 0517 54 | Length 3 m | ■ | 5 |
| 0517 55 | Length 5 m | ■ | 5 |

Bold Cat.Nos are products normally available with Legrand (India) Stockists.
Cat.Nos that are not bold - delivery within 4 - 8 weeks from the date of order.
Bold packing quantity is our mandatory packing. Orders to be placed by
Legrand (India) Stockist in multiples of the same.

Legrand cabling system LCS³ category 6

| Cat.Nos | Description | MRP* ₹ / Unit | Pack |
|---------|-------------|------------------|------|
|---------|-------------|------------------|------|

RJ 45 sockets

Sockets with LCS³ quick-fixing crimp connector. Take AWG 22 single-core cables up to AWG 26 and AWG 24 multicore cables. Contacts marked with dual colour code and wiring schemes T 568 A and T 568 B. Conforming to standards ISO/IEC 11801 Ed. 2.0, EN 50173-1 and TIA/EIA 568

Arteor RJ 45 socket cat. 6

UTP - 1 module

| | | | |
|---------|-------------------------------|---|----|
| 5734 28 | White | ■ | 20 |
| 5736 28 | Magnesium | ■ | 20 |
| 5723 54 | White with orange shutter | ■ | 10 |
| 5728 54 | Magnesium with orange shutter | ■ | 10 |
| 5723 55 | White with green shutter | ■ | 10 |
| 5728 55 | Magnesium with green shutter | ■ | 10 |

UTP - 2 modules

| | | | |
|---------|-----------|---|----|
| 5734 74 | White | ■ | 10 |
| 5736 74 | Magnesium | ■ | 10 |

UTP - 2 modules - round

| | | | |
|---------|-----------|---|----|
| 5723 24 | White | ■ | 10 |
| 5728 24 | Magnesium | ■ | 10 |

UTP with controlled access - 2 modules

Supplied with 2 keys for 5 sockets

| | | | |
|---------|----------------------------|---|---|
| 5723 53 | White with red shutter | ■ | 5 |
| 5728 53 | Magnesium with red shutter | ■ | 5 |

UTP retractable RJ 45 sockets - 4 modules

With integrated retractable cord (0.9 m)
Winds up automatically with a pushbutton

| | | | |
|---------|-----------|---|---|
| 5723 39 | White | ■ | 1 |
| 5728 39 | Magnesium | ■ | 1 |

FTP - 1 module

| | | | |
|---------|-----------|---|----|
| 5723 22 | White | ■ | 10 |
| 5728 22 | Magnesium | ■ | 10 |

FTP - 2 modules

| | | | |
|---------|-----------|---|----|
| 5734 76 | White | ■ | 10 |
| 5736 76 | Magnesium | ■ | 10 |

Shielded STP - 1 module

| | | | |
|---------|-----------|---|----|
| 5734 34 | White | ■ | 10 |
| 5736 34 | Magnesium | ■ | 10 |

Shielded STP - 2 modules

| | | | |
|---------|-----------|---|----|
| 5734 77 | White | ■ | 10 |
| 5736 77 | Magnesium | ■ | 10 |

Mylic RJ 45 socket cat. 6

UTP - 1 module

| | | | |
|---------|-------|---|----|
| 6755 45 | White | ■ | 20 |
|---------|-------|---|----|

* MRP - Maximum Retail Price Inclusive of all taxes including GST.

■ Price available on request.

(1) in meters



5736 28



5728 24



6755 45

Legrand cabling system LCS³ category 6

| Cat.Nos | Description | MRP* ₹ / Unit | Pack |
|---------|-------------|------------------|------|
|---------|-------------|------------------|------|

Myrius RJ 45 sockets cat. 6

UTP - 1 module

| | | | |
|---------|-------|---|----|
| 6730 55 | White | ■ | 20 |
| 6731 55 | Black | ■ | 20 |

UTP - 2 modules

| | | | |
|---------|-------|---|----|
| 6730 56 | White | ■ | 20 |
| 6731 56 | Black | ■ | 20 |

Soliroc RJ 45 sockets cat. 6 - IK 10

| | | | |
|---------|---|---|----|
| 0778 91 | IP 20 For at-risk areas or areas with no surveillance FTP socket | ■ | 10 |
|---------|---|---|----|

Plexo RJ 45 sockets cat. 6 - IP 55 closed flap IK 07

Protection against water, dust. For industrial sites

| | | | |
|---------|---|---|-------|
| 0695 69 | FTP socket Grey/white | ■ | 5/100 |
| 0695 61 | UTP socket Grey/white | ■ | 1/20 |
| 0695 81 | Adaptor for RJ 45 socket Weatherproofing ensured (IP 44) plug inserted Grey/white | ■ | 1 |

Plexo 66 RJ 45 socket cat. 6 - IP 66 - IK 08

FTP socket

| | | | |
|---------|---|---|---|
| 0904 67 | 9 contacts Weatherproofing ensured (IP 66) with plug inserted Inclined 90° Grey RAL 7016/T029 | ■ | 1 |
|---------|---|---|---|

Patch panels cat. 6

| | | | |
|---------|--|---|---|
| 6327 91 | 24 x RJ 45 connectors, for unshielded keystone | ■ | 1 |
|---------|--|---|---|

Keystone RJ 45 sockets cat. 6

| | | | |
|---------|---|---|----|
| 0765 88 | Cat 6 UTP socket with fast connection thanks to integrated crimping | ■ | 10 |
|---------|---|---|----|

Surface mounting box

1 or 2 ports

| | | | |
|---------|--|---|----|
| 6327 79 | For keystone connectors Provides solution for integration of keystone in surface mounting installations | ■ | 20 |
|---------|--|---|----|

Cables for cat 6 LANs 24 AWG

U/UTP - 4 Pairs

| | | | |
|----------|---|---|-----|
| 6327 24 | Length 305 m Supplied in cardboard box Weight 16 kg. Dark grey RAL 7037 | ■ | 305 |
| 6327 24W | Length 305 m Supplied in cardboard box Weight 16 kg. White RAL 9003. MOQ - 50 box | ■ | 305 |
| 6327 24O | Length 305 m Supplied in cardboard box Weight 16 kg. Orange RAL 2008 MOQ 50 Box | ■ | 305 |
| 6327 24G | Length 305 m Supplied in cardboard box Weight 16 kg. Green RAL 6018 / 6024 MOQ 50 Box | ■ | 305 |



6730 56



0778 91



0695 69



0904 67



6327 91



0765 88

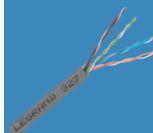

6327 24

Bold Cat.Nos are products normally available with Legrand (India) Stockists. Cat.Nos that are not bold - delivery within 4 - 8 weeks from the date of order. Bold packing quantity is our mandatory packing. Orders to be placed by Legrand (India) Stockist in multiples of the same.

Legrand cabling system LCS³ category 6

| Cat.Nos | Description | MRP* ₹ / Unit | Pack |
|---------|-------------|------------------|------|
|---------|-------------|------------------|------|

Patch cords

RJ 45 - RJ 45
PVC



0337 51

U/UTP cat. 6 unscreened impedance 100 Ω

Light blue

| | | | |
|---------|--------------|---|----|
| 6327 50 | Length 1 m | ■ | 20 |
| 6327 51 | Length 1.5 m | ■ | 20 |
| 6327 52 | Length 2 m | ■ | 20 |
| 6327 53 | Length 3 m | ■ | 20 |
| 6327 54 | Length 5 m | ■ | 20 |



6327 50

0337 90

F/UTP cat. 6 screened impedance 100 Ω

Blue-green

| | | | |
|---------|------------|---|----|
| 6327 60 | Length 1 m | ■ | 20 |
| 6327 61 | Length 2 m | ■ | 20 |
| 6327 62 | Length 3 m | ■ | 20 |
| 6327 63 | Length 5 m | ■ | 20 |



6327 60



0337 93

Legrand cabling system LCS³ category 5e

Cat. 5e patch panels equipped with 24 RJ 45 connectors

**Flat panel with empty cassettes to be equipped with
connectors**



0337 92

24 RJ 45 connectors - 1 U

| | | | |
|---------|-----|---|---|
| 0337 50 | UTP | ■ | 1 |
| 0337 51 | FTP | ■ | 1 |



0337 94

Flat 24-connector patch panels - 1 U to be equipped

**Flat panel with empty cassettes to be equipped with
connectors**



0337 53

Equipped with 4 automatic extraction cassettes for cat. 5e to
cat. 8 RJ 45 connectors

| | | | |
|---------|-----------------|---|---|
| 0337 90 | 19" panel - 1 U | ■ | 1 |
|---------|-----------------|---|---|



0337 56

Empty flat panel to be equipped with cassettes

It can accept a maximum of 4 automatic extraction cassettes:
- copper
- fibre optic

| | | | |
|---------|-----------------|---|---|
| 0337 91 | 19" panel - 1 U | ■ | 1 |
|---------|-----------------|---|---|



0337 59

Flat high density 48-connector patch panel - 1 U to be equipped

| | | | |
|---------|-----------------|---|---|
| 0337 93 | 19" panel - 1 U | ■ | 1 |
|---------|-----------------|---|---|



0337 55

Angled 24-connector patch panel - 1 U

Angled panel to be equipped with connectors

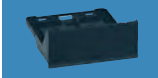

0337 57

It can accept up to 24 cat. 5e to cat. 8 RJ 45 connectors

| | | | |
|---------|-----------------|---|---|
| 0337 92 | 19" panel - 1 U | ■ | 1 |
|---------|-----------------|---|---|



0337 58

Angled high density 48-connector patch panel - 1 U to be equipped

| | | | |
|---------|-----------------|---|---|
| 0337 94 | 19" panel - 1 U | ■ | 1 |
|---------|-----------------|---|---|

* MRP - Maximum Retail Price Inclusive of all taxes including GST.
■ Price available on request.
(1) in meters

Legrand cabling system LCS³ category 5e

| Cat.Nos | Description | MRP* ₹ / Unit | Pack |
|---------|-------------|------------------|------|
|---------|-------------|------------------|------|

Cat. 5e High density RJ 45 connectors

| | | | |
|---------|-----|---|---|
| 0337 53 | UTP | ■ | 1 |
| 0337 54 | FTP | ■ | 1 |

Common accessories for flat and angled panels

Port blanking modules

| | | | |
|---------|--|---|----|
| 0337 56 | Divisible 6 port blanking plate for sealing from 1 to 6 ports | ■ | 10 |
|---------|--|---|----|

Cord management

| | | | |
|---------|--|---|---|
| 0337 59 | For use with new generation Quick-Fix They provide side cord management | ■ | 1 |
|---------|--|---|---|

Specific accessories for flat panels

| | | | |
|---------|---|---|---|
| 0337 55 | Cassette for flat panels to be equipped | ■ | 1 |
| 0337 95 | High density cassette for flat panels to be equipped | ■ | 1 |
| 0337 57 | Blanking cassette Used to blank the panel | ■ | 1 |

Specific accessories for angled panels

Angled panel cover

| | | | |
|---------|--|---|---|
| 0337 58 | For optimised management of the air flow inside the cabinet | ■ | 1 |
|---------|--|---|---|

Cables for local networks cat. 5e

LSZH - U/UTP - 4 pairs

| | | | |
|---------|--|---|------------------|
| 0327 50 | Length 305 m Supplied in cardboard box. Weight 16 kg | ■ | 305 ¹ |
| 0328 53 | Length 500 m Supplied on reel. Weight 15 kg | ■ | 500 ¹ |

PVC - U/UTP - 4 pairs

| | | | |
|---------|---|---|------------------|
| 0327 51 | Length 305 m Supplied in cardboard box. Weight 9 kg | ■ | 305 ¹ |
|---------|---|---|------------------|

LSZH - F/UTP - 4 pairs

| | | | |
|---------|--|---|------------------|
| 0327 52 | Length 305 m Supplied in cardboard box. Weight 12 kg | ■ | 305 ¹ |
| 0328 50 | Length 500 m Supplied on reel. Weight 21 kg | ■ | 500 ¹ |

PVC - F/UTP - 4 pairs

| | | | |
|---------|---|---|------------------|
| 0327 53 | Length 305 m Supplied by box. Weight 11 kg | ■ | 305 ¹ |
|---------|---|---|------------------|

RJ 45 patch cords and user cords cat. 5e

RJ 45 - RJ 45 right

PVC - U/UTP unscreened impedance 100 Ω

Grey

| | | | |
|---------|--------------|---|---|
| 0518 17 | Length 0.5 m | ■ | 1 |
| 0516 36 | Length 1 m | ■ | 1 |
| 0516 37 | Length 2 m | ■ | 1 |
| 0516 38 | Length 3 m | ■ | 1 |
| 0516 39 | Length 5 m | ■ | 1 |

Bold Cat.Nos are products normally available with Legrand (India) Stockists.
Cat.Nos that are not bold - delivery within 4 - 8 weeks from the date of order.
Bold packing quantity is our mandatory packing. Orders to be placed by
Legrand (India) Stockist in multiples of the same.

Legrand cabling system LCS³ category 5e

| Cat.Nos | Description | MRP* ₹ / Unit | Pack |
|---------|-------------|------------------|------|
|---------|-------------|------------------|------|

F/UTP screened impedance 100 Ω

Grey

| | | | |
|---------|--------------|---|---|
| 0516 14 | Length 0.5 m | ■ | 1 |
| 0516 40 | Length 1 m | ■ | 1 |
| 0516 41 | Length 2 m | ■ | 1 |
| 0516 42 | Length 3 m | ■ | 1 |
| 0516 43 | Length 5 m | ■ | 1 |

Myrius RJ 45 sockets cat. 5e

UTP - 1 module

| | | | |
|---------|-------|---|----|
| 6730 54 | White | ■ | 20 |
| 6731 54 | Black | ■ | 20 |

Mylic RJ 45 sockets cat. 5e

UTP - 1 module

| | | | |
|---------|-------|---|----|
| 6755 47 | White | ■ | 20 |
|---------|-------|---|----|

Arteor RJ 45 socket cat. 5e

UTP - 1 module

| | | | |
|---------|-----------|---|----|
| 5734 29 | White | ■ | 20 |
| 5736 29 | Magnesium | ■ | 20 |

UTP - 2 modules

| | | | |
|---------|-----------|---|----|
| 5734 75 | White | ■ | 10 |
| 5736 75 | Magnesium | ■ | 20 |

FTP - 1 module

| | | | |
|---------|-----------|---|----|
| 5734 30 | White | ■ | 20 |
| 5736 30 | Magnesium | ■ | 20 |

Plexo RJ 45 sockets, cat. 5e - IP 55 closed flap IK 07

Protection against water, dust
For industrial sites

| | | | |
|---------|---|---|------|
| 0695 57 | FTP socket Grey/White | ■ | 1/20 |
| 0695 56 | UTP socket Grey/White | ■ | 1/20 |
| 0695 81 | Adaptor for RJ 45 socket Ensures weatherproofing (IP 44) with the plug inserted Grey/White | ■ | 1 |

Patch panels cat. 5e

| | | | |
|---------|--|---|---|
| 6327 91 | 24 x RJ 45 connectors, for unshielded keystone | ■ | 1 |
|---------|--|---|---|

Keystone RJ 45 sockets cat. 5e

| | | | |
|---------|--|---|----|
| 0765 87 | Cat 5e UTP socket with fast connection thanks to integrated crimping | ■ | 10 |
|---------|--|---|----|

Surface mounting box

1 or 2 ports

| | | | |
|---------|--|---|----|
| 6327 79 | For keystone connectors Provides solution for integration of keystone in surface mounting installations | ■ | 20 |
|---------|--|---|----|

* MRP - Maximum Retail Price Inclusive of all taxes including GST.

■ Price available on request.

(1) in meters

Legrand cabling system LCS³ category 5e

| Cat.Nos | Description | MRP* ₹ / Unit | Pack |
|---------|-------------|------------------|------|
|---------|-------------|------------------|------|

Patch cords

RJ 45 - RJ 45 - PVC

U/UTP cat. 5e unscreened impedance 100 Ω

Light pink

| | | | |
|---------|--------------|---|----|
| 6327 30 | Length 1 m | ■ | 20 |
| 6327 31 | Length 1.5 m | ■ | 20 |
| 6327 32 | Length 2 m | ■ | 20 |
| 6327 33 | Length 3 m | ■ | 20 |
| 6327 34 | Length 5 m | ■ | 20 |

F/UTP cat. 5e screened impedance 100 Ω

Light brown

| | | | |
|---------|------------|---|----|
| 6327 40 | Length 1 m | ■ | 20 |
| 6327 41 | Length 2 m | ■ | 20 |
| 6327 42 | Length 3 m | ■ | 20 |
| 6327 43 | Length 5 m | ■ | 20 |

Legrand cabling system LCS³ doubler sockets, adaptors and accessories

RJ 45 doubler sockets

Arteor - Telephone/Ethernet

| | | | |
|---------|------------------------------|---|----|
| 5723 36 | FTP - 9 contacts - White | ■ | 10 |
| 5728 36 | FTP - 9 contacts - Magnesium | ■ | 10 |
| 5723 35 | UTP - 8 contacts - White | ■ | 10 |
| 5728 35 | UTP - 8 contacts - Magnesium | ■ | 10 |

Mobile doublers

Clip into RJ 45 sockets to double applications

| | | | |
|---------|--|---|----|
| 0327 83 | TV/computer network or telephone double connector | ■ | 10 |
| 0327 47 | Telephone/telephone doubler | ■ | 10 |
| 0327 45 | Computer network/telephone doubler | ■ | 10 |
| 0327 46 | L1/L2 telephone doubler | ■ | 10 |
| 0327 48 | Computer network/computer network double connector | ■ | 10 |

Weatherproof adaptors

IP 55 - IK 07 - Allow all functions to be adapted
2 Mosaic modules IP 55 operation

Grey/White

| | | | |
|---------|---|---|----|
| 0695 80 | Adaptor with smoked flap | ■ | 10 |
| 0695 79 | Adaptor with smoked flap lockable by special tool | ■ | 1 |
| 0695 81 | Adaptor for RJ socket ensuring IP 44 waterproofness cable already connected | ■ | 1 |
| 0919 45 | Locking tool (used for changing vandal-proof screws) | ■ | 1 |

Bold Cat.Nos are products normally available with Legrand (India) Stockists. Cat.Nos that are not bold - delivery within 4 - 8 weeks from the date of order. Bold packing quantity is our mandatory packing. Orders to be placed by Legrand (India) Stockist in multiples of the same.

Legrand cabling system LCS³ doubler sockets, adaptors and accessories

| Cat.Nos | Description | MRP* ₹ / Unit | Pack |
|---------|-------------|------------------|------|
|---------|-------------|------------------|------|

Soliroc adaptor

Used for adapting all functions 2 Mosaic modules

IK 10 - IP 55

| | | | |
|---------|----------------------|---|---|
| 0778 80 | Adaptor with flap | ■ | 1 |
| 0778 81 | Adaptor without flap | ■ | 1 |

Hypra adaptor

| | | | |
|---------|--------------------|---|---|
| 0539 49 | IP 55 adaptor base | ■ | 5 |
|---------|--------------------|---|---|

Cable protection accessories

Plastic material

IP 66/67 guaranteed connection with the pair
Cat.No 0 533 02

IP 55 with no connection for base with blank

Protection for RJ 45 shielded or unshielded cables ensuring a link of category 5

Conform to standards of the IEC 60603-7 series and to standard IEC 61076-3-106 (version 5)

Compatible with products on the market conforming to the standards listed

Plug

| | | | |
|---------|---|---|---|
| 0533 00 | Integrated PE with sealing ring and clamping blades Tool-free assembly Ability to protect cables of category 5e | ■ | 3 |
|---------|---|---|---|

Flush-mounting base

| | | | |
|---------|--|---|---|
| 0533 01 | Locking base Supplied with RJ 45 female/female coupler cat. 5e | ■ | 3 |
|---------|--|---|---|

Kit

| | | | |
|---------|----------------------------|---|---|
| 0533 02 | Flush-mounting base + plug | ■ | 3 |
|---------|----------------------------|---|---|

Protective flap

| | | | |
|---------|---------------------------------|---|---|
| 0533 03 | Fits on base Cat.No 0 533 01 | ■ | 3 |
|---------|---------------------------------|---|---|

RJ plugs for round cables

Gold-coated contacts 1.2 µm

RJ 11

| | | | |
|---------|---------------------------|---|----|
| 0517 01 | 4 contacts, width 9.65 mm | ■ | 50 |
|---------|---------------------------|---|----|

RJ 12

| | | | |
|---------|---------------------------|---|----|
| 0517 02 | 6 contacts, width 9.65 mm | ■ | 50 |
|---------|---------------------------|---|----|

RJ 45 cat. 5e

| | | | |
|---------|----------------------------|---|----|
| 0517 03 | 8 contacts, width 11.70 mm | ■ | 50 |
| 0517 04 | 9 contacts, width 11.70 mm | ■ | 50 |

RJ 45 sleeves

| | | | |
|---------|-------|---|----|
| 0517 06 | Black | ■ | 50 |
| 0517 07 | White | ■ | 50 |

Stripping tool

Slits the sheath and releases the conductors by rotation

For twisted pair cables

Does not damage the conductors

Stripper

| | | | |
|---------|--|---|---|
| 0332 62 | For twisted pair and fibre optic cable | ■ | 1 |
|---------|--|---|---|

* MRP - Maximum Retail Price Inclusive of all taxes including GST.

■ Price available on request.

(1) in meters

Legrand cabling system LCS³ doubler sockets, adaptors and accessories

| Cat.Nos | Description | MRP* ₹ / Unit | Pack |
|---------|-------------|------------------|------|
|---------|-------------|------------------|------|

Cutting pliers

| | | | |
|---------|---|---|---|
| 0327 60 | Cut wires cleanly without damaging the copper | ■ | 1 |
|---------|---|---|---|

Crimping tool for RJ 45 plugs

Used for crimping plugs

RJ 4/6/8/9 contacts

Ratchet control of crimping

mechanism Able to cut and strip cables

| | | | |
|---------|--|---|---|
| 0517 09 | Tool with 3 crimping points High resistance steel material | ■ | 1 |
|---------|--|---|---|

110 tool

| | | | |
|---------|-------------------|---|---|
| 0332 60 | 110 tool | ■ | 1 |
| 0332 61 | Replacement blade | ■ | 1 |

Legrand cabling system LCS³ data and telephone sockets, patch panels, cables

Telephone sockets

RJ 11 and RJ 12 sockets

Equipped with a modular Jack connector with 1/4 turn terminal for fast connection Tap-off possible

| | | | |
|---------|--|---|----|
| 5723 00 | White - RJ 11, 4 contacts 1 module | ■ | 10 |
| - | Aluminium - RJ 11, 4 contacts - 1 module | ■ | 10 |
| 5728 00 | Magnesium - RJ 11, 4 contacts - 1 module | ■ | 10 |
| 5723 13 | White - RJ 11, 4 contacts - 2 modules | ■ | 10 |
| 5728 13 | Magnesium - RJ 11, 4 contacts - 2 modules | ■ | 10 |
| 5723 12 | White - RJ 12, 6 contacts - 2 modules | ■ | 10 |
| 5728 12 | Magnesium - RJ 12, 6 contacts - 2 modules | ■ | 10 |

ISDN socket

Self-stripping 1/4 turn terminals for fast connection. Tap-off possible

| | | | |
|---|--|---|----|
| - | White - 8 contacts, 2.5 mm 2 earth terminal | ■ | 10 |
|---|--|---|----|

Single master - 2 modules

With IDC connection

Conform to British Telecom

| | | | |
|---------|-----------|---|----|
| 5723 10 | White | ■ | 10 |
| 5728 10 | Magnesium | ■ | 10 |

Single secondary - 1 module

With IDC connection

Conform to British Telecom

| | | | |
|---------|-----------|---|---|
| 5723 01 | White | ■ | 5 |
| 5728 01 | Magnesium | ■ | 5 |

Bold Cat.Nos are products normally available with Legrand (India) Stockists. Cat.Nos that are not bold - delivery within 4 - 8 weeks from the date of order. Bold packing quantity is our mandatory packing. Orders to be placed by Legrand (India) Stockist in multiples of the same.

Legrand cabling system LCS³ data and telephone sockets, patch panels, cables

| Cat.Nos | Description | MRP* ₹ / Unit | Pack |
|---------|-------------|------------------|------|
|---------|-------------|------------------|------|

Patch panel telephone 50 ports 110 connect

| | | | |
|---------|-----------------|---|---|
| 0335 79 | 19" panel - 1 U | ■ | 1 |
|---------|-----------------|---|---|

Cables for telephone networks cat. 3

PVC sleeve
Colour white
Colour code TIA/EIA

U/UTP - 50 pairs

| | | | |
|---------|----------------------------------|---|---|
| 0328 91 | Length 500 m Supplied on reel | ■ | 1 |
|---------|----------------------------------|---|---|

U/UTP - 100 pairs

| | | | |
|---------|----------------------------------|---|---|
| 0328 88 | Length 500 m Supplied on reel | ■ | 1 |
|---------|----------------------------------|---|---|

Panels and units for incoming telephone

Panels assembled - 1 U

Fitted with 4 LCS³ RJ 45 units of 12 ports with fast tool-free connection

| | | | |
|---------|---|---|---|
| 0335 31 | 3-6/4-5 contacts for digital telephone | ■ | 1 |
| 0335 30 | 4-5/7-8 contacts for analogue telephone | ■ | 1 |

Incoming telephone units for self-assembly panels

Fitted with 12 LCS³ RJ 45 ports with quick tool-free connection

| | | | |
|---------|---|---|---|
| 0335 33 | 3-6/4-5 contacts for digital telephone | ■ | 2 |
| 0335 32 | 4-5/7-8 contacts for analogue telephone | ■ | 2 |

Audio/video system audio/video sockets

Female HD15 sockets

Used to transmit analogue video streams (VGA, XGA, UXGA depending on graphic card) between a source (computer) and a compatible receiver (video projector, TV, etc)

Arteor - Preterminated sockets - 1 module

Equipped with cord, length 15 cm

| | | | |
|---------|-----------|---|---|
| 5720 97 | White | ■ | 1 |
| 5725 97 | Magnesium | ■ | 1 |

Arteor - Screw-type female HD15 sockets - 2 modules

| | | | |
|---------|-----------|---|---|
| 5722 82 | White | ■ | 1 |
| 5727 82 | Magnesium | ■ | 1 |

Arteor - Screw-type female HD15 sockets 2 modules + 3.5 mm Jack

| | | | |
|---------|-----------|---|---|
| 5722 88 | White | ■ | 1 |
| 5727 88 | Magnesium | ■ | 1 |

Arteor - Solder-type female HD15 sockets 1 module

15 pin

| | | | |
|---------|-----------|---|---|
| 5722 79 | White | ■ | 1 |
| 5727 79 | Magnesium | ■ | 1 |

* MRP - Maximum Retail Price Inclusive of all taxes including GST.
■ Price available on request.



0335 79



5720 97



5720 96



5722 72

Audio/video system audio/video sockets

| Cat.Nos | Description | MRP* ₹ / Unit | Pack |
|---------|-------------|------------------|------|
|---------|-------------|------------------|------|

HDMI type A sockets

Used to transmit high-definition digital audio/video streams between a source (computer, HD-DVD drive, etc) and a compatible receiver (TV, video projector, etc)

Arteor - Preterminated sockets HDMI 1.4 - 1 module

Equipped with cord, length 15 cm

| | | | |
|---------|-----------|---|---|
| 5720 96 | White | ■ | 1 |
| 5725 96 | Magnesium | ■ | 1 |

Arteor - Screw-type sockets HDMI 1.3 - 2 modules

| | | | |
|---------|-----------|---|---|
| 5722 81 | White | ■ | 1 |
| 5727 81 | Magnesium | ■ | 1 |

Jack sockets 3.5 mm

3.5 mm Jack connectors can be used to create audio/video links

Arteor - Preterminated sockets - 1 module

Equipped with cord, length 15 cm

| | | | |
|---------|-----------|---|---|
| 5720 91 | White | ■ | 1 |
| 5725 91 | Magnesium | ■ | 1 |

Arteor - 4 screw-type female 3.5 mm Jack socket - 1 module

| | | | |
|---------|-----------|---|---|
| 5722 74 | White | ■ | 1 |
| 5727 74 | Magnesium | ■ | 1 |

Arteor - Solder-type female 3.5 mm Jack socket - 1 module

| | | | |
|---------|-----------|---|---|
| 5722 78 | White | ■ | 1 |
| 5727 78 | Magnesium | ■ | 1 |

Display port sockets

Used to transmit high-definition digital audio/video streams between a source (laptop, computer, etc) and a compatible receiver (video projector, TV, etc)

Arteor - Preterminated socket - 1 module

Equipped with cord, length 15 cm

| | | | |
|---------|-----------|---|---|
| 5720 90 | White | ■ | 1 |
| 5725 90 | Magnesium | ■ | 1 |

Arteor - Female 2 RCA socket

Preterminated

Equipped with a 15 cm cord

| | | | |
|---------|-----------|---|---|
| 5720 92 | White | ■ | 1 |
| 5725 92 | Magnesium | ■ | 1 |

Connection via screw terminals

| | | | |
|---------|-----------|---|---|
| 5722 72 | White | ■ | 1 |
| 5727 72 | Magnesium | ■ | 1 |

Arteor - Female 3 RCA socket

Preterminated

Equipped with a 15 cm cord

| | | | |
|---------|-----------|---|---|
| 5720 93 | White | ■ | 1 |
| 5725 93 | Magnesium | ■ | 1 |

Bold Cat.Nos are products normally available with Legrand (India) Stockists. Cat.Nos that are not bold - delivery within 4 - 8 weeks from the date of order. Bold packing quantity is our mandatory packing. Orders to be placed by Legrand (India) Stockist in multiples of the same.

Audio/video system audio/video sockets

| Cat.Nos | Description | MRP* ₹ / Unit | Pack |
|---------|-------------|------------------|------|
|---------|-------------|------------------|------|

Connection via screw terminals

| | | | |
|---------|-----------|---|---|
| 5722 73 | White | ■ | 1 |
| 5727 73 | Magnesium | ■ | 1 |

5727 73

Other audio and video sockets

Female BNC 75 socket - 1 module

| | | | |
|---------|-----------|---|---|
| 5722 76 | White | ■ | 1 |
| 5727 76 | Magnesium | ■ | 1 |

5722 76

Arteor - Audio sockets

XLR 3-pin - 2 modules

| | | | |
|---------|--|---|---|
| 5722 83 | White - Fast screw connection female | ■ | 1 |
| 5727 83 | Magnesium - Fast screw connection female | ■ | 1 |
| 5722 77 | White - Fast screw connection male | ■ | 1 |
| 5727 77 | Magnesium - Fast screw connection male | ■ | 1 |

5722 83

Loudspeakers sockets

Terminal 4 mm²

| | | | |
|---------|-----------------------|---|----|
| 5722 80 | White - 2 modules | ■ | 10 |
| 5727 80 | Magnesium - 2 modules | ■ | 10 |
| 5722 70 | White - 1 module | ■ | 10 |
| 5727 70 | Magnesium - 1 module | ■ | 10 |

5727 70

100 V Line Volume Attenuators - 2 modules

Used to adjust power and volume of a 100 V loudspeaker line

| | | | |
|---------|--------------------------|---|---|
| 5722 84 | White - 100 V - 25 W | ■ | 1 |
| 5727 84 | Magnesium - 100 V - 25 W | ■ | 1 |

5722 84

Audio/video system audio/video patch panels, cords and cables

19" patch panels

| | | | |
|---------|---------------------------------|---|---|
| 0335 98 | HD15 19" panel - 12 connectors | ■ | 1 |
| 0335 97 | HDMI 19" panel - 16 connectors | ■ | 1 |
| 0335 96 | XLR 19" panel - 16 connectors | ■ | 1 |
| 0335 99 | SUBD9 19" panel - 12 connectors | ■ | 1 |

0335 98

0335 96

0335 97

0335 99

Cords

For connecting a socket to a terminal

HD15 cord

| | | | |
|---------|--------------|---|---|
| 0517 23 | Length 10 m. | ■ | 1 |
|---------|--------------|---|---|

0517 23

HD15 cord + 3.5 mm Jack

| | | | |
|---------|------------|---|---|
| 0517 22 | Length 2 m | ■ | 1 |
|---------|------------|---|---|

HDMI 1.4 cord

| | | | |
|----------|--------------|---|---|
| 0517 26* | Length 1.5 m | ■ | 1 |
| 0517 27* | Length 5 m | ■ | 1 |
| 0517 20* | Length 10 m | ■ | 1 |

* MRP - Maximum Retail Price Inclusive of all taxes including GST.

■ Price available on request.

* To be introduced shortly.

Audio/video system audio/video patch panels, cords and cables

| Cat.Nos | Description | MRP* ₹ / Unit | Pack |
|---------|-------------|------------------|------|
|---------|-------------|------------------|------|

HDMI booster

| | | | |
|---------|------------------------------------|---|---|
| 0779 30 | Used to extend an HDMI connection. | ■ | 1 |
|---------|------------------------------------|---|---|

XLR cord

| | | | |
|---------|--------------|---|---|
| 0517 24 | Length 10 m. | ■ | 1 |
|---------|--------------|---|---|



0517 24

9-way SUB-D cord

| | | | |
|---------|--------------|---|---|
| 0517 25 | Length 10 m. | ■ | 1 |
|---------|--------------|---|---|

Cables

VGA cables

| | | | |
|---------|-------------|---|---|
| 0327 81 | Length 20 m | ■ | 1 |
|---------|-------------|---|---|

HDMI cables

| | | | |
|---------|-------------|---|---|
| 0327 80 | Length 20 m | ■ | 1 |
|---------|-------------|---|---|

Legrand cabling system LCS³ fibre optic

Equipped 19" optic drawers

Sliding

| | | | |
|---------|---|---|---|
| 0321 61 | 12 SC duplex multi-mode connectors for 24 fibres | ■ | 1 |
| 0321 62 | 24 LC duplex multi-mode connectors for 48 fibres | ■ | 1 |
| 0321 63 | 24 ST multi-mode connectors for 48 fibres | ■ | 1 |
| 0321 64 | 12 SC duplex single-mode connectors for 24 fibres | ■ | 1 |
| 0321 65 | 24 LC duplex single-mode connectors for 48 fibres | ■ | 1 |
| 0321 66 | 12 SC APC duplex single-mode connectors for 24 fibres | ■ | 1 |
| 0321 67 | 24 LC APC duplex single-mode connectors for 48 fibres | ■ | 1 |



0321 62

Rotating

| | | | |
|---------|---|---|---|
| 0321 71 | 36 LC duplex multi-mode connectors for 72 fibres | ■ | 1 |
| 0321 72 | 18 SC duplex multi-mode connectors for 36 fibres | ■ | 1 |
| 0321 73 | 36 LC duplex single-mode connectors for 72 fibres | ■ | 1 |
| 0321 74 | 18 SC duplex single-mode connectors for 36 fibres | ■ | 1 |



0321 72

19" modular optic drawers

Sliding, equipped

| | | | |
|---------|---|---|---|
| 0321 02 | 12 SC duplex multi-mode connectors for 24 fibres | ■ | 1 |
| 0321 04 | 24 LC duplex multi-mode connectors for 48 fibres | ■ | 1 |
| 0321 06 | 12 SC duplex single-mode connectors for 24 fibres | ■ | 1 |

Sliding, to be equipped with fibre optic blocks

It can accept all fibre optic blocks; 4 blocks maximum

| | | | |
|---------|--------------|---|---|
| 0321 00 | Empty drawer | ■ | 1 |
|---------|--------------|---|---|



0321 00

Bold Cat.Nos are products normally available with Legrand (India) Stockists. Cat.Nos that are not bold - delivery within 4 - 8 weeks from the date of order. Bold packing quantity is our mandatory packing. Orders to be placed by Legrand (India) Stockist in multiples of the same.

Legrand cabling system LCS³ fibre optic

| Cat.Nos | Description | MRP* ₹ / Unit | Pack |
|---------|-------------|------------------|------|
|---------|-------------|------------------|------|

Fibre optic blocks

Singlemode fibre optic blocks (9/125 µm)

| | | | |
|---------|--|---|---|
| 0321 17 | ST block for 6 single-mode fibre optics | ■ | 1 |
| 0321 10 | SC duplex block for 6 single-mode fibre optics | ■ | 1 |
| 0321 11 | SC duplex high density block for 12 single-mode fibre optics | ■ | 1 |
| 0321 12 | SC APC duplex block for 6 single-mode fibre optics | ■ | 1 |
| 0321 13 | LC duplex block for 6 single-mode fibre optics | ■ | 1 |
| 0321 14 | LC duplex block for 12 single-mode fibre optics | ■ | 1 |
| 0321 15 | LC duplex high density block for 24 single-mode fibre optics | ■ | 1 |
| 0321 16 | LC APC duplex block for 12 single-mode fibre optics | ■ | 1 |
| 0321 33 | Single-mode 4 MTP ¹ feedthrough adapter | ■ | 1 |



0321 15



0321 33

Multimode fibre optic blocks (62.5 and 50/125 µm)

| | | | |
|---------|--|---|---|
| 0321 27 | ST block for 6 multimode fibre optics | ■ | 1 |
| 0321 20 | SC duplex block for 6 multimode fibre optics | ■ | 1 |
| 0321 21 | SC duplex high density block for 12 multimode fibre optics | ■ | 1 |
| 0321 23 | LC duplex block for 6 multimode fibre optics | ■ | 1 |
| 0321 24 | LC duplex block for 12 multimode fibre optics | ■ | 1 |
| 0321 25 | LC duplex high density block for 24 multimode fibre optics | ■ | 1 |
| 0321 34 | Multimode 4 MTP ¹ feedthrough adapter | ■ | 1 |



0321 21

Copper block for fibre optic drawer

| | | | |
|---------|---|---|---|
| 0321 32 | "It clips directly to the optic drawer to be equipped, Cat.No 0321 00 It gives the possibility of mixing fibre optic and copper" | ■ | 1 |
|---------|---|---|---|

Accessories for optic drawer to be equipped

Accessory for receipt of a fan-out

| | | | |
|---------|---|---|---|
| 0321 28 | It's clipped at the back of the drawer It enables the entry of preterminated Cat.Nos | ■ | 1 |
|---------|---|---|---|

Blank

| | | | |
|---------|-------------|---|---|
| 0321 29 | Blank block | ■ | 1 |
|---------|-------------|---|---|

Pigtail cassette

| | | | |
|---------|--------------------------|---|---|
| 0321 30 | Capacity 24 fibre optics | ■ | 1 |
|---------|--------------------------|---|---|

Coiling kit

| | | | |
|---------|-------------|---|---|
| 0321 31 | 1 accessory | ■ | 1 |
|---------|-------------|---|---|

Modular 19" panel to be equipped with cassettes

| | | | |
|---------|--------------------------|---|---|
| 0321 40 | Depth 190 mm, height 1 U | ■ | 1 |
|---------|--------------------------|---|---|



0321 40

* MRP - Maximum Retail Price Inclusive of all taxes including GST.

■ Price available on request.

1: MTP is a registered trademark of US Conec Ltd

Legrand cabling system LCS³ fibre optic

| Cat.Nos | Description | MRP* ₹ / Unit | Pack |
|---------|-------------|------------------|------|
|---------|-------------|------------------|------|

Optic drawer cassettes

Fibre optic splice cassette

| | | | |
|---------|--|---|---|
| 0321 41 | It can accept all modular fibre optic blocks | ■ | 1 |
|---------|--|---|---|



0321 41

Copper cassette to be equipped

| | | | |
|---------|--|---|---|
| 0337 55 | It can accept 6 cat. 5e, cat. 6 and cat. 6 _A connectors | ■ | 1 |
|---------|--|---|---|

MTP¹ preterminated cassette (MPO compatible)

Front and rear extraction
High performance cassette, low insertion loss
<0.35 dB

| | | | |
|---------|---|---|---|
| 0321 42 | Multimode OM4 cassette (50/125 µm) 24 filaments LC OM4 Type A/C | ■ | 1 |
| 0321 43 | Multimode OM4 cassette (50/125 µm) 12 SC OM4 Type A/C | ■ | 1 |
| 0321 44 | Single-mode OS2 cassette (9/125 µm) type OS2 24 LC OS2 Type A/C | ■ | 1 |
| 0321 45 | Single-mode OS2 cassette (9/125 µm) 12 SC OS2 Type A/C | ■ | 1 |



0321 43

Blanking cassette

| | | | |
|---------|-------------------------|---|---|
| 0337 57 | Used to blank the panel | ■ | 1 |
|---------|-------------------------|---|---|

Adapters

| | | | |
|---------|--|---|---|
| 0321 33 | Single-mode 4 MTP ¹ adapter (installation in cassette 0 321 41) | ■ | 1 |
| 0321 34 | Multi-mode 4 MTP ¹ adapter (installation in cassette 0 321 41) | ■ | 1 |

Accessories for 19" panel to be equipped with cassettes

| | | | |
|---------|---|---|---|
| 0321 46 | Rear cable management accessory For installation on panels Cat.No 0 321 40 | ■ | 1 |
| 0321 47 | Cord management kit (guide/support/door) | ■ | 1 |



0321 46

Pigtails

50/125 µm - OM2 (PC)

Connectors

| | | | |
|---------|-------------|---|----|
| 0322 10 | SC 1 m LSZH | ■ | 10 |
| 0322 11 | LC 1 m LSZH | ■ | 10 |
| 0322 12 | ST 1 m LSZH | ■ | 10 |
| 0322 13 | SC 2 m LSZH | ■ | 10 |
| 0322 14 | LC 2 m LSZH | ■ | 10 |
| 0322 15 | ST 2 m LSZH | ■ | 10 |

Bold Cat.Nos are products normally available with Legrand (India) Stockists. Cat.Nos that are not bold - delivery within 4 - 8 weeks from the date of order. Bold packing quantity is our mandatory packing. Orders to be placed by Legrand (India) Stockist in multiples of the same.

Legrand cabling system LCS³ fibre optic

| Cat.Nos | Description | MRP* ₹ / Unit | Pack |
|---------|-------------|------------------|------|
|---------|-------------|------------------|------|

50/125 µm - OM3 (PC)

Connectors

| | | | |
|---------|-------------|---|----|
| 0322 20 | SC 1 m LSZH | ■ | 10 |
| 0322 21 | LC 1 m LSZH | ■ | 10 |
| 0322 22 | ST 1 m LSZH | ■ | 10 |
| 0322 23 | SC 2 m LSZH | ■ | 10 |
| 0322 24 | LC 2 m LSZH | ■ | 10 |

50/125 µm - OM4 (PC)

Connectors

| | | | |
|---------|-------------|---|----|
| 0322 30 | SC 1 m LSZH | ■ | 10 |
| 0322 31 | LC 1 m LSZH | ■ | 10 |
| 0322 32 | ST 1 m LSZH | ■ | 10 |
| 0322 33 | SC 2 m LSZH | ■ | 10 |
| 0322 34 | LC 2 m LSZH | ■ | 10 |

9/125 µm - OS2 (APC or UPC) - OS1 compatible

Connectors

| | | | |
|---------|---------------------|---|----|
| 0322 40 | SC-APC OS2 1 m LSZH | ■ | 10 |
| 0322 41 | SC-UPC OS2 1 m LSZH | ■ | 10 |
| 0322 42 | LC-APC OS2 1 m LSZH | ■ | 10 |
| 0322 43 | LC-UPC OS2 1 m LSZH | ■ | 10 |
| 0322 44 | ST-UPC OS2 1 m LSZH | ■ | 10 |
| 0322 45 | SC-APC OS2 2 m LSZH | ■ | 10 |
| 0322 46 | SC-UPC OS2 2 m LSZH | ■ | 10 |
| 0322 47 | LC-UPC OS2 2 m LSZH | ■ | 10 |
| 0322 48 | LC-APC OS2 2 m LSZH | ■ | 10 |
| 0322 49 | ST-UPC OS2 2 m LSZH | ■ | 10 |

Set of 12 LC pigtailed

| | | | |
|---------|-------------------------|---|---|
| 0326 24 | OS2 12 pigtailed LC-UPC | ■ | 1 |
| 0326 26 | OM3 12 pigtailed LC-PC | ■ | 1 |
| 0326 71 | OM4 12 pigtailed LC-PC | ■ | 1 |

Pigtail sleeves

| | | | |
|---------|---------------------------|---|---|
| 0327 44 | 40 mm - bag of 50 sheaths | ■ | 1 |
|---------|---------------------------|---|---|

Glue-on connectors 50/125 and 62.5/125 µm

| | | | |
|---------|----|---|----|
| 0331 27 | ST | ■ | 10 |
| 0331 47 | SC | ■ | 10 |
| 0331 00 | LC | ■ | 10 |

Fan-out units

| | | | |
|---------|-----------------------------|---|---|
| 0330 48 | 6 fibre optic fan-out unit | ■ | 1 |
| 0330 49 | 12 fibre optic fan-out unit | ■ | 1 |

* MRP - Maximum Retail Price Inclusive of all taxes including GST.

■ Price available on request.

1: MTP is a registered trademark of US Conec Ltd



0322 20



0322 31



0322 83



0322 81



0322 85



0322 70



0322 72



0322 73



0322 75



0321 50

Legrand cabling system LCS³ fibre optic

| Cat.Nos | Description | MRP* ₹ / Unit | Pack |
|---------|-------------|------------------|------|
|---------|-------------|------------------|------|

Tool case for the preparation of the fibre optic for quick-connect connectors

| | | | |
|---------|--|---|---|
| 0322 70 | It contains the tools required for the preparation of the fibre optic cable, for the completion of a first test to confirm the correct connection of the fibre optic to the connector, and the accessories for easy connection in all situations | ■ | 1 |
|---------|--|---|---|

Quick-connect connectors

OM3/OM4 multimode connectors

Set of 12 connectors

| | | | |
|---------|-----------------------------|---|---|
| 0322 71 | LC PC 50/125 µm, 900/250 µm | ■ | 1 |
| 0322 72 | SC PC 50/125 µm, 900/250 µm | ■ | 1 |

OS2 single-mode connectors

Set of 12 connectors

| | | | |
|---------|-----------------------------|---|---|
| 0322 73 | LC UPC 9/125 µm, 900/250 µm | ■ | 1 |
| 0322 74 | SC UPC 9/125 µm, 900/250 µm | ■ | 1 |
| 0322 75 | SC APC 9/125 µm, 900/250 µm | ■ | 1 |

Precision cleaver for the update of the case kit Cat.No 0326 90

| | | | |
|---------|---|---|---|
| 0322 80 | It's used in conjunction with the kit of the case Cat.No 0 326 90, to cut the fibre optic with precision, and fit the quick-connect connectors, Cat.No 0 322 71 to 0 322 75 | ■ | 1 |
|---------|---|---|---|

Fibre optic cleaning accessories

| | | | |
|---------|-----------------------------|---|---|
| 0322 83 | Ferrule cleaner MPO/MTP1 | ■ | 1 |
| 0322 81 | Ferrule cleaner LC (PC/APC) | ■ | 1 |
| 0322 82 | Ferrule cleaner SC (PC/APC) | ■ | 1 |
| 0322 84 | LC replacement cartridge | ■ | 1 |
| 0322 85 | LC replacement cartridge | ■ | 1 |

Fibre optic drawers with front facing cord management

| | | | |
|---------|---|---|---|
| 0321 50 | 1 U | ■ | 1 |
| 0321 52 | 2 U | ■ | 1 |
| 0321 53 | 4 U | ■ | 1 |
| 0321 51 | UHD Panel to be equipped cassette without rear management 1 U | ■ | 1 |

Very high density cassettes

Multimode OM4 cassette (50/125 µm)

For OM4 type 50/125 µm multimode installations

| | | | |
|---------|---------------------------------|---|---|
| 0321 54 | MPO cassette 12 LC OM4 Type A/C | ■ | 1 |
|---------|---------------------------------|---|---|

Bold Cat.Nos are products normally available with Legrand (India) Stockists. Cat.Nos that are not bold - delivery within 4 - 8 weeks from the date of order. Bold packing quantity is our mandatory packing. Orders to be placed by Legrand (India) Stockist in multiples of the same.

Legrand cabling system LCS³ fibre optic

| Cat.Nos | Description | MRP* ₹ / Unit | Pack |
|---------|-------------|------------------|------|
|---------|-------------|------------------|------|

OS2 cassette (9/125 µm)

For OS2 type 9/125 µm multimode installations

| | | | |
|---------|---------------------------------|---|---|
| 0321 55 | MPO cassette 12 LC OS2 Type A/C | ■ | 1 |
|---------|---------------------------------|---|---|

MTP¹ adapters (MPO compatible)

They are clipped directly to the fibre optic drawers, Cat.Nos 0 321 50/51/52/53

| | | | |
|---------|----------------------------|---|---|
| 0321 56 | Multimode 4 MTP1 adapter | ■ | 1 |
| 0321 57 | Single-mode 4 MTP1 adapter | ■ | 1 |

LC adapter

It's clipped directly to the fibre optic drawers, Cat.Nos 0 321 50/51/52/53

| | | | |
|---------|-------------------------|---|---|
| 0321 58 | Adapter 12 LC multimode | ■ | 1 |
|---------|-------------------------|---|---|

Modular 19" panel to be equipped with cassettes

| | | | |
|---------|--------------------------|---|---|
| 0321 40 | Depth 190 mm, height 1 U | ■ | 1 |
|---------|--------------------------|---|---|

High density MTP1 cassette (MPO compatible)

Fibre optic splice cassette

| | | | |
|---------|--|---|---|
| 0321 41 | It can accept all modular fibre optic blocks | ■ | 1 |
|---------|--|---|---|

Copper cassette to be equipped

| | | | |
|---------|--|---|---|
| 0337 55 | It can accept 6 cat. 5e, cat. 6 and cat. 6A connectors | ■ | 1 |
|---------|--|---|---|

Multimode OM4 cassettes (50/125 µm)

| | | | |
|---------|---|---|---|
| 0321 42 | MTP ¹ cassette (MPO compatible) 24 LC OM4 Type A/C | ■ | 1 |
| 0321 43 | MTP ¹ cassette (MPO compatible) 12 SC OM4 Type A/C | ■ | 1 |

Single-mode OS2 cassettes (9/125 µm)

OS2 type

| | | | |
|---------|---|---|---|
| 0321 44 | MTP ¹ cassette (MPO compatible) 24 LC OS2 Type A/C | ■ | 1 |
| 0321 45 | MTP ¹ cassette (MPO compatible) 12 SC OS2 Type A/C | ■ | 1 |

Blanking cassette

| | | | |
|---------|-------------------------|---|---|
| 0337 57 | Used to blank the panel | ■ | 1 |
|---------|-------------------------|---|---|

MTP¹ adapters

It's installed in splice cassettes, Cat.No 0 321 41
It enables MTP¹/MTP¹ feedthrough

| | | | |
|---------|--|---|---|
| 0321 33 | Single-mode 4 MTP ¹ adapter | ■ | 1 |
| 0321 34 | Multimode 4 MTP ¹ adapter | ■ | 1 |

* MRP - Maximum Retail Price Inclusive of all taxes including GST.

■ Price available on request.

1: MTP is a registered trademark of US Conec Ltd

Legrand cabling system LCS³ fibre optic preterminated solution

| Cat.Nos | Description | MRP* ₹ / Unit | Pack |
|---------|-------------|------------------|------|
|---------|-------------|------------------|------|

Accessories for 19" panel to be equipped with cassette

| | | | |
|---------|--|---|---|
| 0321 46 | Rear cable management accessory For installation on panels Cat.No 0 321 40 | ■ | 1 |
| 0321 47 | Cord management kit (guide/support/door) | ■ | 1 |

High density preterminated fibre optic links

Micro cables OM3 Fan-out - Fan-out

Micro cables with spark gap, output 2 mm

| | | | |
|---------|---|---|---|
| 0324 01 | 6 LC Duplex - 6 LC Duplex Length 10 | ■ | 1 |
| 0324 02 | 6 LC Duplex - 6 LC Duplex Length 20 (m) | ■ | 1 |
| 0324 03 | 6 LC Duplex - 6 LC Duplex Length 30 (m) | ■ | 1 |
| 0324 04 | 6 LC Duplex - 6 LC Duplex Length 40 (m) | ■ | 1 |
| 0324 05 | 6 LC Duplex - 6 LC Duplex Length 50 (m) | ■ | 1 |
| 0324 11 | 12 LC Duplex - 12 LC Duplex Length 10 (m) | ■ | 1 |
| 0324 12 | 12 LC Duplex - 12 LC Duplex Length 20 (m) | ■ | 1 |
| 0324 13 | 12 LC Duplex - 12 LC Duplex Length 30 (m) | ■ | 1 |
| 0324 14 | 12 LC Duplex - 12 LC Duplex Length 40 (m) | ■ | 1 |
| 0324 15 | 12 LC Duplex - 12 LC Duplex Length 50 (m) | ■ | 1 |

Micro cables OS2 Fan-out - Fan-out

Micro cables with spark gap, output 2 mm

| | | | |
|---------|---|---|---|
| 0324 21 | 6 LC Duplex - 6 LC Duplex Length 10 (m) | ■ | 1 |
| 0324 22 | 6 LC Duplex - 6 LC Duplex Length 20 (m) | ■ | 1 |
| 0324 23 | 6 LC Duplex - 6 LC Duplex Length 30 (m) | ■ | 1 |
| 0324 24 | 6 LC Duplex - 6 LC Duplex Length 40 (m) | ■ | 1 |
| 0324 25 | 6 LC Duplex - 6 LC Duplex Length 50 (m) | ■ | 1 |
| 0324 31 | 12 LC Duplex - 12 LC Duplex Length 10 (m) | ■ | 1 |
| 0324 32 | 12 LC Duplex - 12 LC Duplex Length 20 (m) | ■ | 1 |
| 0324 33 | 12 LC Duplex - 12 LC Duplex Length 30 (m) | ■ | 1 |
| 0324 34 | 12 LC Duplex - 12 LC Duplex Length 40 (m) | ■ | 1 |
| 0324 35 | 12 LC Duplex - 12 LC Duplex Length 50 (m) | ■ | 1 |

Bold Cat.Nos are products normally available with Legrand (India) Stockists. Cat.Nos that are not bold - delivery within 4 - 8 weeks from the date of order. Bold packing quantity is our mandatory packing. Orders to be placed by Legrand (India) Stockist in multiples of the same.

Legrand cabling system LCS³ cables

| Cat.Nos | Description | MRP* ₹ / Unit | Pack |
|---------|-------------|------------------|------|
|---------|-------------|------------------|------|

Micro cables OM3 MTP1

| | | | |
|---------|---|---|---|
| 0324 41 | 12 fibre optics - MTP ¹ -MTP ¹ Length 10 (m) | ■ | 1 |
| 0324 42 | 12 fibre optics - MTP ¹ -MTP ¹ Length 20 (m) | ■ | 1 |
| 0324 43 | 12 fibre optics - MTP ¹ -MTP ¹ Length 30 (m) | ■ | 1 |
| 0324 44 | 12 fibre optics - MTP ¹ -MTP ¹ Length 40 (m) | ■ | 1 |
| 0324 45 | 12 fibre optics - MTP ¹ -MTP ¹ Length 50 (m) | ■ | 1 |

Micro cables OS2 MTP1

| | | | |
|---------|---|---|---|
| 0324 51 | 12 fibre optics - MTP ¹ -MTP ¹ Length 10 (m) | ■ | 1 |
| 0324 52 | 12 fibre optics - MTP ¹ -MTP ¹ Length 20 (m) | ■ | 1 |
| 0324 53 | 12 fibre optics - MTP ¹ -MTP ¹ Length 30 (m) | ■ | 1 |
| 0324 54 | 12 fibre optics - MTP ¹ -MTP ¹ Length 40 (m) | ■ | 1 |
| 0324 55 | 12 fibre optics - MTP ¹ -MTP ¹ Length 50 (m) | ■ | 1 |

OM 4 multimode fibre optic cables (50/125 µm)

"Bend insensitive"

For multimode installations 50/125 µm, type OM 4

Aqua sheaths

Suitable for 10 Giga Ethernet networks

Loose tube

| | | | |
|---------|--|---|------|
| 0325 43 | Indoor/outdoor (glass strands) 4 fibres - 2000 m | ■ | 2000 |
| 0325 44 | Indoor/outdoor (glass strands) 8 fibres - 2000 m | ■ | 2000 |
| 0325 45 | Indoor/outdoor (glass strands) 12 fibres - 2000 m | ■ | 2000 |
| 0325 46 | Outdoor, corrugated steel tape 4 fibres - 2000 m | ■ | 2000 |
| 0325 47 | Outdoor, corrugated steel tape 8 fibres - 2000 m | ■ | 2000 |
| 0325 48 | Outdoor, corrugated steel tape 12 fibres - 2000 m | ■ | 2000 |

Tight structure 900 µm

| | | | |
|---------|--|---|------|
| 0326 65 | Indoor/outdoor (glass strands) 6 fibres - 500 m | ■ | 2000 |
| 0326 66 | Indoor/outdoor (glass strands) 6 fibres - 1000 m | ■ | 2000 |
| 0326 67 | Indoor/outdoor (glass strands) 12 fibres - 1000 m | ■ | 2000 |
| 0326 68 | Indoor/outdoor (glass strands) 24 fibres - 1000 m | ■ | 2000 |

OS 2 single-mode fibre optic cables (9/125 µm) - (OS1 compatible)

For single-mode installations 9/125 µm,

type OS 2

Yellow or black sheaths for outdoor,
rodent guard...

Loose tube

| | | | |
|---------|--|---|------|
| 0325 02 | Indoor/outdoor (glass strands) 4 fibres | ■ | 2000 |
| 0325 03 | Indoor/outdoor (glass strands) 8 fibres | ■ | 2000 |
| 0325 23 | Outdoor, corrugated steel tape 4 fibres | ■ | 2000 |

* MRP - Maximum Retail Price Inclusive of all taxes including GST.

■ Price available on request.

1: MTP is a registered trademark of US Conec Ltd

Legrand cabling system LCS³ cables

| Cat.Nos | Description | MRP* ₹ / Unit | Pack |
|---------|-------------|------------------|------|
|---------|-------------|------------------|------|

Loose tube

| | | | |
|---------|---|---|------|
| 0325 24 | Outdoor, corrugated steel tape 8 fibres | ■ | 2000 |
| 0325 25 | Outdoor, corrugated steel tape 24 fibres | ■ | 2000 |
| 0325 12 | Indoor/outdoor (glass strands) 6 fibres | ■ | 2000 |
| 0325 13 | Outdoor, corrugated steel tape 6 fibres | ■ | 2000 |
| 0325 14 | Indoor/outdoor (glass strands) 12 fibres | ■ | 2000 |
| 0325 15 | Outdoor, corrugated steel tape 12 fibres | ■ | 2000 |
| 0325 51 | Indoor/outdoor (glass strands) 24 fibres | ■ | 2000 |

Tight structure 900 µm

| | | | |
|---------|---|---|------|
| 0325 50 | Indoor/outdoor (glass strands) 12 fibres | ■ | 2000 |
|---------|---|---|------|

OM 3 multimode fibre optic cables (50/125 µm)

"Bend insensitive"

For multimode installations 50/125 µm, type OM 3

Aqua sheaths

Suitable for 10 Giga Ethernet networks

Loose tube

| | | | |
|---------|---|---|------|
| 0325 53 | Indoor/outdoor (glass strands) 24 fibres | ■ | 2000 |
| 0325 37 | Indoor/outdoor (glass strands) 4 fibres | ■ | 2000 |
| 0325 38 | Indoor/outdoor (glass strands) 8 fibres | ■ | 2000 |
| 0325 39 | Indoor/outdoor (glass strands) 12 fibres | ■ | 2000 |
| 0325 40 | Outdoor, corrugated steel tape 8 fibres | ■ | 2000 |
| 0325 41 | Outdoor, corrugated steel tape 12 fibres | ■ | 2000 |
| 0325 42 | Outdoor, corrugated steel tape 24 fibres | ■ | 2000 |

Tight structure 900 µm

| | | | |
|---------|---|---|------|
| 0325 10 | Indoor/outdoor (glass strands) 6 fibres | ■ | 2000 |
| 0325 11 | Indoor/outdoor (glass strands) 12 fibres | ■ | 2000 |
| 0325 52 | Indoor/outdoor (glass strands) 24 fibres | ■ | 2000 |

OM 2 multimode fibre optic cables (50/125 µm)

For 50/125 µm multimode installations (OM 2)

Orange jacket or black for outdoor, corrugated

Loose tube

| | | | |
|---------|---|---|------|
| 0325 04 | Indoor/outdoor (universal) 6 fibres | ■ | 2000 |
| 0325 05 | Outdoor, corrugated steel tape 6 fibres | ■ | 2000 |
| 0325 06 | Indoor/outdoor (universal) 12 fibres | ■ | 2000 |
| 0325 07 | Outdoor, corrugated steel tape 12 fibres | ■ | 2000 |

Bold Cat.Nos are products normally available with Legrand (India) Stockists. Cat.Nos that are not bold - delivery within 4 - 8 weeks from the date of order. Bold packing quantity is our mandatory packing. Orders to be placed by Legrand (India) Stockist in multiples of the same.

Legrand cabling system LCS³ fibre optic

| Cat.Nos | Description | MRP* ₹ / Unit | Pack |
|----------------------------|--------------------------------------|------------------|------|
| 900 µm Tight buffer | | | |
| 0325 55 | Indoor/outdoor (universal) 4 fibres | ■ | 2000 |
| 0325 08 | Indoor/outdoor (universal) 6 fibres | ■ | 2000 |
| 0325 09 | Indoor/outdoor (universal) 12 fibres | ■ | 2000 |

Legrand cabling system LCS³ patch cords

OS 1/OS 2 (UPC) single-mode optical cords

SC/SC duplex cords

| | | | |
|---------|-------------|---|---|
| 0326 00 | Length: 1 m | ■ | 3 |
| 0326 01 | Length: 2 m | ■ | 3 |
| 0326 02 | Length: 3 m | ■ | 3 |

SC/LC duplex cords

| | | | |
|---------|-------------|---|---|
| 0326 03 | Length: 1 m | ■ | 3 |
| 0326 04 | Length: 2 m | ■ | 3 |
| 0326 05 | Length: 3 m | ■ | 3 |

LC/LC duplex cords

| | | | |
|---------|---------------|---|---|
| 0326 28 | Length: 0.5 m | ■ | 3 |
| 0326 06 | Length: 1 m | ■ | 3 |
| 0326 07 | Length: 2 m | ■ | 3 |
| 0326 08 | Length: 3 m | ■ | 3 |
| 0326 29 | Length: 5 m | ■ | 3 |

LC/LC Uniboot duplex cords

Reversible polarity

| | | | |
|---------|--------------|---|---|
| 0326 86 | Length: 1 m | ■ | 3 |
| 0326 87 | Length: 2 m | ■ | 3 |
| 0326 88 | Length: 3 m | ■ | 3 |
| 0326 89 | Length: 5 m | ■ | 3 |
| 0326 92 | Length: 10 m | ■ | 3 |

OM 4 multimode fibre optic cords (50/125 µm)

SC/SC duplex cords

| | | | |
|---------|-------------|---|---|
| 0326 30 | Length: 1 m | ■ | 3 |
| 0326 31 | Length: 2 m | ■ | 3 |
| 0326 32 | Length: 3 m | ■ | 3 |

LC/LC duplex cords

| | | | |
|---------|---------------|---|---|
| 0326 33 | Length: 0.5 m | ■ | 3 |
| 0326 34 | Length: 1 m | ■ | 3 |
| 0326 35 | Length: 2 m | ■ | 3 |
| 0326 36 | Length: 3 m | ■ | 3 |
| 0326 37 | Length: 5 m | ■ | 3 |

LC/LC Uniboot duplex cords

Reversible polarity

| | | | |
|---------|--------------|---|---|
| 0326 95 | Length: 1 m | ■ | 3 |
| 0326 96 | Length: 2 m | ■ | 3 |
| 0326 97 | Length: 3 m | ■ | 3 |
| 0326 98 | Length: 5 m | ■ | 3 |
| 0326 99 | Length: 10 m | ■ | 3 |

* MRP - Maximum Retail Price Inclusive of all taxes including GST.

■ Price available on request.

1: MTP is a registered trademark of US Conec Ltd

Legrand cabling system LCS³ fibre optic preterminated solution

| Cat.Nos | Description | MRP* ₹ / Unit | Pack |
|---|-------------|------------------|------|
| OM 3 multimode fibre optic cords (50/125 µm) | | | |
| SC/SC duplex cords | | | |
| 0326 09 | Length: 1 m | ■ | 3 |
| 0326 10 | Length: 2 m | ■ | 3 |
| 0326 11 | Length: 3 m | ■ | 3 |

SC/LC duplex cords

| | | | |
|---------|-------------|---|---|
| 0326 12 | Length: 1 m | ■ | 3 |
| 0326 13 | Length: 2 m | ■ | 3 |
| 0326 14 | Length: 3 m | ■ | 3 |

LC/LC duplex cords

| | | | |
|---------|-------------|---|---|
| 0326 15 | Length: 1 m | ■ | 3 |
| 0326 16 | Length: 2 m | ■ | 3 |
| 0326 17 | Length: 3 m | ■ | 3 |

OM 2 multimode fibre optic cords (50/125 µm)

ST/ST duplex cords

| | | | |
|---------|-------------|---|---|
| 0330 80 | Length: 1 m | ■ | 3 |
| 0330 81 | Length: 2 m | ■ | 3 |
| 0330 82 | Length: 3 m | ■ | 3 |

SC/SC duplex cords

| | | | |
|---------|-------------|---|---|
| 0330 69 | Length: 1 m | ■ | 3 |
| 0330 70 | Length: 2 m | ■ | 3 |
| 0330 71 | Length: 3 m | ■ | 3 |

ST/SC duplex cords

| | | | |
|---------|-------------|---|---|
| 0330 72 | Length: 2 m | ■ | 3 |
| 0330 73 | Length: 3 m | ■ | 3 |

LC/LC duplex cords

| | | | |
|---------|-------------|---|---|
| 0330 61 | Length: 2 m | ■ | 3 |
|---------|-------------|---|---|

SC/LC duplex cords

| | | | |
|---------|-------------|---|---|
| 0330 75 | Length: 1 m | ■ | 3 |
| 0330 63 | Length: 2 m | ■ | 3 |
| 0330 76 | Length: 3 m | ■ | 3 |

LC/ST duplex cords

| | | | |
|---------|-------------|---|---|
| 0330 65 | Length: 2 m | ■ | 3 |
|---------|-------------|---|---|

Fibre optic feedthrough sockets

2 x ST fibre optic feedthrough socket

Bayonet mount (STII compatible)

| | | | |
|---------|-------|---|---|
| 0786 16 | White | ■ | 1 |
|---------|-------|---|---|

2 x SC fibre optic feedthrough socket

"Push-pull" connection

| | | | |
|---------|-------|---|---|
| 0786 17 | White | ■ | 1 |
|---------|-------|---|---|

2 x LC fibre optic feedthrough socket

"Push-pull" connection

| | | | |
|---------|-------|---|---|
| 0786 18 | White | ■ | 1 |
|---------|-------|---|---|

Bold Cat.Nos are products normally available with Legrand (India) Stockists. Cat.Nos that are not bold - delivery within 4 - 8 weeks from the date of order. Bold packing quantity is our mandatory packing. Orders to be placed by Legrand (India) Stockist in multiples of the same.

LIGHTING MANAGEMENT SOLUTIONS

INTRODUCING SMART RANGE OF STANDALONE SENSORS TO PUT A STOP TO ENERGY WASTE



048953
PIR miniature



048955
Microwave



048806
Dual Technology

FEATURES



Dali Dimming
with on/off



Configuration
By App



Adjustable
Time delay



Day Light
harvesting



Occupancy/ Vacancy



Sensitivity
adjustment



Movement detectors

| Cat.Nos | Description | MRP* ₹ / Unit | Pack |
|---------|-------------|------------------|------|
|---------|-------------|------------------|------|

Movement detectors for lighting control

IP 20-IP 55 direction movement detector with 180- 360° detection angle. For 2000 Watt incadescent, 230 V halogen, 1000 VA fluroscent



0488 06



0489 16



0489 53



0489 55

| | | | |
|----------------|--|-------|------|
| 0488 99 | PIR ceiling dectector sensor | 4594 | 1/10 |
| 0488 06 | Dual (PIR+Ultrasonic) ceiling mounted | 9476 | 1/10 |
| 0488 07 | PIR ceiling mounted sensor | 9556 | 1/10 |
| 0488 17 | PIR ceiling mounted for corridor | 10320 | 1/10 |
| 0488 04 | PIR ceiling mounted sensor with dual load | 10908 | 1/10 |
| 0489 17 | PIR wall mounted sensor with 180° detection | 15622 | 1/10 |
| 0489 16 | Dual (PIR+Ultrasonic)wall mounted with 2 outputs | 18188 | 1/10 |
| 0489 33 | PIR WALL mounted Sensor 270° for outdoor | 20152 | 1/10 |
| 0489 32 | PIR ceiling mounted for warehouse | 18186 | 1/10 |
| 0489 53 | PIR ceiling mounted with DALI Dimming | 14330 | 1/10 |
| 0489 54 | PIR ceiling mounted | 12716 | 1/10 |
| 0489 55 | Microwave ceiling mounted with DALI dimming | 15646 | 1/10 |
| 0488 75 | Surface mount box | 752 | 1/10 |
| 0882 30 | Configuration tool | 12100 | 1/10 |

Video door entry systems

| Cat.Nos | Description | MRP* ₹ / Unit | Pack |
|---------|-------------|------------------|------|
|---------|-------------|------------------|------|

Colour image digital video door entry system kit



3695 80



3695 70



3695 60



3695 50



3695 00

| | | | |
|---------|---|-------|---|
| 3695 80 | Basic video kit 7" hands free | 13526 | 1 |
| 3695 70 | Basic video kit 7" handset | 14420 | 1 |
| 3695 60 | Basic video kit 4.3" hands free | 12514 | 1 |
| 3695 50 | Basic video kit 4.3" handset | 12370 | 1 |
| 3695 00 | Basic audio kit handset | 6678 | 1 |
| 3695 85 | Basic video additional IU 7" hands free | 7990 | 1 |
| 3695 75 | Basic video additional IU 7" handset | 8740 | 1 |
| 3695 65 | Basic video additional IU 4.3" hands free | 6910 | 1 |
| 3695 55 | Basic video additional IU 4.3" handset | 7702 | 1 |
| 3695 05 | Basic audio additional handset | 3818 | 1 |
| 3695 96 | Basic additional video EP | 5698 | 1 |
| 3695 95 | Basic additional audio EP | 3222 | 1 |
| 3695 97 | Basic EP angle bracket | 700 | 1 |

* MRP - Maximum Retail Price Inclusive of all taxes including GST.
Red Cat.Nos - new products

Bold Cat.Nos are products normally available with Legrand (India) Stockists. Cat.Nos that are not bold - delivery within 4 - 8 weeks from the date of order. Bold packing quantity is our mandatory packing. Orders to be placed by Legrand (India) Stockist in multiples of the same.

D45 SYSTEM

HIGH PERFORMANCE
SIMPLIFIED

The D45 system simplifies installation in residential spaces right from a single house to a group of houses to residential complexes with a large number of apartments.



Audio handset



Slim 7" wide screen with alarm function



Entrance panels



10" Touch screen internal unit



CLASSE 300

OPEN YOUR DOOR FROM
ANYWHERE
STAY CONNECTED WITH THE CLASSE 300

WELCOME YOUR VISITORS WITH YOUR SMARTPHONE!

Connected and user-friendly, whether you are in or out of your house the new Classe 300 Door entry kit enables you to see on your smartphone who rings at your door, to talk to visitors, to open the door for them...

SIMPLE TO INSTALL

No specific cabling, no additional interface or complex setting... The installation follows the same rules as classic-2 wire system!

EASY TO CONNECT

Nothing easier than combining the Classe 300 with a smartphone

- Connection of the internal unit to the local Wi-Fi Network
- Installation of the Door Entry app (Available for free on App Store and Google Playstore) on Smartphone
- Creation of a Legrand user account
- Association of the smartphone with the new door entry system



P17 TEMPRA PRO

ALWAYS ENSURING
CONTINUITY OF SERVICE

By updating its IP44 and IP 66/67 range of industrial sockets, Legrand is meeting the expectations of professional users. New benefits in terms of safety, implementation, design & ergonomics guarantee the longevity of this family of products, which has already proven itself over time.



IP44

SOCKETS FOR INTERNAL AND EXTERNAL USE, PROTECTED AGAINST PROJECTIONS OF WATER (BUT NOT EXPOSED TO DIRECT JETS)



Straight plugs



Mobile sockets



Panel mounting sockets

A TRANSFORMED RANGE WHICH HARMONISES WITH THE LEGRAND INDUSTRIAL SOCKETS RANGE

- From 16 to 32 A
- 2 P+ E / 3 P+E / 3 P+N+E
- From 100 to 500 VA
- 50/60 Hz
- Screw connection



AIRPORTS, DATA CENTRES,
HOTELS, ETC. P17 TEMPRA PRO IS
IDEAL FOR ALL MAJOR PROJECTS

IP66/67/69*

WEATHERPROOF SOCKETS THAT
CAN WITHSTAND TEMPORARY
IMMERSION (RAIN, FLOODS, ETC)



Surface mounting
sockets

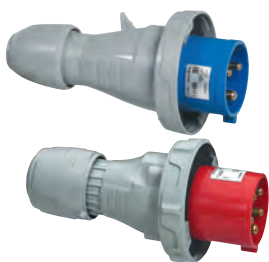

Straight plugs

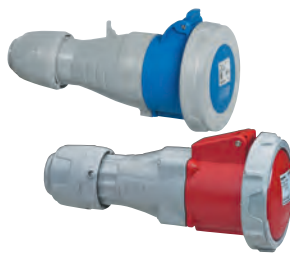

Mobile sockets



Panel mounting
sockets



Surface mounting
sockets

- From 16 to 125 A
- 2 P+ E / 3 P+E / 3 P+N+E
- From 100 to 500 VA
- 50/60 Hz
- Screw connection

* On 63 and 125 A plugs and mobile sockets

P17 TEMPRA PRO

ENSURING EASE OF USE AND SAFETY

The new P17 Tempra Pro range has been subject to extensive research in terms of design and safety in order to make life safer and easier for the user. Good product gripping, compact dimensions for use in tight spaces, easier handling, etc. Compliance with standards, anti-corrosion treated materials and components, etc. A comprehensive set of solutions which comply with the standards.

AN INNOVATIVE DESIGN THAT COMPLIES WITH STANDARDS IEC 60309-1 AND 2 AND RESPECTS THE ENVIRONMENT

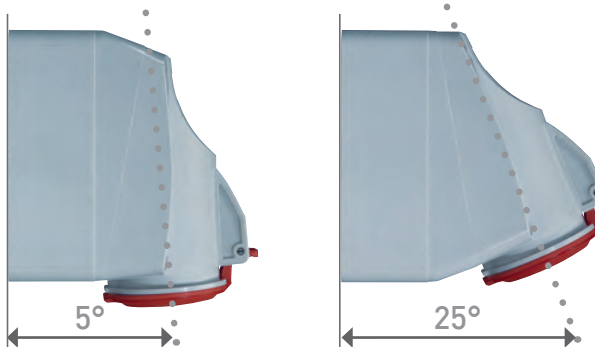

1 2 MOUNTING POSITIONS

To solve the problem of limited space, the surface mounting sockets offer 2 different mounting positions (5° or 25°) which allow users to adapt to the space available without changing the box.

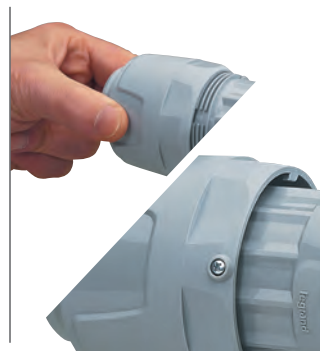

2 CABLE GRIP

Captive cable grip with anti-vibration system holds the cable in place permanently. The 63 and 125 A products are also equipped with a locking screw.



3 EASE OF HANDLING

Gripping areas on the body of the mobile products and the cable grip.

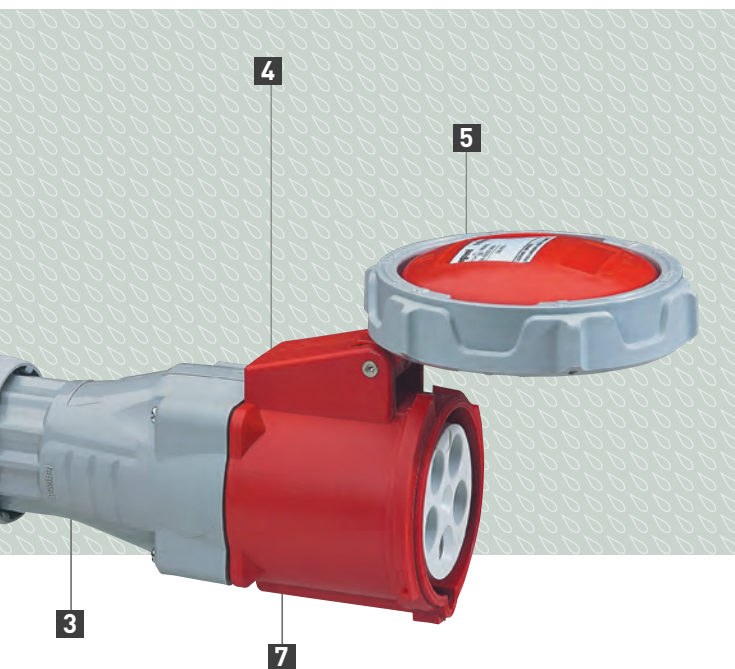

SAFETY & THE ENVIRONMENT

SAFETY

Connection terminals compliant with standards IEC 60 309 1 & 2

Production sites certified according to ISO 14001 and ISO 9001

Very high resistance to chemical products. Plugs and sockets made of polyamide 6

Anti-corrosion treated screws, stainless steel springs for the socket covers

Resistant to temperatures of -25°C to +40°C

ENVIRONMENT

Halogen-free recyclable materials (silicone, PVC) for IP 44 products

Grouped packaging in boxes

PEP products (Eco Passport)

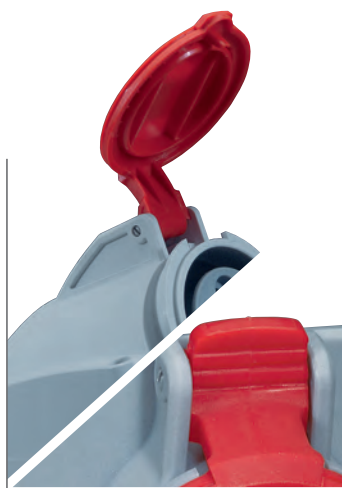

4 OPENING LEVER

For easier connection / disconnection. Cover held open on panel sockets and surface mounting sockets.



5 POSITION MARKING

Information engraved on the ring cover of IP66/67 products means the user can check quickly whether it is in the open or closed position. Marking on cover and flap for easy identification.



6 RIVETED METAL SHAFT

For 63 and 125 A products the riveted metal shaft ensures more strength. The notched locking ring facilitates the locking / unlocking operations.

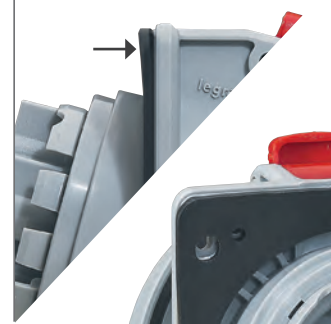

7 WEATHERPROOF SEALING

For panel mounting sockets.

P17 Tempra Pro IP 44 - LV 16 and 32 A - sockets and plugs

| Cat.Nos | Description | MRP* ₹ / Unit | Pack |
|---------|-------------|------------------|------|
|---------|-------------|------------------|------|

Surface mounting sockets

| | | | |
|---------|----------------------------|-----|----|
| 5551 54 | 200/250 V~, 16 A 2P+E | 620 | 10 |
| 5551 58 | 380/415 V~, 16 A 3P+E | 780 | 10 |
| 5551 59 | 380/415 V~, 16 A 3P+N+E | 780 | 10 |
| 5552 54 | 200/250 V~, 32 A 2P+E | 776 | 5 |
| 5552 58 | 380/415 V~, 32 A 3P+E | 988 | 10 |
| 5552 59 | 380/415 V~, 32 A 3P+N+E | 988 | 10 |

Panel mounting sockets inclined outlet

| | | | |
|---------|----------------------------|-----|----|
| 5551 84 | 200/250 V~, 16 A 2P+E | 370 | 10 |
| 5551 88 | 380/415 V~, 16 A 3P+E | 576 | 10 |
| 5551 89 | 380/415 V~, 16 A 3P+N+E | 574 | 10 |
| 5552 84 | 200/250 V~, 32 A 2P+E | 602 | 10 |
| 5552 88 | 380/415 V~, 32 A 3P+E | 764 | 10 |
| 5552 89 | 380/415 V~, 32 A 3P+N+E | 764 | 10 |

Mobile sockets

| | | | |
|---------|----------------------------|-----|----|
| 5551 04 | 200/250 V~, 16 A 2P+E | 482 | 10 |
| 5551 08 | 380/415 V~, 16 A 3P+E | 568 | 10 |
| 5551 09 | 380/415 V~, 16 A 3P+N+E | 568 | 10 |
| 5552 14 | 200/250 V~, 32 A 2P+E | 644 | 10 |
| 5552 18 | 380/415 V~, 32 A 3P+E | 814 | 10 |
| 5552 19 | 380/415 V~, 32 A 3P+N+E | 812 | 10 |

Straight plugs

| | | | |
|---------|----------------------------|-----|----|
| 5551 24 | 200/250 V~, 16 A 2P+E | 342 | 10 |
| 5551 28 | 380/415 V~, 16 A 3P+E | 442 | 10 |
| 5551 29 | 380/415 V~, 16 A 3P+N+E | 442 | 10 |
| 5552 34 | 200/250 V~, 32 A 2P+E | 536 | 10 |
| 5552 38 | 380/415 V~, 32 A 3P+E | 624 | 10 |
| 5552 39 | 380/415 V~, 32 A 3P+N+E | 624 | 10 |

P17 Tempra - domestic pin configuration 16 A - 250 V~

Flush-mounting boxes

| | | | |
|---------|---|------|---|
| 0577 21 | For 2 panel mounting sockets With single fixing centres 70 x 70 mm - 16 A | 3616 | 3 |
| 0577 22 | For 1 panel mounting socket With single fixing centres 70 x 70 mm - 16 or 32 A (32 A to be fixed horizontally) | 2168 | 3 |

* MRP - Maximum Retail Price Inclusive of all taxes including GST.

P17 Tempra Pro IP 66/67 LV 16 and 32 A

| Cat.Nos | Polarity | MRP* ₹ / Unit | Pack |
|---------|----------|------------------|------|
|---------|----------|------------------|------|

Surface mounting sockets

| | | | |
|---------|----------------------------|------|---|
| 5553 54 | 200/250 V~, 16 A 2P+E | 1008 | 5 |
| 5553 58 | 380/415 V~, 16 A 3P+E | 1178 | 5 |
| 5553 59 | 380/415 V~, 16 A 3P+N+E | 1280 | 5 |
| 5554 54 | 200/250 V~, 32 A 2P+E | 1140 | 5 |
| 5554 55 | 200/250 V~, 32 A 3P+E | 2166 | 5 |
| 5554 59 | 380/415 V~, 32 A 3P+N+E | 2348 | 5 |

Panel mounting sockets

| | | | |
|---------|----------------------------|------|---|
| 5553 84 | 200/250 V~, 16 A 2P+E | 736 | 5 |
| 5553 88 | 380/415 V~, 16 A 3P+E | 824 | 5 |
| 5553 89 | 380/415 V~, 16 A 3P+N+E | 824 | 5 |
| 5554 84 | 200/250 V~, 32 A 2P+E | 938 | 5 |
| 5554 88 | 380/415 V~, 32 A 3P+E | 1126 | 5 |
| 5554 89 | 380/415 V~, 32 A 3P+N+E | 1126 | 5 |

Mobile sockets

| | | | |
|---------|----------------------------|------|---|
| 5553 04 | 200/250 V~, 16 A 2P+E | 902 | 5 |
| 5553 08 | 380/415 V~, 16 A 3P+E | 1178 | 5 |
| 5553 09 | 380/415 V~, 16 A 3P+N+E | 1178 | 5 |
| 5554 14 | 200/250 V~, 32 A 2P+E | 1238 | 5 |
| 5554 18 | 380/415 V~, 32 A 3P+E | 1388 | 5 |
| 5554 19 | 380/415 V~, 32 A 3P+N+E | 1392 | 5 |

Straight plugs

| | | | |
|---------|----------------------------|------|---|
| 5553 24 | 200/250 V~, 16 A 2P+E | 784 | 5 |
| 5553 28 | 380/415 V~, 16 A 3P+E | 902 | 5 |
| 5553 29 | 380/415 V~, 16 A 3P+N+E | 906 | 5 |
| 5554 34 | 200/250 V~, 32 A 2P+E | 1114 | 5 |
| 5554 38 | 380/415 V~, 32 A 3P+E | 1172 | 5 |
| 5554 39 | 380/415 V~, 32 A 3P+N+E | 1172 | 5 |

P17 Tempra Pro IP 66/67 LV 32 A for refrigerated containers

Combined unit, plug and mobile socket for refrigerated containers

| | | | |
|---------|--|-------|---|
| 6571 06 | Combined unit with interlocked switched socket - Double mechanical interlock - Cable glands are not supplied | 16714 | 1 |
|---------|--|-------|---|

Bold Cat.Nos are products normally available with Legrand (India) Stockists. Cat.Nos that are not bold - delivery within 4 - 8 weeks from the date of order. Bold packing quantity is our mandatory packing. Orders to be placed by Legrand (India) Stockist in multiples of the same.

P17 Tempra Pro IP 66/67 LV 32 A for refrigerated containers

| Cat.Nos | Polarity | MRP* ₹ / Unit | Pack |
|---------|----------|------------------|------|
|---------|----------|------------------|------|

Combined unit, plug and mobile socket for refrigerated containers

| | | | |
|---------|--|------|---|
| 5554 91 | Panel mounting socket | 1382 | 5 |
| 5554 21 | Mobile socket with cable grip Ø12 to 21.5 mm | 1674 | 5 |
| 5554 41 | Straight plug With cable grip Ø12 to 21.5 mm | 1346 | 5 |

P17 Tempra Pro IP 66/67 - LV 63 and 125 A

Surface mounting sockets

| | | | |
|---------|--------------------------|-------|---|
| 5555 54 | 200/250 V~, 63 A 2P+E | 4376 | 2 |
| 5555 58 | 380/415 V~, 63 A 3P+E | 4354 | 2 |
| 5555 59 | 380/415 V~, 63 A 3P+N+E | 4354 | 2 |
| 5556 58 | 380/415 V~, 125 A 3P+E | 12676 | 2 |
| 5556 59 | 380/415 V~, 125 A 3P+N+E | 12676 | 2 |

Panel mounting sockets

| | | | |
|---------|--------------------------|-------|---|
| 5555 84 | 200/250 V~, 63 A 2P+E | 3470 | 2 |
| 5555 88 | 380/415 V~, 63 A 3P+E | 3540 | 2 |
| 5555 89 | 380/415 V~, 63 A 3P+N+E | 3328 | 2 |
| 5556 88 | 380/415 V~, 125 A 3P+E | 10018 | 1 |
| 5556 89 | 380/415 V~, 125 A 3P+N+E | 9916 | 1 |

Straight plugs

| | | | |
|---------|--------------------------|------|---|
| 5555 24 | 200/250 V~, 63 A 2P+E | 2940 | 2 |
| 5555 28 | 380/415 V~, 63 A 3P+E | 2984 | 2 |
| 5555 29 | 380/415 V~, 63 A 3P+N+E | 3086 | 2 |
| 5556 28 | 380/415 V~, 125 A 3P+E | 8886 | 1 |
| 5556 29 | 380/415 V~, 125 A 3P+N+E | 8886 | 1 |

Mobile sockets

| | | | |
|---------|--------------------------|-------|---|
| 5555 04 | 200/250 V~, 63 A 2P+E | 3750 | 2 |
| 5555 08 | 380/415 V~, 63 A 3P+E | 3710 | 2 |
| 5555 09 | 380/415 V~, 63 A 3P+N+E | 3938 | 2 |
| 5556 08 | 380/415 V~, 125 A 3P+E | 12934 | 1 |
| 5556 09 | 380/415 V~, 125 A 3P+N+E | 12934 | 1 |

Plugs and sockets

| Cat.Nos | Polarity | MRP* ₹ / Unit | Pack |
|---------|----------|------------------|------|
|---------|----------|------------------|------|

P17 combined unit to be equipped

Bases with mechanical super-compact sockets

| | | | |
|---------|---|------|---|
| 0573 00 | 16 A, 2P+E IP 44 Interlock | 4418 | 1 |
| 0573 02 | 16 A, 3P+N+E IP 44 Interlock | 4876 | 1 |
| 0573 20 | 16 A, 2P+E IP 55 Interlock | 4958 | 1 |
| 0573 22 | 16 A, 3P+N+E IP 55 Interlock | 5578 | 1 |
| 0577 23 | Mounting plate for 2 super-compact mechanical interlock sockets | 2480 | 1 |

Bases for 125 x 220 mm face plates

Example of combined unit configuration

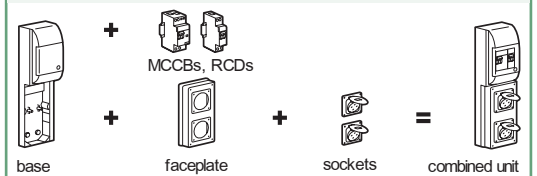

| | | | |
|---------|--|------|---|
| 0577 10 | Surface mounting box - upto 2 sockets | 976 | 2 |
| 0589 38 | Surface mounting box with 5 module dinrail - upto 2 sockets | 2752 | 1 |
| 0577 05 | Surface mounting box with 12 module dinrail - upto 4 sockets | 6018 | 1 |
| 0577 06 | Surface mounting box with 18 module dinrail - upto 6 sockets | 8424 | 1 |

Face plates 125 x 220 mm without sockets

| | | | |
|---------|------------------------------------|------|---|
| 0577 12 | For 1 x 16 A or 32 - upto A socket | 934 | 5 |
| 0577 13 | For 2 x 16 A - upto sockets | 1232 | 5 |
| 0577 17 | For 1 x 63 A - upto sockets | 1130 | 5 |
| 0577 15 | Blanking Plate | 832 | 5 |

Bases for 125 x 280 mm faceplates

| | | | |
|---------|--|------|---|
| 0577 11 | Surface mounting box - upto 3 sockets | 1016 | 3 |
| 0577 20 | Surface mounting box with 5 module dinrail - upto 3 sockets | 3098 | 1 |
| 0577 03 | Surface mounting box with 12 module dinrail - upto 6 sockets | 6240 | 1 |
| 0577 04 | Surface mounting box with 18 module dinrail - upto 9 sockets | 8680 | 1 |

* MRP - Maximum Retail Price Inclusive of all taxes including GST.

Bold Cat.Nos are products normally available with Legrand (India) Stockists. Cat.Nos that are not bold - delivery within 4 - 8 weeks from the date of order. Bold packing quantity is our mandatory packing. Orders to be placed by Legrand (India) Stockist in multiples of the same.

Plugs and sockets

| Cat.Nos | Polarity | MRP* ₹ / Unit | Pack |
|---------|----------|------------------|------|
|---------|----------|------------------|------|

Face plates 125 x 280 mm without sockets

| | | | |
|---------|---|------|---|
| 0577 18 | For 2 x 16 A and / or 32 A sockets | 1464 | 4 |
| 0577 19 | For 1 x 16 A or 32 A socket and 1 x 63 A socket | 1446 | 2 |
| 0577 14 | For 3 x 16 A sockets | 1670 | 4 |
| 0577 16 | Blanking plate | 976 | 4 |

Hypra industrial plugs and sockets

Sockets

Prisinter panel mounting sockets - IP 44, IK 09

| | | | |
|---------|---------------------|-------|------|
| 0520 02 | 230 V, 16 A, 2P+E | 12336 | 1/10 |
| 0527 02 | 230 V, 32 A, 2P+E | 13322 | 1/6 |
| 0529 03 | 415 V, 32 A, 3P+E | 13656 | 1/6 |
| 0529 04 | 415 V, 32 A, 3P+N+E | 16226 | 1/6 |
| 0536 04 | 415 V, 63 A, 3P+N+E | 41594 | 1 |

Panel mounting sockets - inclined IP 44, IK 09

| | | | |
|---------|-------------------|------|------|
| 0522 23 | 415 V, 16 A, 3P+E | 1986 | 5/50 |
| 0538 23 | 415 V, 63 A, 3P+E | 6204 | 1 |

Mobile sockets - IP 44, IK 09

| | | | |
|---------|-------------------|------|------|
| 0522 83 | 415 V, 16 A, 3P+E | 4752 | 5/50 |
|---------|-------------------|------|------|

Plugs

Straight plugs - IP 44, IK 09

| | | | |
|---------|---------------------|-------|------|
| 0520 42 | 250 V, 16 A, 2P+E | 2036 | 5/50 |
| 0527 42 | 250 V, 32 A, 2P+E | 2676 | 1/5 |
| 0522 43 | 415 V, 16 A, 3P+E | 3532 | 5/50 |
| 0529 43 | 415 V, 32 A, 3P+E | 3358 | 5/50 |
| 0529 44 | 415 V, 32 A, 3P+N+E | 3720 | 5/15 |
| 0538 43 | 415 V, 63 A, 3P+E | 8878 | 1/5 |
| 0538 44 | 415 V, 63 A, 3P+N+E | 11928 | 1/5 |

Metra plugs and sockets

Plugs

Ivory

| | | | |
|---------|-------------------|-----|---------|
| 6500 22 | 240 V, 10 A, 2P+E | 164 | 1/5/100 |
| 6500 28 | 240 V, 20 A, 2P+E | 174 | 1/5/100 |

Grey

| | | | |
|---------|-------------------|-----|---------|
| 6500 02 | 240 V, 10 A, 2P+E | 164 | 1/5/100 |
| 6500 08 | 240 V, 20 A, 2P+E | 174 | 1/5/100 |
| 6500 10 | 440 V, 20 A, 3P+E | 232 | 1/5/100 |
| 6500 16 | 440 V, 32 A, 3P+E | 434 | 1/5/100 |

Sockets

| | | | |
|---------|-------------------------------------|-----|---------|
| 6500 03 | 240 V, 10 A, 2P+E With blue cap | 168 | 1/5/100 |
| 6500 23 | 240 V, 10 A, 2P+E With ivory cap | 168 | 1/5/100 |

Hypra industrial plugs and sockets

| Cat.Nos | Description | MRP* ₹ / Unit | Pack |
|---------|-------------|------------------|------|
|---------|-------------|------------------|------|

Sockets

| | | | |
|---------|-------------------------------------|-----|---------|
| 6500 09 | 240 V, 20 A, 2P+E With blue cap | 192 | 1/5/100 |
| 6500 29 | 240 V, 20 A, 2P+E With ivory cap | 192 | 1/5/100 |
| 6500 11 | 440 V, 20 A, 3P+E With red cap | 258 | 1/5/100 |
| 6500 17 | 440 V, 32 A, 3P+E With red cap | 434 | 1/5/100 |

Plugs and sockets

P17 tempra combined units

With interlocked switched sockets and surface mounting box IP 44

| | | | |
|---------|---------------------|------|---|
| 0566 01 | 250 V, 16 A, 2P+E | 6634 | 1 |
| 0566 09 | 250 V, 32 A, 2P+E | 7916 | 1 |
| 0566 13 | 415 V, 32 A, 3P+E | 9574 | 1 |
| 0566 14 | 415 V, 32 A, 3P+N+E | 9482 | 1 |

With interlocked switched sockets and surface mounting box IP 55

| | | | |
|---------|---------------------|-------|---|
| 0566 21 | 250 V, 16 A, 2P+E | 7370 | 1 |
| 0566 29 | 250 V, 32 A, 2P+E | 8422 | 1 |
| 0566 33 | 415 V, 32 A, 3P+E | 10676 | 1 |
| 0566 34 | 415 V, 32 A, 3P+N+E | 10254 | 1 |

With interlocked switched sockets and surface mounting box IP 44 with DIN rail for 5 module DX³ protection

| | | | |
|---------|---------------------|------|---|
| 0566 41 | 250 V, 16 A, 2P+E | 6678 | 1 |
| 0566 49 | 250 V, 32 A, 2P+E | 8122 | 1 |
| 0566 53 | 415 V, 32 A, 3P+E | 9522 | 1 |
| 0566 54 | 415 V, 32 A, 3P+N+E | 9434 | 1 |

With interlocked switched sockets and surface mounting box IP 66 with DIN rail for 5 module DX³ protection

| | | | |
|---------|---------------------|-------|---|
| 0566 61 | 250 V, 16 A, 2P+E | 7482 | 1 |
| 0566 69 | 250 V, 32 A, 2P+E | 8682 | 1 |
| 0566 73 | 415 V, 32 A, 3P+E | 9934 | 1 |
| 0566 74 | 415 V, 32 A, 3P+N+E | 10130 | 1 |

With interlocked switched sockets and without surface mounting box IP 55

| | | | |
|---------|----------------------------|-------|---|
| 0572 21 | 250 V, 16 A, 2P+E | 6380 | 1 |
| 0572 29 | 250 V, 32 A, 2P+E | 7214 | 1 |
| 0572 33 | 415 V, 32 A, 3P+E | 8566 | 1 |
| 0572 34 | 415 V, 32 A, 3P+N+E | 9356 | 1 |
| 0572 95 | 415 V, 63 A, 3P+N+E, IP 66 | 26288 | 1 |
| 0577 00 | Base box for 0572 95 | 3642 | 1 |

P17 tempra combined units

with interlocked switched sockets IP 66

| | | | |
|---------|---|-------|---|
| 0589 18 | 380 to 415 V, 50/60 Hz, 63 A, 3P + E with provision for 5 module DX ³ protection | 28440 | 1 |
| 0572 99 | 380 to 415 V, 50/60 Hz, 63 A, 3P+N+E with provision for 5 module DX ³ protection | 29762 | 1 |

* MRP - Maximum Retail Price Inclusive of all taxes including GST.

Bold Cat.Nos are products normally available with Legrand (India) Stockists. Cat.Nos that are not bold - delivery within 4 - 8 weeks from the date of order. Bold packing quantity is our mandatory packing. Orders to be placed by Legrand (India) Stockist in multiples of the same.

LEGRAND

A GLOBAL EDIFICE

Legrand is global specialist in electrical and digital building infrastructures. The Group's headquarter is based at Limoges, France. Legrand (India), the pioneer of Miniature Circuit Breakers in India, is the Indian subsidiary of Legrand Group. The Group services the needs of residential, commercial, hospitality and industrial sectors.

- Manufacturing facilities in 90 countries and sale of products in 180 countries.
- World leader in wiring devices and cable management.
- The group designs and manufactures over 100 product families comprising of 3,00,000 products annually, with due emphasis on high performance, simplified installation and user convenience.
- Close to 1/3 of Legrand's capital expenditure is dedicated to the development of new products.
- Every year, Legrand invests around 4.8% of its global turnover on research and development activities involving over 2100 people worldwide.
- More than 100 showrooms around the globe.



Building trust with 37,000 employees



Sharing the legacy of over 6 billion euros turnover in the year 2017

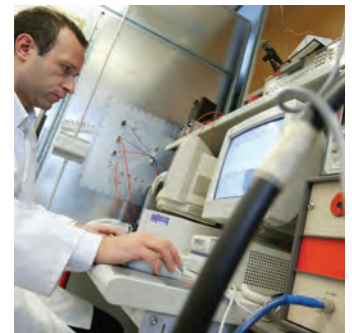

Understanding you through 3,00,000 products

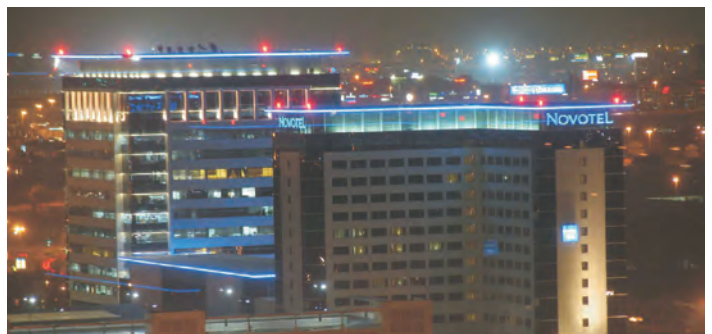

Partnering you with more than 3700 active patents

LEGRAND

GROUP VALUES

1

CUSTOMER
AWARENESS



2

INNOVATION



3

RESOURCE
ENHANCEMENT



4

ETHICAL
BEHAVIOUR



LEGRAND

PRESTIGIOUS PROJECTS

- Some of the prestigious projects we have been proud to associate with.
- The group services the needs of residential, commercial, hospitality and industrial projects.

NORTH



The Atulya Heights
(Deepsons India)



Jayshree Periwal
International School

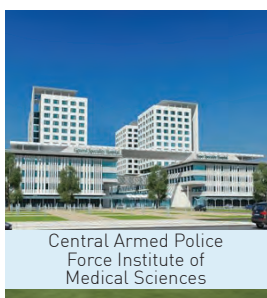

Central Armed Police
Force Institute of
Medical Sciences

EAST



Saha Institute of
Nuclear Physics



SSKM Trauma Centre



The 42

WEST



Capital City



Baramati Medical
College & Hospital



BPCL Bharat Bhavan 2 –
IGBC Gold Rating

SOUTH



Panimalar Medical
College



Bowring and Lady Curzon
Hospital

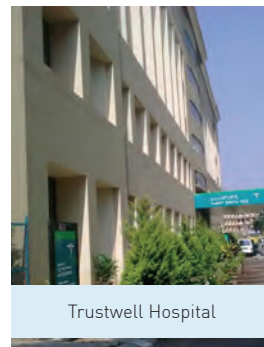

Trustwell Hospital

CENTRAL



Honor Homes - Vivantis



Telangana Police HQ



Andhra Pradesh -
High Court

Warranty policy

Legrand warrants to the original purchaser that the Products (excluding any third party products purchased through Legrand, for which no warranties are made) will be free from defects in material and workmanship, under normal use and regular service, and preventative maintenance for a period of 18 months from the date of shipment or 12 months from the date of installation whichever is earlier. Should any failure to conform with this warranty be found during the Warranty Period, you must notify Legrand of your claim within thirty (30) days of discovery, and within the Warranty Period. Your failure to give notice of claims of breach of warranty within the Warranty Period shall be deemed an absolute and unconditional waiver of claims for such defects. Legrand will have no responsibility to honour claims received after the date the applicable Warranty Period expires. The invoice / bill in original must be produced without which warranty claim shall not be entertained.

This warranty does not cover the following:

- Defect caused due to misuse, alteration, faulty installation, faulty electrical systems, negligent maintenance or misapplication of the product.
- Failure of product or components due to any act of nature; lightning strike, floods, hurricanes, tornadoes, etc. beyond the control of human being.
- Legrand does not warrant any third party products or associated hardware or their performance or suitability for use and application. Such items are provided "as-is".

Extended warranty policy is applicable for following products,

1. DX³ & RX³ MCB – 5 years if mounted inside Legrand DB
2. Arteor™, Myrius™, Mylinc™, Britzy™ switches (without neon lamp) & Power sockets – 10 years
3. Arteor™, Myrius™, Mylinc™, Britzy™ other products – 2 years

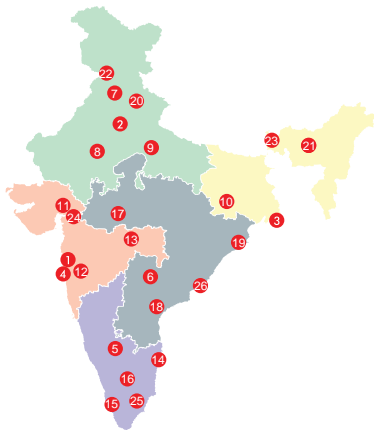

Head offices

- 61 & 62, 6th Floor,
Kalpataru Square, Kondivita Road,
Off Andheri-Kurla Road, Andheri (E),
MUMBAI – 400 059.
Tel : (022) 3041 6200
Fax : (022) 3041 6201
Website : www.legrand.co.in

Regional sales offices

- A-25, Mohan Co-operative
Industrial Estate, Mathura Road,
NEW DELHI – 110 044.
Tel : (011) 3990 2200, 2699 0046,
(011) 2699 0028 / 29 / 30 / 31
Fax : (011) 2699 0047
- Bhakta Towers, 2nd & 3rd Floor,
Plot No. KB 22, Sector-III, Saltlake,
KOLKATA – 700 098.
Tel : (033) 4021 3535 / 36
Fax : (033) 4021 3537
- C/203, Corporate Avenue, Atul Projects,
Near Mirador Hotel, Chakala,
Andheri Ghatkopar Link Road,
Andheri – East, **MUMBAI** – 400 099.
Tel : (022) 3385 6200 / 62301000 **INNOVAL**
- Ferozes Manor,
Situated at 58 Hospital Road,
Shivaji Nagar,
BANGALORE – 560 001.
Tel : (080) 6822 0000 **INNOVAL**
- 205-208, 2nd Floor, Block - II,
White House, Kundan Bagh,
Begumpet,
HYDER ABAD – 500 016.
Tel : (040) 2341 4398 / 67, 4567 1717
Fax : (040) 4567 1730

Branch offices

- Unit 203, 2nd Floor, Tower- B,
Bestech Business Tower, Sector 66,
Mohali, **CHANDIGARH**-160066.
Telefax : (0141) 2208665, 666 **INNOVAL**
- 507-510, 5th Floor, Soni Paris Point,
Jai Singh Highway, Banipark,
JAIPUR- 302 016.
Tel / Fax : (0141) 220 8665 / 666
- 209-A, 2nd Floor, Cyber Heights,
Opp. Indira Gandhi Pratishthan,
Vibhuti Khand, Gomti Nagar
LUCKNOW- 226 010.
Tel : (522) 319 2031 / 32 / 33 **INNOVAL**
- 202 & 203, 2nd Floor, Sunrise,
Forum 100, Burdwan Compound, Lalpur,
RANCHI – 834 001.
Tel : (651) 660 5400
- A 101-102, Mondeal Heights,
Besides Novotel Hotel, Sarkhej
Gandhinagar Highway (S G Highway),
AHMEDABAD – 380 015.
Tel : (079) 6134 0555 **INNOVAL**
- 402, Swastik Chambers,
Near Ashwamegh Marriage Hall,
Behind HP Petrol Pump,
Off Karve Road, Erandwane,
PUNE – 411 004.
Tel : (020) 6729 5601 / 602
Fax : (020) 6729 5604
- Plot No.95, II Floor, Shreyash Heights,
VIP Road, Ramdaspath,
NAGPUR – 440 010.
Tel : (0712) 662 7857 / 858
Fax : (0712) 662 7859
- 10 B, (10th Floor), Prestige Center Court
Office Block Vijaya Forum Mall, #183,
N.S.K. Salai, Vadapalani
CHENNAI – 600 026.
Tel : (044) 6612 2800 / 2362 3125 / 35 / 45
Fax : (044) 2362 3165 **INNOVAL**
- J. B. Manjooran Estate,
Door No 50/1107A9, 3rd Floor,
Bye Pass Junction, Edappally,
COCHIN – 682 024.
Tel : (0484) 280 1921 / 2921, 658 0921
Fax : (0484) 280 1921 / 2921 **INNOVAL**
- B-5, 1st Floor, Thirumalai Towers,
723, Avanashi Road,
COIMBATORE – 641 018.
Tel : (0422) 222 3634 / 0283
Fax : (0422) 222 3164 **INNOVAL**
- 204-205, Megapolis Square,
579, M G Road,
INDORE – 452 001.
Tel : (0731) 4999 891 / 892

- MF-2, Datta's Lords House,
Jamma Chettu Street, Mogalrajapuram,
VIJAYAWADA – 520 010.
Tel : (0866) 248 2393/6393/5393
- Plot No. 359, Saheed Nagar,
2nd Floor,
BHUBANESWAR – 751 007.
Tel : (0674) 254 0623
- Unit - 1 & 2, Vijay Park,
Main Chakrata Road,
DEHRADUN- 248 001.
Uttarakhand.
Tel : (0135) 661 6100 **INNOVAL**
- House No. 97, Ground Floor,
Rajgarh Main Road,
Opp. City Heart Nursing Home,
GUWAHATI – 781 007.
Tel : (0361) 245 8498

Area offices

- Cabin No. 9, Second Floor,
Madhok Trade Centre,
Madhok Complex, Ferozpur Road,
LUDHIANA – 141 001.
Tel : (0161) 277 0301 / 2 / 3 / 4
- 94, Udham Singh Sarani,
Ground Floor, Ashrampara,
SILIGURI – 734 001.
Tel : (0353) 264 1067
- 405, City Centre, Sosyo Circle,
Udhana Magdalla Road,
SURAT - 395 002.
Tel : (0261) 263 3861
- Aparna Towers, 1st Floor, 2/3,
Bypass Road,
MADURAI – 625 010.
Telefax : (0452) 230 8414
- 43-9-205, Near srikanya theatre
3rd floor, Plot No 10, Subbalaskhmi
Nagar, Allipuram Ward,
Dondapar thy Area,
VISHAKAPATHANAM – 530 016.
Tel : (0891) 663 5652 / 663 9363 **INNOVAL**

Technical assistance from Legrand

Telephonic technical assistance for selection of products, technical information, guidance, wiring diagrams and estimation is now made available to you at each Regional Office. Contact the Technical Officer of Legrand at the following telephone numbers

- New Delhi** : Tel.: (011) 2699 0028, 3990 2200
Kolkata : Tel.: (033) 4021 3535 / 36
Mumbai : Tel.: (022) 3385 6200
Chennai : Tel.: (044) 3024 7200
Hyderabad : Tel.: (040) 2341 4398 / 67, 4567 1717

For other places, contact the nearest
Regional / Branch / Area offices

customer.care@legrand.co.in

